

FUJIFILM

DIGITAL CAMERA

IS Pro

OWNER'S MANUAL

This manual will show you how to use your FUJIFILM DIGITAL CAMERA IS Pro correctly. Please follow the instructions carefully.

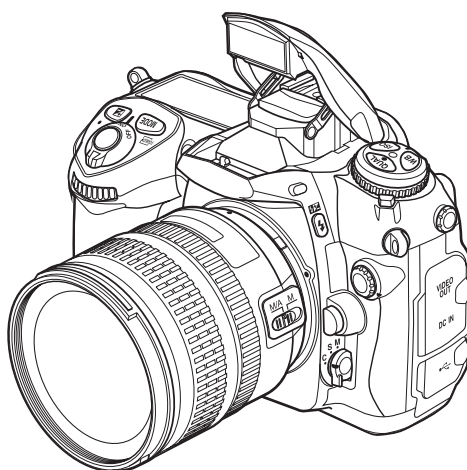

Getting Ready

Using the Camera

Advanced Features • Photography

• Playback

Settings

Camera Connection

Software
Installation

Appendices

Troubleshooting



FZ07044-100 

Warning

To prevent fire or shock hazard, do not expose the unit to rain or moisture.

For customers in the U.S.A.

*Tested To Comply
With FCC Standards
FOR HOME OR OFFICE USE*

FCC Statement

This device complies with Part 15 of the FCC Rules. Operation is subject to the following two conditions: (1) This device may not cause harmful interference, and (2) this device must accept any interference received, including interference that may cause undesired operation.

CAUTION

This equipment has been tested and found to comply with the limits for a Class B digital device, pursuant to Part 15 of the FCC Rules. These limits are designed to provide reasonable protection against harmful interference in a residential installation. This equipment generates, uses, and can radiate radio frequency energy and, if not installed and used in accordance with the instructions, may cause harmful interference to radio communications. However, there is no guarantee that interference will not occur in a particular installation. If this equipment does cause harmful interference to radio or television reception, which can be determined by turning the equipment off and on, the user is encouraged to try to correct the interference by one or more of the following measures:

- Reorient or relocate the receiving antenna.
- Increase the separation between the equipment and receiver.
- Connect the equipment into an outlet on a circuit different from that to which the receiver is connected.
- Consult the dealer or an experienced radio/TV technician for help.

You are cautioned that any changes or modifications not expressly approved in this manual could void the user's authority to operate the equipment.

Notes on the Grant:

To comply with Part 15 of the FCC Rules, this product must be used with a Fujifilm-specified ferrite-core A/V cable, USB cable, and DC supply cord.

For customers in Canada

CAUTION

This Class B digital apparatus complies with Canadian ICES-003.

Please read the Safety Notes (→p.238) and make sure you understand them before using the camera.

**Perchlorate Material-special handling may apply,
See <http://www.dtsc.ca.gov/hazardouswaste/perchlorate>.**

IMPORTANT

Be sure to read this page before using the software.

NOTICE

BEFORE OPENING THE CD-ROM PROVIDED BY FUJIFILM Corporation, PLEASE READ THIS END USER LICENSE AGREEMENT CAREFULLY. ONLY IF YOU AGREE WITH THIS AGREEMENT, SHOULD YOU USE THE SOFTWARE RECORDED ON THE CD-ROM. BY OPENING THE PACKAGE, YOU ACCEPT AND AGREE TO BE BOUND BY THIS AGREEMENT.

End User License Agreement

This End User License Agreement ("Agreement") is an agreement between FUJIFILM Corporation ("FUJIFILM") and you, which sets forth the terms and conditions of the license granted for you to use the software provided by FUJIFILM.

The CD-ROM contains third party software. In case a separate agreement is provided by a third party supplier for its software, the provisions of such separate agreement shall apply to the use of such third party software, prevailing over those of this Agreement.

1. Definitions.

- (a) "Media" means the CD-ROM titled "Software for FinePix CX" - which is provided to you together with this Agreement.
- (b) "Software" means the software which is recorded on Media.
- (c) "Documentation" means the operation manuals of Software and other related written materials which are provided to you together with Media.
- (d) "Product" means Media (including Software) and Documentation collectively.

2. Use of Software.

FUJIFILM grants to you a nontransferable, nonexclusive license:

- (a) to install one copy of Software onto one computer in binary machine executable form;
- (b) to use Software on the computer onto which Software is installed; and
- (c) to make one backup copy of Software.

3. Restrictions.

- 3.1 You shall not distribute, rent, lease or otherwise transfer all or any part of Software, Media or Documentation to any third party without FUJIFILM's prior written consent. You also shall not sublicense, assign or otherwise transfer all or any part of the rights granted to you by FUJIFILM under this Agreement without FUJIFILM's prior written consent.
- 3.2 Except as expressly granted by FUJIFILM hereunder, you shall not copy or reproduce all or any part of Software or Documentation.
- 3.3 You shall not modify, adapt or translate Software or Documentation. You also shall not alter or remove copyright and other proprietary notices that appear on or in Software or Documentation.
- 3.4 You shall not, or shall not have any third party, reverse-engineer, decompile, or disassemble Software.

4. Ownership.

All copyrights and other proprietary rights to Software and Documentation are owned and retained by FUJIFILM or the third party suppliers as indicated on or in Software or Documentation. Nothing contained herein shall be construed, expressly or implicitly, as transferring or granting any right, license, or title to you other than those explicitly granted under this Agreement.

5. Limited Warranty.

FUJIFILM warrants to you that Media is free from any defect in material and workmanship under normal use for ninety (90) days from the date of your receipt of Media. Should Media not meet the foregoing warranty, FUJIFILM shall replace such defective Media with other Media bearing no defect. FUJIFILM's entire liability and your sole and exclusive remedy with regard to any defect in Media shall be expressly limited to such FUJIFILM's replacement of Media as provided herein

6. DISCLAIMER OF WARRANTY.

EXCEPT AS PROVIDED IN SECTION 5 HEREIN, FUJIFILM PROVIDES PRODUCT "AS IS" AND WITHOUT WARRANTIES OF ANY KIND, EXPRESS OR IMPLIED. FUJIFILM SHALL MAKE NO WARRANTY, EXPRESS, IMPLIED OR STATUTORY, AS TO ANY OTHER MATTERS, INCLUDING, BUT NOT LIMITED TO NON-INFRINGEMENT OF ANY COPYRIGHT, PATENT, TRADE SECRET, OR ANY OTHER PROPRIETARY RIGHTS OF ANY THIRD PARTY, MERCHANTABILITY, OR FITNESS FOR ANY PARTICULAR PURPOSE.

7. LIMITATION OF LIABILITY.

IN NO EVENT SHALL FUJIFILM HAVE ANY LIABILITY FOR ANY GENERAL, SPECIAL, DIRECT, INDIRECT, CONSEQUENTIAL, INCIDENTAL, OR OTHER DAMAGES (INCLUDING DAMAGES FOR LOSS OF PROFITS OR LOST SAVINGS) INCURRED FROM THE USE OF OR INABILITY TO USE PRODUCT EVEN IF FUJIFILM HAS BEEN ADVISED OF THE POSSIBILITY OF SUCH DAMAGES.

8. No export.

You acknowledge that neither Software nor any part thereof, will be transferred, or exported to any country or used in any manner in violation of any export control laws and regulations to which Software is subject.

9. Termination.

In case you breach any of the terms and conditions hereof, FUJIFILM may immediately terminate this Agreement without any notice.

10. Term.

This Agreement is effective until the date when you cease to use Software, unless earlier terminated in accordance with Section 9 hereof.

11. Obligation upon termination.

Upon termination or expiration of this Agreement, you shall, at your own responsibility and expense, delete or destroy immediately all Software (including its copies), Media and Documentation.

12. Governing Law.

This Agreement shall be governed by and construed in accordance with laws of Japan.

EC Declaration of Conformity

We
Name: FUJIFILM Europe GmbH
Address: Heesenstrasse 31
40549 Dusseldorf, Germany

declare that the product
Product Name: FUJIFILM DIGITAL CAMERA IS Pro
Manufacturer's Name: FUJIFILM Corporation
Manufacturer's Address: 7-3, AKASAKA 9-CHOME, MINATO-KU,
TOKYO 107-0052, JAPAN

conforms to the following Standards:
Safety: EN60065
EMC: EN55022: 1998 Classe B
EN55024: 1998
EN61000-3-2: 1995 + A1: 1998 + A2: 1998

following the provision of the EMC Directive (89/336/EEC, 92/31/EEC)
and Low Voltage Directive (2006/95/EC).



Dusseldorf, Germany

January 1, 2007

Place

Date

Signature/Managing Director



This product comes with batteries. When these are empty, you shouldn't throw them away but deliver them as domestic chemical refuse.

Disposal of Electric and Electronic Equipment in Private Households

Disposal of used Electrical & Electronic Equipment (Applicable in the European Union and other European countries with separate collection systems)



This symbol on the product, or in the manual and in the warranty, and/or on its packaging indicates that this product shall not be treated as household waste. Instead it should be taken to an applicable collection point for the recycling of electrical and electronic equipment.

By ensuring this product is disposed of correctly, you will help prevent potential negative consequences to the environment and human health, which could otherwise be caused by inappropriate waste handling of this product.

If your equipment contains easy removable batteries or accumulators please dispose these separately according to your local requirements.

The recycling of materials will help to conserve natural resources. For more detailed information about recycling of this product, please contact your local city office, your household waste disposal service or the shop where you have purchased the product.

In Countries outside the EU:

If you wish to discard this product, please contact your local authorities and ask for the correct way of disposal.

Contents

Warning.....	2
IMPORTANT	3
EC Declaration of Conformity.....	4
Disposal of Electric and Electronic Equipment in Private Households	5
Contents.....	6
Preface.....	9
About this Manual	11
Accessories Included	12
Camera Parts and Features.....	13
Example of Control Panel, Viewfinder and LCD Monitor.....	17

Getting Ready

Attaching the Strap and Lens.....	23
Attaching the strap	23
Mounting the camera lens.....	23
Attaching the LCD cover	29
Charging the Battery	30
Loading the Battery.....	32
Checking the battery charge	33
Inserting Memory Cards.....	34
Formatting the memory card.....	35
Turning On and Off	36
Setting the language, date, and time	36
Correcting the Date and Time	39
Adjusting Viewfinder Focus.....	40
Selecting the Language	41

Using the Camera

Basic Operation Guide	42
-----------------------------	----

Taking Pictures at Default Settings	47
Viewing the Images	50
Setting the camera to playback mode.....	50
Single-frame playback.....	51
Multi-frame playback	53
Using the erase button	53

Advanced Features — Photography

Focus.....	54
Focus mode	54
AF-area mode	55
Focus zone selection	57
Focus area selection	59
Manual focus.....	60
Focus lock	61
Getting good results with autofocus	63
The AF-assist illuminator.....	64
Depth-of-field preview button	65
Release	66
Metering	68
Taking Pictures with AE Lock.....	69
Exposure Mode	70
P Programmed auto.....	70
S Shutter-priority auto	72
A Aperture-priority auto	73
M Manual.....	74
Exposure compensation.....	76
Flash Photography	78
Built-in flash.....	78
Using the Built-in flash	79
Synchro modes and their features	82

Flash exposure compensation	84
FV lock	85
Lenses that can be used with the built-in flash.....	87
Nikon Speedlights that can be used	88
Changing the Sensitivity Setting (ISO ISO).....	92
Changing the Image Quality Setting (QUALITY).....	93
Changing the Image Size Setting (RECORDING PIXELS).....	94
Adjusting Color Balance (WB WHITE BALANCE).....	95
[CHOOSE COLOR TEMP.]	97
[WB FINE TUNE]	98
Preset White Balance	99
Self-Timer Mode.....	101
Using Auto Bracketing	103
Using SHOOTING MENU	108
Setting the [SHOOTING MENU].....	108
List of [SHOOTING MENU] options	109
SHOOTING MENU	111
[FILM SIMULATION].....	111
[D-RANGE]	112
[COLOR]	113
[TONE].....	113
[SHARPNESS].....	114
[RGB] COLOR SPACE	114
[MULTIPLE EXPOSURE]	115
[LIVE VIEW DISPLAY].....	117
[SHOOTING MENU RESET]	119
[NOISE REDUCTION]	119

Two-Button Reset.....	120
Non-CPU Lenses	121
Specifying lens focal length.....	122
Specifying maximum aperture.....	123

Advanced Features — Playback



Using PLAYBACK MENU.....	126
Setting the [PLAYBACK MENU]	126
PLAYBACK MENU.....	127
Erasing the images (ERASE).....	127
DPOF set frame (PRINT ORDER (DPOF)).....	128
Protecting the images (PROTECT).....	132
Setting automatic playback (SLIDE SHOW)	133
Increasing monitor brightness (LCD BRIGHTNESS)	134
Cropping the images (CROPPING)	134

Settings

[SET] SET UP	138
Using the [SET UP] menu	138
List of [SET UP] menu options	139
[SHOOTING]	146
[DISPLAY]	150
[ROTATE IMAGE]	151
[AF]	152
[EXPOSURE].....	154
[FLASH/BKT].....	158
[BUTTON ASSIGNMENT].....	166
[MISC.].....	175

Continued ➔

Contents

 MAINTENANCE.....	176
 TIME・言語/LANG.....	177
 SYSTEM.....	179
FORMAT	179
USB MODE	179
FRAME NO.	180
AUTO POWER SAVE	181
BEEP	181
VIDEO SYSTEM	181
SET-UP RESET	181

Camera Connection

Connecting to a TV	182
Connecting Camera Directly to Printer —	
PictBridge Function	183
Before connecting to a printer.....	183
Connecting to a printer.....	183
Specifying images for printing (PRINT WITH DATE / PRINT WITHOUT DATE)	184
Printing with DPOF setting ( PRINT DPOF)	185

Software Installation

Installation on a Windows PC	188
Installation on a Mac OS X	191
Connecting to a PC	194
Using FinePixViewer.....	198

Appendices

System Expansion Option.....	200
Accessories Guide	202
Using Your Camera Correctly	203

Cleaning the CCD	204
Power Supply and Battery	208
Notes on the Memory Card	211
Warning Displays	212
Warning messages displayed in the control panel and viewfinder	212
Warning messages displayed in the LCD monitor	214

Troubleshooting

Troubleshooting.....	218
----------------------	-----

Specifications	223
Explanation of Terms	228
FUJIFILM Digital Camera Worldwide	
Network.....	230
Safety Notes.....	238

Preface

■ Test Shots Prior to Photography

For important photographs (such as weddings and overseas trips), always take a test shot and view the image to make sure that the camera is working normally.

- FUJIFILM Corporation cannot accept liability for any incidental losses (such as the costs of photography or the loss of income from photography) incurred as a result of faults with this product.

■ Notes on Copyright

Images recorded using your digital camera system cannot be used in ways that infringe copyright laws without the consent of the owner, unless intended only for personal use. Note that some restrictions apply to the photographing of stage performances, entertainments and exhibits, even when intended purely for personal use. Users are also asked to note that the transfer of memory cards (CompactFlash or Microdrive) containing images or data protected under copyright laws is only permissible within the restrictions imposed by those copyright laws.

■ Handling Your Digital Camera

This camera contains precision electronic components. To ensure that images are recorded correctly, do not subject the camera to impact or shock while an image is being recorded.

■ Liquid Crystal

If the LCD monitor is damaged, take particular care with the liquid crystal in the monitor. If any of the following situations arise, take the urgent action indicated.

- If liquid crystal comes in contact with your skin
Wipe the area with a cloth and then wash thoroughly with soap and running water.
- If liquid crystal gets into your eye
Flush the affected eye with clean water for at least 15 minutes and then seek medical assistance.
- If liquid crystal is swallowed
Flush your mouth thoroughly with water. Drink large quantities of water and induce vomiting. Then seek medical assistance.

■ Trademark Information

- CompactFlash is a trademark of SanDisk Corporation.
- IBM PC/AT is a registered trademark of International Business Machines Corp. of the U.S.A.
- Macintosh, Power Macintosh, iMac, PowerBook, iBook and Mac OS are trademarks of Apple Inc., registered in the U.S. and other countries.
- Microsoft, Windows, the Windows logo, Windows Vista and the Windows Vista logo are trademarks or registered trademarks of Microsoft Corporation in the United States and/or other countries. Windows is an abbreviated term referring to the Microsoft® Windows® Operating System.
- * The “Designed for Microsoft® Windows® XP” logo refers to the camera and the driver only.
- Other company or product names are trademarks or registered trademarks of the respective companies.

Continued ➔

■ **Notes on Electrical Interference**

If the camera is to be used in hospitals or aircrafts, please note that this camera may cause interference to other equipment in the hospital or aircraft. For details, please check with the applicable regulations.

■ **Explanation of Color Television System**

NTSC: National Television System Committee, color television telecasting specifications adopted mainly in the U.S.A., Canada and Japan.

PAL: Phase Alternation by Line, a color television system adopted mainly by European countries and China.

■ **Exif Print (Exif ver. 2.2)**

Exif Print Format is a newly revised digital camera file format that contains a variety of shooting information for optimal printing.

* See "Using Your Camera Correctly" (→p.203) for more information.

About this Manual

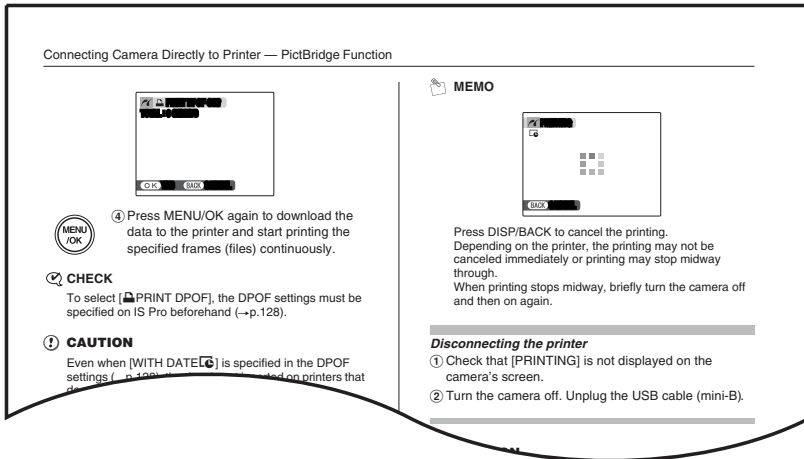

! CAUTION

This mark denotes issues that may affect the camera's operation.

✓ CHECK

This mark denotes points to notice in the camera's operation.

📄 MEMO

This mark denotes additional topics that complement the basic operating procedures.

■ 4-direction (▲▼◀▶) button

Up, down, left, and right are indicated by black triangles in the Owner's Manual. Up or down is shown as ▲ or ▼, and left or right is shown as ◀ or ▶.

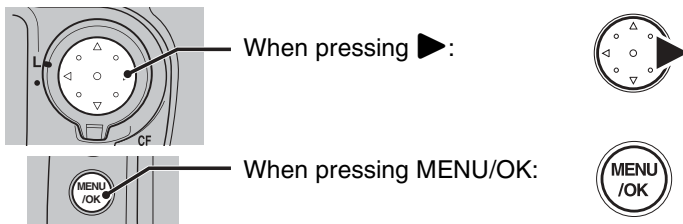

■ Notation

In this manual, "memory card" means CompactFlash memory card (CF card)/Microdrive. Also, the messages displayed in the LCD monitor on the camera or application software appear in square brackets([]).

Accessories Included

- Rechargeable battery NP-150 (1)

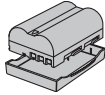

- Battery charger BC-150 (1)

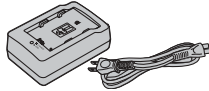

- Shoulder strap (1)



- Eyepiece cap (1)

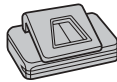

- LCD cover (1)
Fitted on the camera body



- Camera body cap (1)
Fitted on the camera body



- Video cable for IS Pro (1)

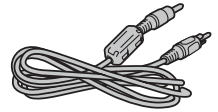

- USB cable (mini-B) (1)

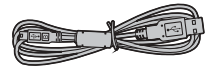

- Accessory shoe cover (1)
Fitted on the camera body
- Synchronizing terminal cap (1)
Fitted on the camera body
- Remote release socket cap (1)
Fitted on the camera body
- CD-ROM (1)
Software for FinePix CX



Camera Parts and Features

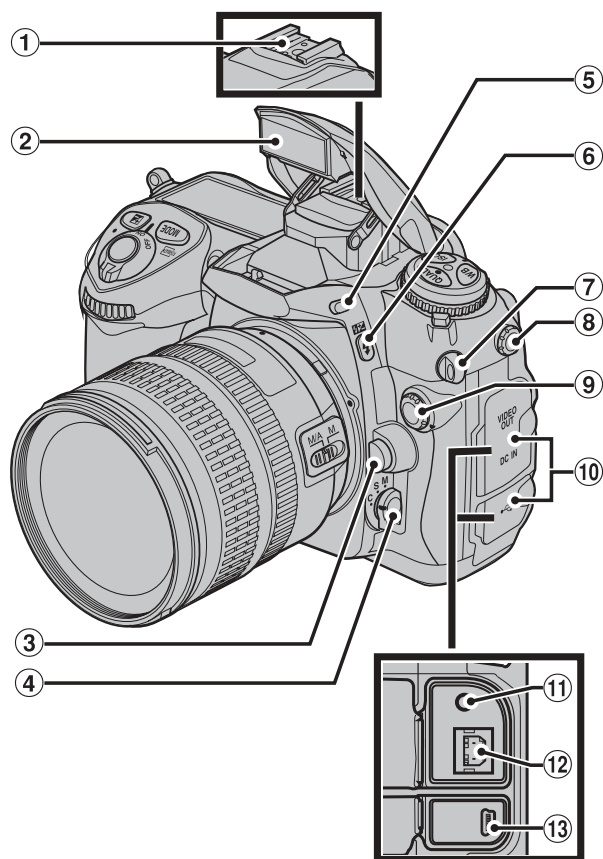

- ① Accessory shoe (p.91)
- ② Built-in flash (p.78)
- ③ Lens release button (p.24)
- ④ Focus-mode selector (p.47, 54)
- ⑤ Flash pop-up button (p.79)
- ⑥ ⚡ Flash sync mode button (p.82) /
⚡ Flash compensation button (p.84)
- ⑦ Strap mount (p.23)
- ⑧ Sync terminal (p.91)
- ⑨ 10-pin remote terminal
- ⑩ Terminal cover (p.182)
- ⑪ VIDEO OUT (Video output) socket (p.182)
- ⑫ DC IN (power input) socket
- ⑬ 🖱️ USB socket (p.183, p.194)

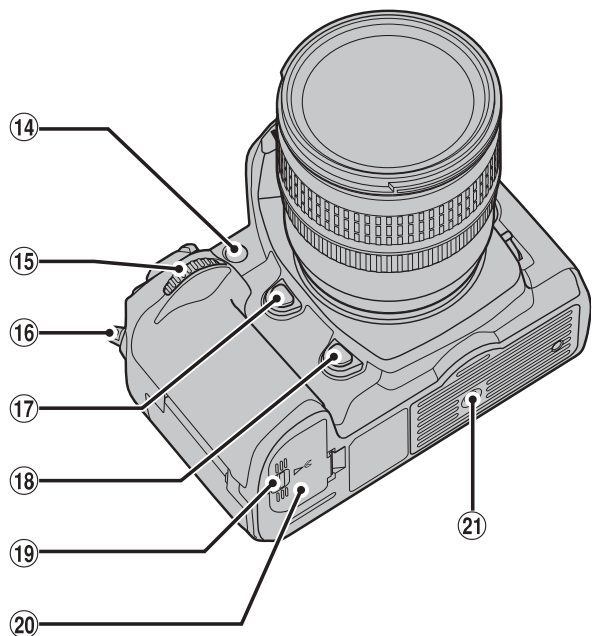

Continued ➡

Camera Parts and Features

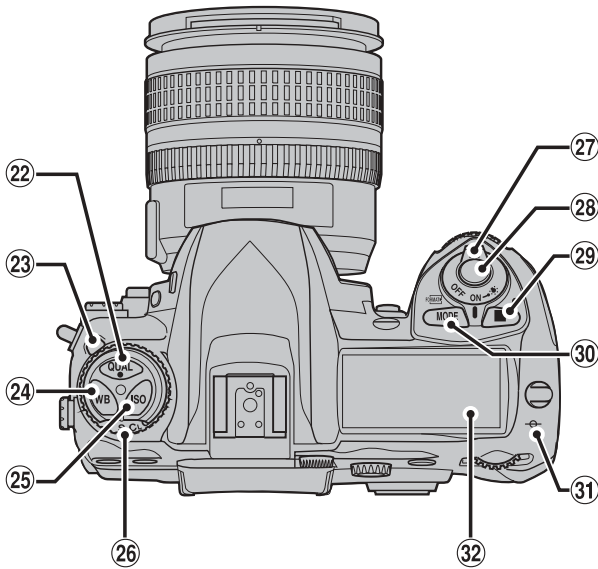

- ⑭ AF-assist illuminator (p.64)/Self-timer lamp (p.101)/
Red-eye reduction lamp (p.82)
- ⑮ Sub-command dial
- ⑯ Strap mount (p.23)
- ⑰ Depth-of-field preview button (p.65)
- ⑱ FUNC. Button (p.168)
- ⑲ Battery cover lock release catch (p.32)
- ⑳ Battery cover (p.32)
- ㉑ Tripod mount



- ② QUAL (image quality/size) button (p.93, 94)/
Reset button (p.120)
- ③ Release mode dial unlock button (p.66)
- ④ WB (white balance) button (p.95-100)
- ⑤ ISO (ISO sensitivity) button (p.92)
- ⑥ Release mode dial (p.66)
- ⑦ Power switch (p.36)/ Illuminator switch (p.18)
- ⑧ Shutter button (p.49)
- ⑨  (Exposure compensation) button (p.76)/
Reset button (p.120)
- ⑩ MODE (exposure mode) button (p.70)/
 Format button (p.35)
- ⑪ Focal plane mark (p.60)
- ⑫ Control panel (p.17)

Continued ➔

Camera Parts and Features

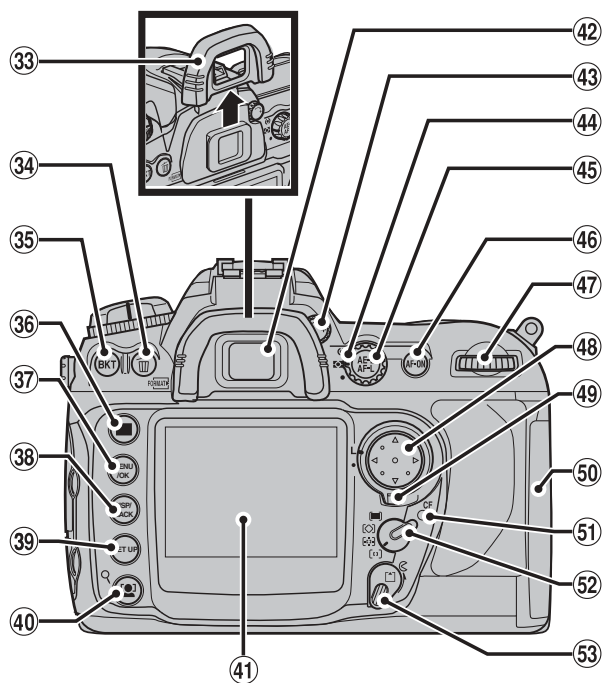

- ③③ Viewfinder eyepiece cup (p.102)
- ③④ (erase) button (p.53)/ Format button (p.35)
- ③⑤ BKT (bracketing) button (p.103)
- ③⑥ (playback) button (p.50)
- ③⑦ MENU/OK button
- ③⑧ DISP (display)/BACK button (p.50)
- ③⑨ SET UP button (p.138)
- ④① Face zoom in button (p.52)/Help button (p.108)
- ④① LCD monitor (p.29, 134, 203)
- ④② Viewfinder (p.40)
- ④③ Diopter adjustment control (p.40)
- ④④ Metering selector (p.68)
- ④⑤ AE-L/AF-L (AE / AF lock) button (p.62, p.69)
- ④⑥ AF-ON button (p.55)
- ④⑦ Main-command dial
- ④⑧ Multi-selector
- ④⑨ Focus selector lock (p.59)
- ⑤① Slot cover (p.34)
- ⑤① Access lamp (p.34)
- ⑤② AF-area mode selector (p.55)
- ⑤③ Card slot cover latch (p.34)

Example of Control Panel, Viewfinder and LCD Monitor

Control panel

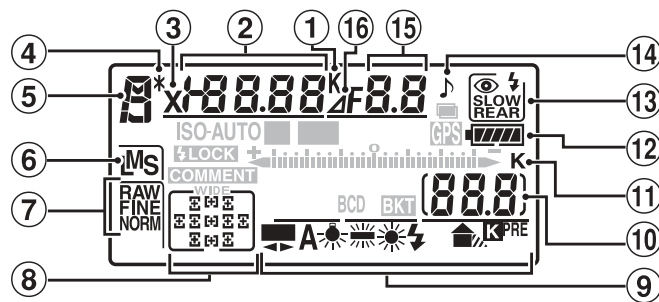

- ① Color temperature indicator (p.97)
- ② Shutter speed (p.70-p.76)
Exposure compensation value (p.76)
Flash compensation value (p.84)
ISO sensitivity (p.92)
Color temperature, or preset number (p.97, 99)
Number of shots in bracketing sequence (p.103)
Focal length (non-CPU lens) (p.123)
- ③ Flash sync indicator (p.158)
- ④ Flexible program indicator (p.71)
- ⑤ Exposure mode (p.70)
- ⑥ Image size (p.94)
- ⑦ Image quality (p.93)
- ⑧ Focus area (p.59)
AF-area mode (p.56)
- ⑨ White balance mode (p.95)
- ⑩ Number of available frames (p.49)
Number of shots remaining before memory buffer fills (p.67)
PC mode indicator
Preset white balance recording indicator (p.100)
- ⑪ "K" (appears when memory remains for over 1000 exposures) (p.21)
- ⑫ Battery level indicator (p.33)
- ⑬ Flash sync mode (p.82)
- ⑭ "Beep" indicator (p.181)
- ⑮ Aperture (f/-number) (p.70-76)
Aperture (number of stops) (p.73, 76)
Bracketing increment (p.103)
Maximum aperture (non-CPU lens) (p.124)
PC connection indicator (p.195)
- ⑯ Aperture stop indicator (p.73, 76)

Continued ➔

Example of Control Panel, Viewfinder and LCD Monitor

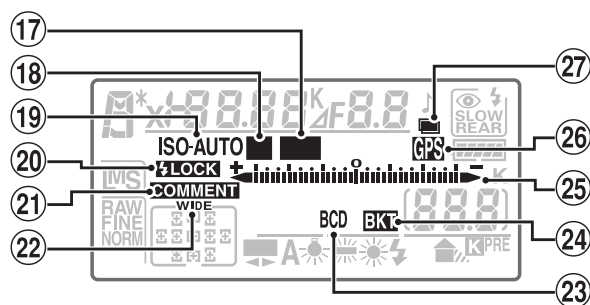

- ⑰ Flash compensation indicator (p.84)
- ⑱ Exposure compensation indicator (p.76)
- ⑲ ISO sensitivity indicator (p.92)
ISO auto control indicator (p.156)
- ⑳ Flash value (FV) lock (p.85)
- ㉑ Image comment indicator (p.146)
- ㉒ Wide-frame focus area indicator (p.58)
- ㉓ Barcode data input display (p.147)

- ㉔ Bracketing indicator (p.103)
- ㉕ Electronic analog exposure display (p.75)
Exposure compensation (p.76)
Bracketing progress indicator (p.103)
PC connection indicator (p.195)
- ㉖ GPS connection indicator (p.147)
- ㉗ Multiple exposure indicator (p.116)

■ The LCD Illuminator

Holding the power switch in the  position activates the control panel backlight (LCD illuminator), allowing the display to be read in the dark. After the power switch is released, the illuminator will remain active except immediately after the shutter is released, or when the auto power save is activated.

Viewfinder

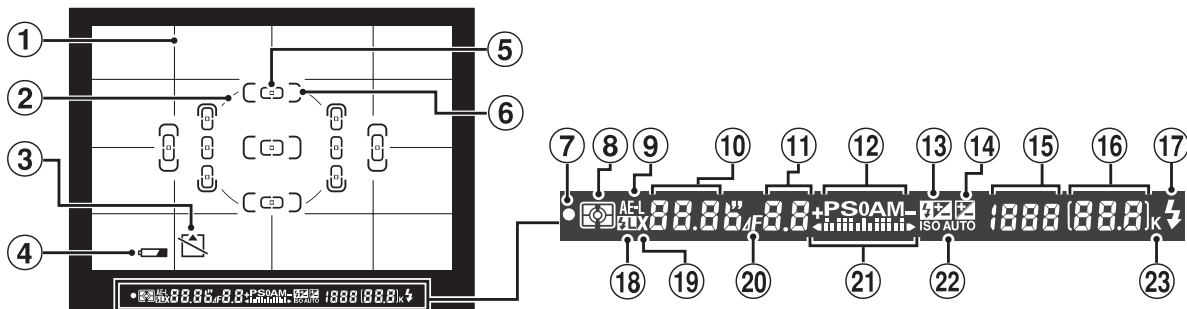

- ① Framing grid
(Displayed when [ON] is selected for the [GRID DISPLAY] under [DISPLAY] in the [SET UP] menu.) (p.22)
- ② 8-mm (0.31-in.) reference circle for center-weighted metering (p.68)
- ③ “No memory card” warning* (p.213)
- ④ Battery indicator* (p.33)
- ⑤ Normal-frame focus brackets (focus areas) (p.57)
- ⑥ Wide-frame focus brackets (focus areas) (p.57)
- ⑦ Focus indicator (p.48, 54)
- ⑧ Metering (p.68)
- ⑨ Autoexposure (AE) lock (p.69)
- ⑩ Shutter speed (p.70-76)
- ⑪ Aperture (f/-number) (p.70-76)
Aperture (number of stops) (p.73, 76)
- ⑫ Exposure mode (p.70)
- ⑬ Flash compensation indicator (p.84)
- ⑭ Exposure compensation indicator (p.76)
- ⑮ ISO sensitivity (p.92)
- ⑯ Number of available frames (p.49)
Number of shots available before memory buffer fills (p.67)
- ⑰ Preset white balance recording indicator (p.100)
- ⑱ Exposure compensation value (p.76)
- ⑲ Flash compensation value (p.84)
- ⑳ PC connection indicator (p.195)
- ㉑ Flash-ready indicator (p.79)
- ㉒ Flash value (FV) lock (p.85)
- ㉓ Flash sync indicator (p.158)
- ㉔ Aperture stop indicator (p.73, 76)
- ㉕ Electronic analog exposure display (p.75)
Exposure compensation (p.76)
- ㉖ ISO auto control indicator (p.156)
- ㉗ “K” (appears when memory remains for over 1000 exposures) (p.21)

* To not display, use the [VIEWFINDER WARNING] under [DISPLAY] in the [SET UP] menu.

Continued ➔

LCD Monitor

Photo information 1

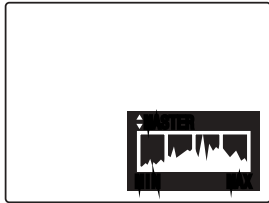

Highlights can be displayed separately for each of the following: histogram for brightness (all channels), red, green, and blue color channels, and brightness warning.

CAUTION

Brightness warning



Overexposed area blinks in black.

Brightness warning

Photo information 2

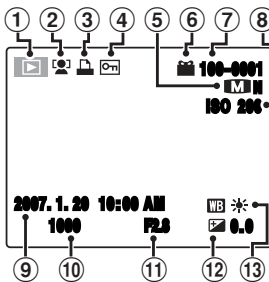

- ① Playback mode (p.50)
- ② Zoom in face (p.52)
- ③ DPOF (p.130)
- ④ Protection (p.132)
- ⑤ Quality mode (p.93)
- ⑥ Present (p.50)
- ⑦ Frame number (p.180)
- ⑧ Sensitivity (p.92)
- ⑨ Date and time (p.36)
- ⑩ Shutter speed (p.72)
- ⑪ Aperture (p.73)
- ⑫ Exposure compensation (p.76)
- ⑬ White balance (p.95)

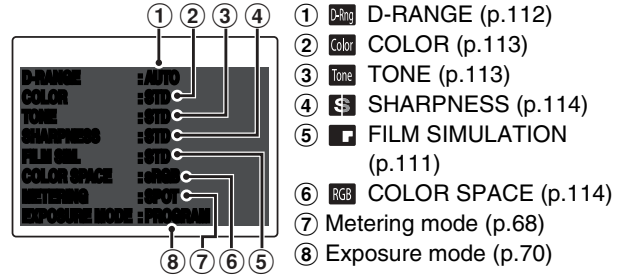

- ① D-RANGE (p.112)
- ② COLOR (p.113)
- ③ TONE (p.113)
- ④ SHARPNESS (p.114)
- ⑤ FILM SIMULATION (p.111)
- ⑥ COLOR SPACE (p.114)
- ⑦ Metering mode (p.68)
- ⑧ Exposure mode (p.70)

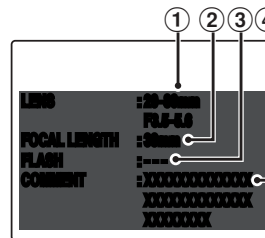

- ① Lens
- ② Focal length
- ③ Flash sync mode (p.82)
- ④ IMAGE COMMENT (p.146)

MEMO

- While playing back images on the LCD monitor or when in single-frame playback mode, press DISP/BACK to switch the display. When the screen display is histogram (or photo information), press ▲▼ to switch color channels (or to display different information).
- When the screen display is photo information 2, press ▲▼ several times to display the focus frame.

■ Large-capacity memory cards

When enough memory remains on the memory card to record a thousand or more pictures at current settings, the number of available frame will be shown in thousands, round down to the nearest hundred (e.g., if there is room for approximately 1,260 exposures, the exposure count display will show 1.2K).

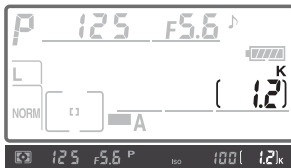

■ Camera off display

If the camera is turned off with a battery and memory card inserted, the number of available frame will be displayed in the control panel.



! CAUTION

- When the battery is totally exhausted, the display in the viewfinder will dim. The viewfinder display will return to normal when a fully-charged battery is inserted.
- The LCD panel in the upper part of the viewfinder (focus area and grid lines) will become paler at high temperatures and will become darker and respond a little more slowly at low temperatures. However, it will operate normally again at normal temperatures.
- The LCD panel in the viewfinder display (where the icons and numbers are displayed) will turn dark at high temperatures and will respond a little more slowly at low temperatures. However, it will operate normally again at normal temperatures.

Continued ➔

About advanced focusing screen display

The new advanced focusing screen display of the IS Pro employs the convenient Vari-Brite focus area display system; it enables clear display of the focus brackets at the selected focus area in the viewfinder for easy identification. When the finder image is bright, the focus brackets are displayed in black and when the finder image is dark, the focus brackets are momentarily illuminated in red. The selected focus area can be identified easily in both bright and dark conditions with this function. Also, the new Advanced Focusing Screen Display allows the superimposition of grid lines. The grid lines can be displayed by selecting [ON] for the [GRID DISPLAY] under [DISPLAY] in the [SET UP] menu (→p.150). These grids assist you in composing the frame, in taking landscape pictures or in shifting/tilting PC-Nikkor lenses.

* Due to characteristics of the LCD used in the Vari-Brite focus area display system, a thin line outside the selected focus area may also be displayed or the entire viewfinder may be illuminated in red under certain conditions. These are not malfunctions.

Attaching the Strap and Lens

Attaching the strap

Attach the strap to the strap mounts on the camera. Once you have attached both ends of the strap, check carefully to make sure that the strap is firmly secured.

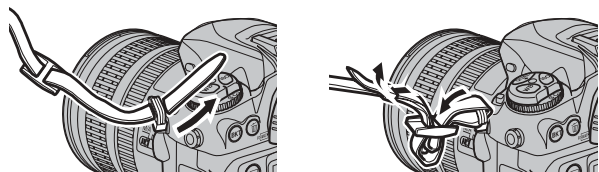

CAUTION

Attach the strap correctly to prevent dropping the camera.

Mounting the camera lens

1 Check the lens type.

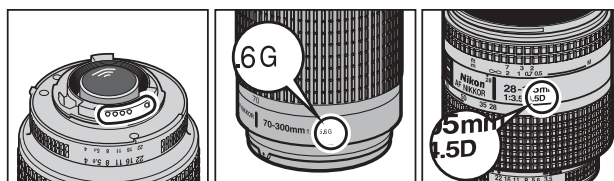

CPU contacts of CPU lens
The lens is fitted with CPU signal contacts.

G-type Nikkor lens
(without aperture ring)

CPU Nikkor lens other than G-type
(with aperture ring)

MEMO

See "Lens compatibility" (→p.25) for details.

2 Set the Power switch to OFF to turn the camera off (→p.36).

3 Remove the rear lens cap and camera body cap.

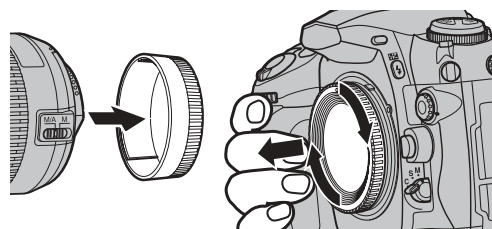

Continued ➔

- 4** Position the lens in the camera's bayonet mount so that the mounting indexes on lens and camera body are aligned, then twist lens counterclockwise until it locks into place.

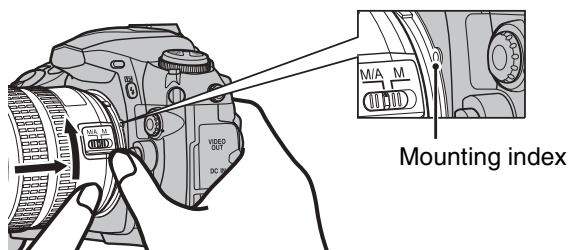

⚠ CAUTION

- Always change the lens in an area free of dirt and dust.
- When attaching the lens, take care not to press the lens release button.
- Take care not to mount the lens when it is at an angle to the camera as this can damage the lens mount on the camera.

Detaching lenses

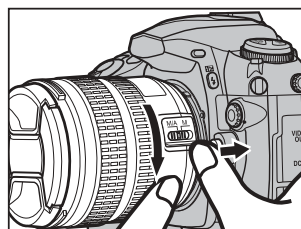



Be sure the camera is off when removing or exchanging lenses. To remove the lens, press and hold the lens release button while turning the lens clockwise. While the lens is removed from the camera, fit the camera body cap provided onto the camera to protect the inside of the camera and prevent soiling of the mirror and viewfinder screen. You can also use the Nikon Body Cap.

■ Lens compatibility

Use a CPU lens (except IX-Nikkor) with this camera. D- or G-type AF lenses give you access to all available functions.

Types of CPU lenses and other usable lenses/accessories

Lens/accessory		Camera setting		Focus mode			Exposure mode		Metering		
		AF	M (with electronic range finder)	M	P S	A M			 		
							3D	Color			
CPU lenses*1	Type G or D AF Nikkor *2; AF-S, AF-I Nikkor	✓	✓	✓	✓	✓	✓	–	✓*3		
	PC-Micro Nikkor 85 mm f/2.8D *4	–	✓*5	✓	–	✓*6	✓	–	✓*3		
	AF-S / AF-I Teleconverter *7	✓*8	✓*8	✓	✓	✓	✓	–	✓*3		
	Other AF Nikkor (except lenses for F3AF)	✓*9	✓*9	✓	✓	✓	–	✓	✓*3		
	AI-P Nikkor	–	✓*10	✓	✓	✓	–	✓	✓*3		
Non-CPU lenses*11	AI-modified, Ai, Ai-S, or Series E Nikkor *12	–	✓*10	✓	–	✓*13	–	✓*14	✓*15		
	Medical Nikkor 120 mm f/4	–	✓	✓	–	✓*16	–	–	–		
	Reflex Nikkor	–	–	✓	–	✓*13	–	–	✓*15		
	PC-Nikkor	–	✓*5	✓	–	✓*17	–	–	✓		
	AI-type Teleconverter *18	–	✓*8	✓	–	✓*13	–	✓*14	✓*15		
	TC-16AS AF Teleconverter	–	✓*8	✓	–	✓*13	–	✓*14	✓*15		
	PB-6 Bellows Focusing Attachment *19	–	✓*8	✓	–	✓*20	–	–	✓		
Auto extension rings (PK-series 11-A, 12, or 13; PN-11)	–	✓*8	✓	–	✓*13	–	–	✓			

*1 IX Nikkor lenses cannot be used.

*2 Vibration Reduction (VR) supported with VR lenses.

*3 Spot metering meters selected focus area.

*4 The camera's exposure metering and flash control systems do not work properly when shifting and/or tilting the lens, or when an aperture other than the maximum aperture is used.

*5 Electronic range finder cannot be used with shifting or tilting.

Continued ➔

Attaching the Strap and Lens

- *6 Manual exposure mode only.
 - *7 Compatible with AF-I Nikkor lenses and with all AF-S lens except AF-S DX VR ED 18-200 mm f/3.5-5.6G; AF-S DX ED 12-24 mm f/4G, 17-55 mm f/2.8G, 18-55 mm f/3.5-5.6G, 18-70 mm f/3.5-4.5G, and 55-200 mm f/4-5.6G; AF-S VR ED 24-120 mm f/3.5-5.6G; and AF-S ED 17-35 mm f/2.8D, 24-85 mm f/3.5-4.5G, and 28-70 mm f/2.8D.
 - *8 With maximum effective aperture of f/5.6 or faster.
 - *9 If AF 80-200 mm f/2.8S, AF 35-70 mm f/2.8S, new-model AF 28-85 mm f/3.5-4.5S, or AF 28-85 mm f/3.5-4.5S is zoomed in while focusing at minimum range, image on matte screen in viewfinder may not be in focus when in-focus indicator is displayed. Focus manually using image in viewfinder as guide.
 - *10 With maximum aperture of f/5.6 or faster.
 - *11 Some lenses cannot be used (see following page).
 - *12 Range of rotation for Ai 80-200 mm f/2.8S ED tripod mount limited by camera body. Filters cannot be exchanged while Ai 200-400 mm f/4S ED is mounted on camera.
 - *13 If maximum aperture is specified using [NON-CPU LENS DATA] under [MISC.] in the [SET UP] menu, aperture value will be displayed in viewfinder and control panel.
 - *14 Can be used only if lens focal length and maximum aperture are specified using [NON-CPU LENS DATA] under [MISC.] in the [SET UP] menu. Use spot or center-weighted metering if desired results are not achieved.
 - *15 For improved precision, specify lens focal length and maximum aperture using [NON-CPU LENS DATA] under [MISC.] in the [SET UP] menu.
 - *16 Can be used in manual exposure modes at shutter speeds slower than 1/125 s. If maximum aperture is specified using [NON-CPU LENS DATA] under [MISC.] in the [SET UP] menu, aperture value will be displayed in the viewfinder and control panel.
 - *17 Exposure determined by presetting lens aperture. In aperture-priority auto exposure mode, preset aperture using lens aperture ring before performing AE lock or shifting lens. In manual exposure mode, preset aperture using lens aperture ring and determine exposure before shifting lens.
 - *18 Exposure compensation required when used with Ai 28-85 mm f/3.5-4.5S, Ai 35-105 mm f/3.5-4.5S, Ai 35-135 mm f/3.5-4.5S, or AF-S 80-200 mm f/2.8D. See teleconverter manual for details.
 - *19 Requires PK-12 or PK-13 auto extension ring.
 - *20 Use preset aperture. In exposure mode A, set aperture using focusing attachment before determining exposure and taking photograph.
- PF-4 Reprocopy Outfit requires PA-4 Camera Holder.

■ G-type Nikkor and other CPU Nikkor lens

The G-type Nikkor lens has no aperture ring; aperture should be selected from camera body. Unlike other CPU Nikkor lenses, aperture does not need to be set to minimum (largest f-number).

CPU Nikkor lenses other than G-type Nikkor lens have an aperture ring. Set the lens aperture to its minimum and lock. When the lens is not set to its minimum aperture setting and the power switch is turned on, “fE E” blinks in the control panel and viewfinder and the shutter cannot be released.

■ When a non-CPU lens is attached

If lens data are specified using the [NON-CPU LENS DATA] under [MISC.] in the [SET UP] menu, many of the features available with CPU lenses can also be used with non-CPU lenses. If lens data are not specified, color matrix metering cannot be used, and center-weighted metering is used when matrix metering is selected.

Non-CPU lenses can only be used in exposure modes **A** and **M**, when aperture must be set using the lens aperture ring. If the maximum aperture has not been specified using [NON-CPU LENS DATA], the camera aperture display will show the number of stops from maximum aperture; the actual aperture value must be read off the lens aperture ring. Aperture-priority auto will be selected automatically in exposure modes **P** and **S**. The exposure-mode indicator in the control panel will blink, and **A** will be displayed in the viewfinder.

Continued ➔

■ **Nikkor lenses/accessories that cannot be attached to the IS Pro**

The following Nikkor lenses/accessories cannot be attached to the IS Pro (otherwise camera body or lens may be damaged):

- Non-AI lenses
- Lenses that require the AU-1 focusing unit (400 mm f/4.5, 600 mm f/5.6, 800 mm f/8, 1200 mm f/11)
- Fisheye (6 mm f/5.6, 8 mm f/8, OP 10 mm f/5.6)
- 21 mm f/4 (old type)
- K2 rings
- ED 180-600 mm f/8 (serial numbers 174041-174180)
- ED 360-1200 mm f/11 (serial numbers 174031-174127)
- 200-600 mm f/9.5 (serial numbers 280001-300490)
- Lenses for the F3AF (80 mm f/2.8, 200 mm f/3.5, TC-16 Teleconverter)
- PC 28 mm f/4 (serial number 180900 or earlier)
- PC 35 mm f/2.8 (serial numbers 851001-906200)
- PC 35 mm f/3.5 (old type)
- 1000 mm f/6.3 Reflex (old type)
- 1000 mm f/11 Reflex (serial numbers 142361-143000)
- 2000 mm f/11 Reflex (serial numbers 200111-200310)

Attaching the LCD cover

To prevent soiling or damage to the LCD monitor, attach the enclosed LCD cover to the camera when you are carrying or not using the camera.

- 1 To attach the cover, insert the projection on the top of the cover into the matching indentation above the camera monitor.**

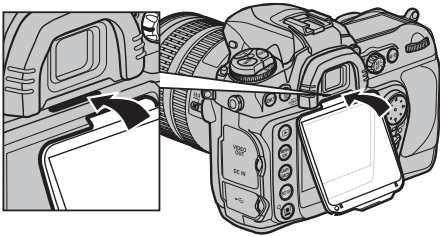

- 2 Press the bottom of the cover until it clicks into place.**

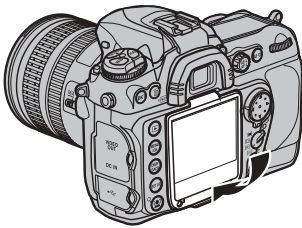

Removing the LCD cover

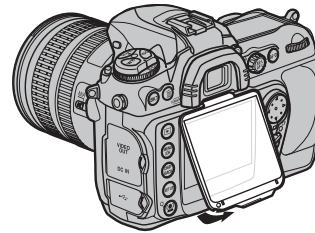

Hold the camera firmly and pull the bottom of the cover gently outwards as shown above.

Charging the Battery

The battery is not fully charged at shipment and must be fully charged before being used.

■ Compatible battery

Rechargeable Battery NP-150

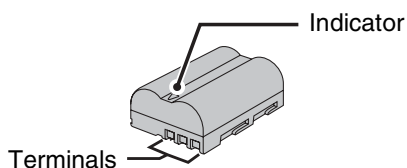

■ Rechargeable battery NP-150

The NP-150 shares information with compatible devices, enabling the battery charge state to be shown in six levels in control panel and as a percentage displayed in [BATTERY INFO] under [MAINTENANCE] in the [SET UP] menu (→p.176), together with battery life and the number of pictures taken since the battery was last charged.

! CAUTION

- **Always use the rechargeable battery NP-150 (included). Other brands of rechargeable battery (including Nikon) cannot be used.**
- The battery is not fully charged at shipment and must be fully charged before being used.
- Connecting the camera directly to the AC power adapter will NOT charge the battery. Use the designated battery charger (BC-150) to charge the battery.
- If the terminals of battery are soiled, it may not be possible to charge it. Clean the battery terminals and battery charger terminals with a clean, dry cloth.
- Charging times increase at low temperatures.
- The NP-150 gradually loses its charge even when not used. Charge a NP-150 just before taking pictures (in the last day or two).
- Do not split or peel outer labels of the battery.
- See p.208-209 for information on the battery.

1 Plug the battery charger BC-150 (included) into the power outlet using the connection cord.

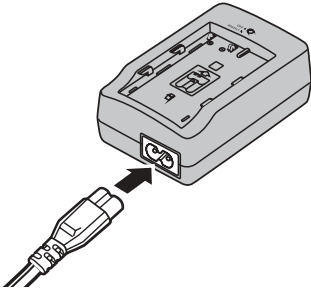

2 Load the battery into the battery charger BC-150 correctly as indicated by the polarity icon to start charging.

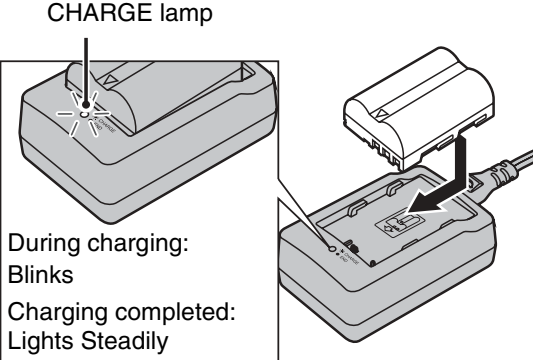

! CAUTION
Unplug the battery charger from the power outlet when it is not in use.

MEMO
Charging a used up battery requires approx. 2 hours and 15 min.

Loading the Battery

- 1** Set the power switch to OFF to turn the camera off (→p.36).
- 2** Open the battery cover.

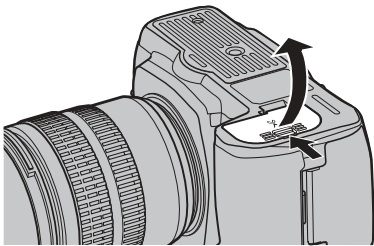

⚠ CAUTION

Do not apply excessive force to the battery cover.

- 3** Load the battery as shown below.

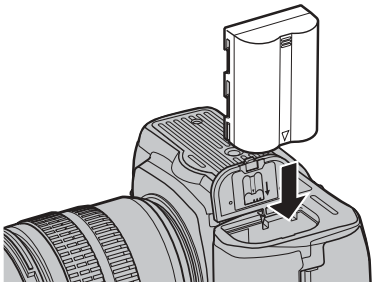

- 4** Close the battery cover.

Removing the battery

Turn the camera off before removing the battery. Replace the terminal cover when the battery is not in use.

Checking the battery charge

Check the battery level in the viewfinder or control panel.

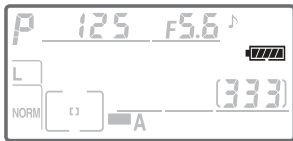

Control panel	Viewfinder	Description
	–	Battery fully charged.
	–	Battery partially discharged.
		Low battery. Ready fully-charged spare battery.
 (blinks)	 (blinks)	Shutter-release disabled. Change battery.

! CAUTION

- Due to the nature of the battery, the battery level indicator (,) may appear early when the camera is used in cold locations. Try warming the battery in your pocket or a similar location before use.
- Depending on the camera mode, the transition from to may occur more quickly.
- See p.208-209 for information on the battery.

Inserting Memory Cards

Photographs are stored on CompactFlash/Microdrive (available separately).

In this manual, "Memory card" means CompactFlash memory card (CF card)/Microdrive.

Available CompactFlash/Microdrive

The following cards have been tested and approved for use with the IS Pro:

- SanDisk

SDCFH (Ultra II)	512MB, 1GB, 2GB, 4GB
SDCFH (Extreme III)	1GB, 2GB, 4GB

- Microdrive 1GB, 2GB, 4GB, 6GB

CAUTION

Operation is not guaranteed with other makes of card. For more details on the above cards, please contact the manufacturer.

1 Set the power switch to OFF to turn the camera off (→p.36).

Check the access lamp is off.

2 Turn the card slot cover latch to open the slot cover.

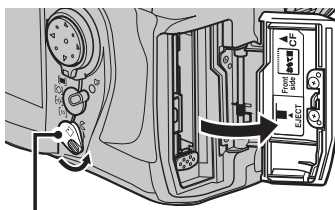

Card slot cover latch

CAUTION

Never open the slot cover while the camera is on. This could destroy the image data or damage the memory card itself.

3 Insert the card as shown below.

The access lamp will light for about a second.

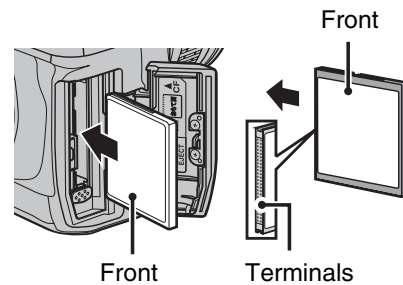

CAUTION

Confirm that the memory card is in the orientation shown. Attempting to insert cards upside down or backward could damage the camera or card. Do not use excessive force.

4 Close the slot cover.

Removing memory cards

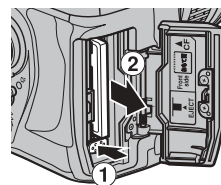



Open the slot cover, press the eject button and remove the memory card.

Formatting the memory card

Formatting memory cards permanently deletes all photographs and other data they may contain. Be sure all data you wish to keep has been copied to another storage device before formatting the card.

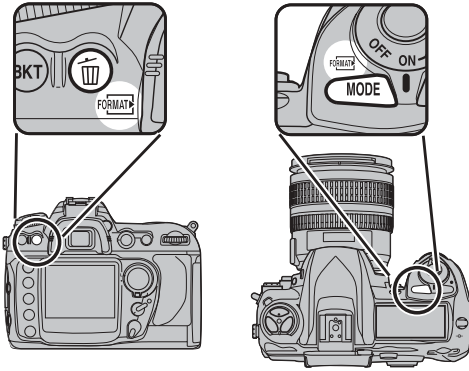
- Turn the camera on (→p.36).
- Press  and MODE simultaneously for about 2 seconds.
F o r blinks in the control panel and viewfinder.



- Press  and MODE again.



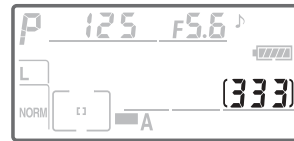

- After formatting is completed, the control panel shows the number of available frames.



CAUTION

Do not turn the camera off or remove the battery or memory card until formatting is completed.

MEMO

- When *F o r* blinks, press any other button except for  and MODE to exit without formatting memory card.
- Formatting can be performed using [FORMAT] under  SYSTEM] in the [SET UP] menu.

Turning On and Off

Set the power switch to ON to turn the camera on.
Set the power switch to OFF to turn the camera off.

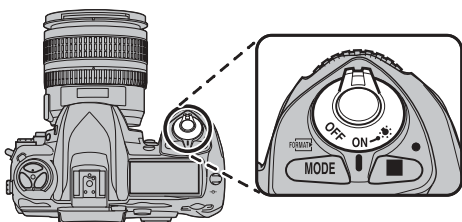

Setting the language, date, and time

When using the camera for the first time after purchasing, the language, date, and time are cleared. [START MENU] screen appears, then set the language, date, and time.

1 [言語/LANG.] screen appears when turning the camera on.



① Press ▲, ▼, ◀, or ▶ to select the language.



② Press MENU/OK to confirm the setting.

2 Set the date and time.

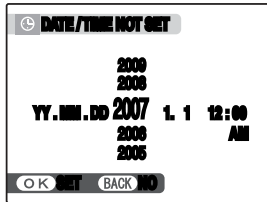

① Press ◀ or ▶ to select Year, Month, Day, Hour, or Minute.



② Press ▲ or ▼ to correct the setting.

MEMO

- Holding down ▲ or ▼ changes the numbers continuously.
- When the time displayed passes “12”, the AM/PM setting changes.

3 Change the date format.

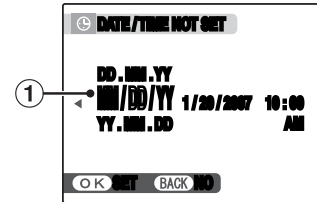

① Press ◀ or ▶ to select the date format.



② Press ▲ or ▼ to set the format.



③ Always press MENU/OK after the settings are completed.

Date format

ex. January 20, 2007
 YY.MM.DD: 2007.1.20
 MM/DD/YY: 1/20/2007
 DD.MM.YY: 20.1.2007

Continued ➔



MEMO

[START MENU] screen also appears when the battery have been removed and the camera has been left for a long period. Once the AC power adapter has been connected or the battery has been installed for 2 days or more, the camera settings will be retained for roughly 6 months even if both sources of power are removed.

Auto power save function

When the auto power save function is active, if the camera is left unused for the preset time, the camera goes to standby status (→p.181). The viewfinder display, the aperture and shutter speed indicators in the control panel will turn off in standby status. To return to ready status, press the shutter button halfway or press .

Correcting the Date and Time

1 Open the [SET UP] menu.

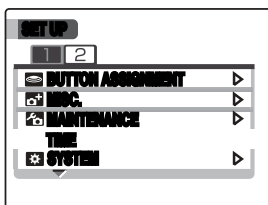

① Press SET UP to open the [SET UP] menu.



② Press ▲ or ▼ to select [TIME] · 言語/LANG.].



③ Press ►.

2 Display the [DATE/TIME] screen.

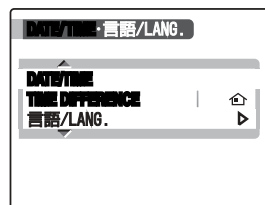

① Press ▲ or ▼ to select [DATE/TIME].



② Press ►.
See “2 Set the date and time.” (→p.37).

Adjusting Viewfinder Focus

Photographs are framed in the viewfinder. Before shooting, make sure that the display in the viewfinder is in clear focus.

Remove the front lens cap and rotate the diopter adjustment control until the focus brackets are displayed in sharp focus when the shutter button is pressed halfway.

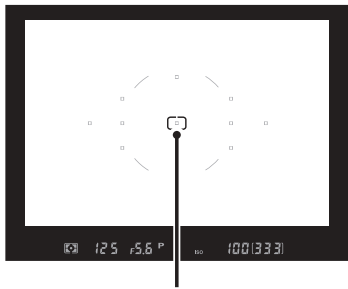
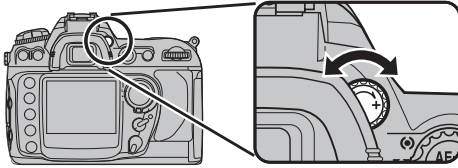

Focus brackets

⚠ CAUTION

When operating the diopter adjustment control with your eye to the viewfinder, be careful not to put your fingers or fingernails in your eye.

Selecting the Language

1 Open the [SET UP] menu.

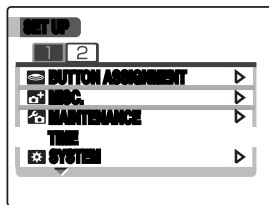

① Press SET UP to open the [SET UP] menu.



② Press ▲ or ▼ to select [TIME
・言語/LANG.].



③ Press ►.

2 Display the [言語/LANG.] screen.

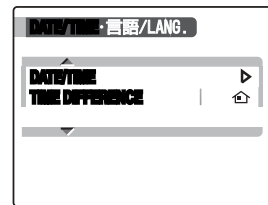

① Press ▲ or ▼ to select [言語/LANG.].



② Press ►.

See “1 [言語/LANG.] screen appears when turning the camera on.” (→p.36).

Basic Operation Guide

This section describes the camera's buttons and functions.

Shutter button (p.49)

Press this button halfway to restore the camera to shooting mode. Press down fully to take a picture.

Power switch (p.36)/Illuminator switch (p.18)

Turns the camera on and off. Illuminates the control panel.

Accessory shoe (p.91)

Mount an external flash here.

Flash pop-up button (p.79)

To use the built-in flash, press this button to pop-up the flash.

Sync terminal (p.91)

Use this to connect flash units that require a sync cable.

Focus-mode selector (p.47, 54)

Selects AF-S (Single-AF servo), AF-C (Continuous-AF servo) or M (Manual) as the focus mode.

⚡ Flash sync mode button (p.82)

Used with the main-command dial to select synchro mode.

⚡ Flash compensation button (p.84)

Used with the sub-command dial to select the flash exposure compensation value.

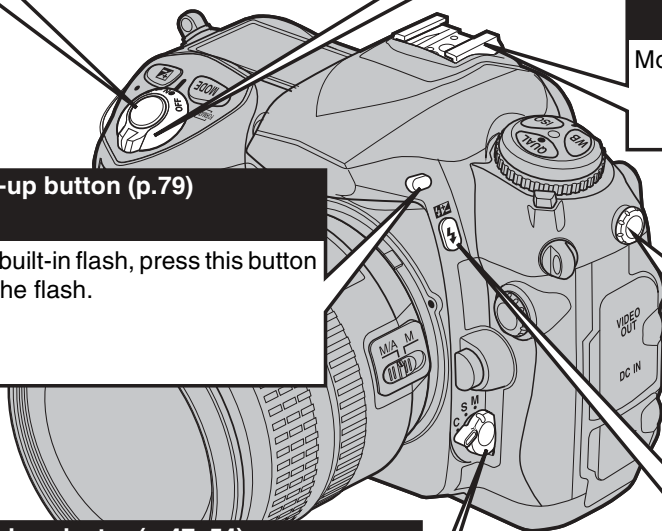

Release mode dial unlock button (p.66)
 Hold down this button to move the release mode dial.

Release mode dial (p.66)
 Selects **S** (Single-frame), **CL** (Low speed continuous), **CH** (High speed continuous), **☺** (Self-timer), or **MUP** (Mirror up) as the shutter release mode.

QUAL (image quality/size) button (p.93, 94)
 Selects the quality and size of an image when the image is recorded.

ISO (ISO sensitivity) button (p.92)
 Used with the main-command dial to select ISO setting.

WB (white balance) button (p.96, 97, 100)
 Used with the main-command dial to select white balance setting.

MODE (Exposure mode) button (p.70)
 Used with the main-command dial to select exposure mode.
P: Programmed Auto
S: Shutter-priority Auto
A: Aperture-priority Auto
M: Manual

☑ (Exposure compensation) button (p.76)
 Used with the main-command dial to select the exposure compensation value.

FORMAT **Format button (p.35)**
 Used to format the memory card inserted in the camera. Used simultaneously with Erase (Format) button.

Control panel (p.17)
 Displays the information shown in the viewfinder along with other information.

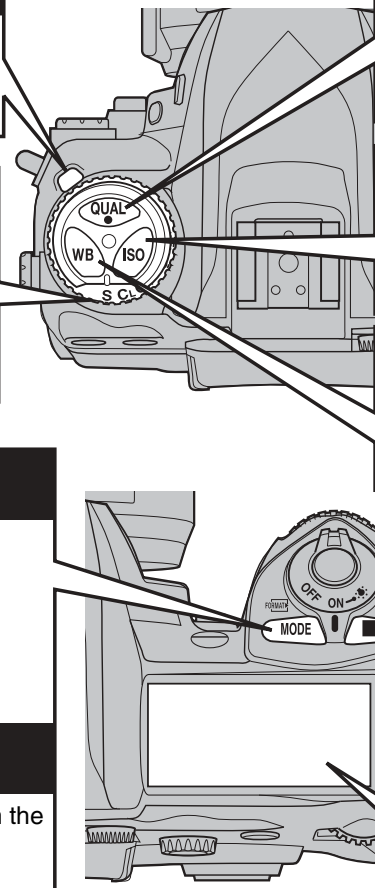

Continued ➔

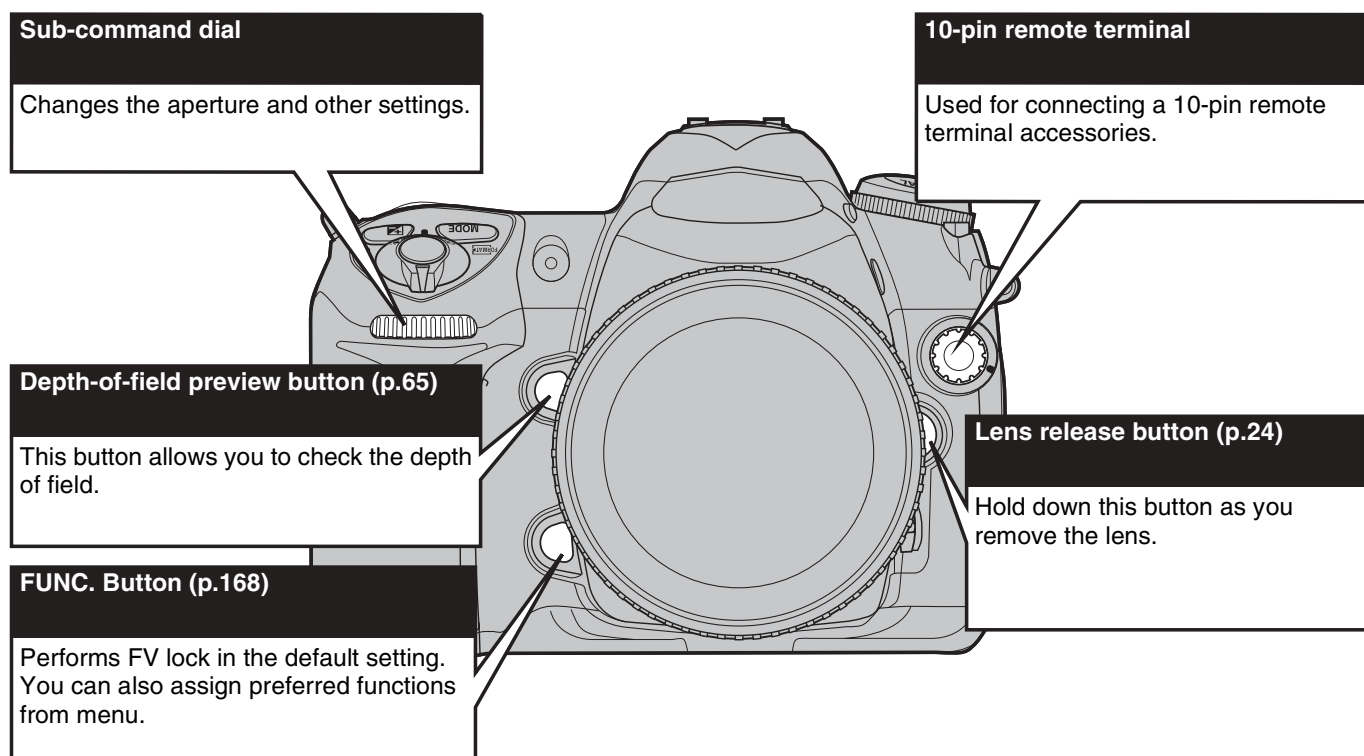

BKT (bracketing) button (p.103)

Used with the command dials to select auto exposure bracketing. Select the types of auto bracketing from the [SET UP] menu before making the settings using the button and dial.
 Main-command dial: Sets the number of images to be shot.
 Sub-command dial: Sets compensation value.

(erase) button (p.53)

Used to delete an image while the image is played back.

Format button (p.35)

Formats the media inserted in the camera. Used simultaneously with the MODE (format) button.

(playback) button (p.50)

Switches playback display on and off.

MENU/OK button

Press this button to display the [SHOOTING MENU] or [PLAYBACK MENU], or to confirm an action in the menu screen. See p.109 for the [SHOOTING MENU] list.

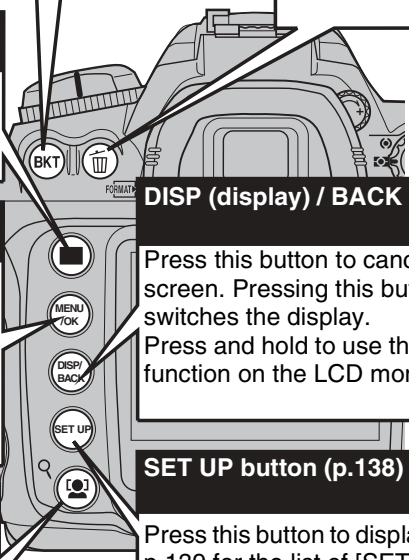

DISP (display) / BACK button (p.50)

Press this button to cancel an action in the menu screen. Pressing this button in playback mode switches the display.
 Press and hold to use the 'black and white live view' function on the LCD monitor.

Face zoom in button (p.52) / Help button (p.108)

Used to zoom (enlarge) in on a face while the image is played back, and to display the help screen while using menus.
 Press and hold to use the function for 'live' view on the LCD monitor.

SET UP button (p.138)

Press this button to display the [SET UP] screen. See p.139 for the list of [SET UP] menu options.

Continued ➔

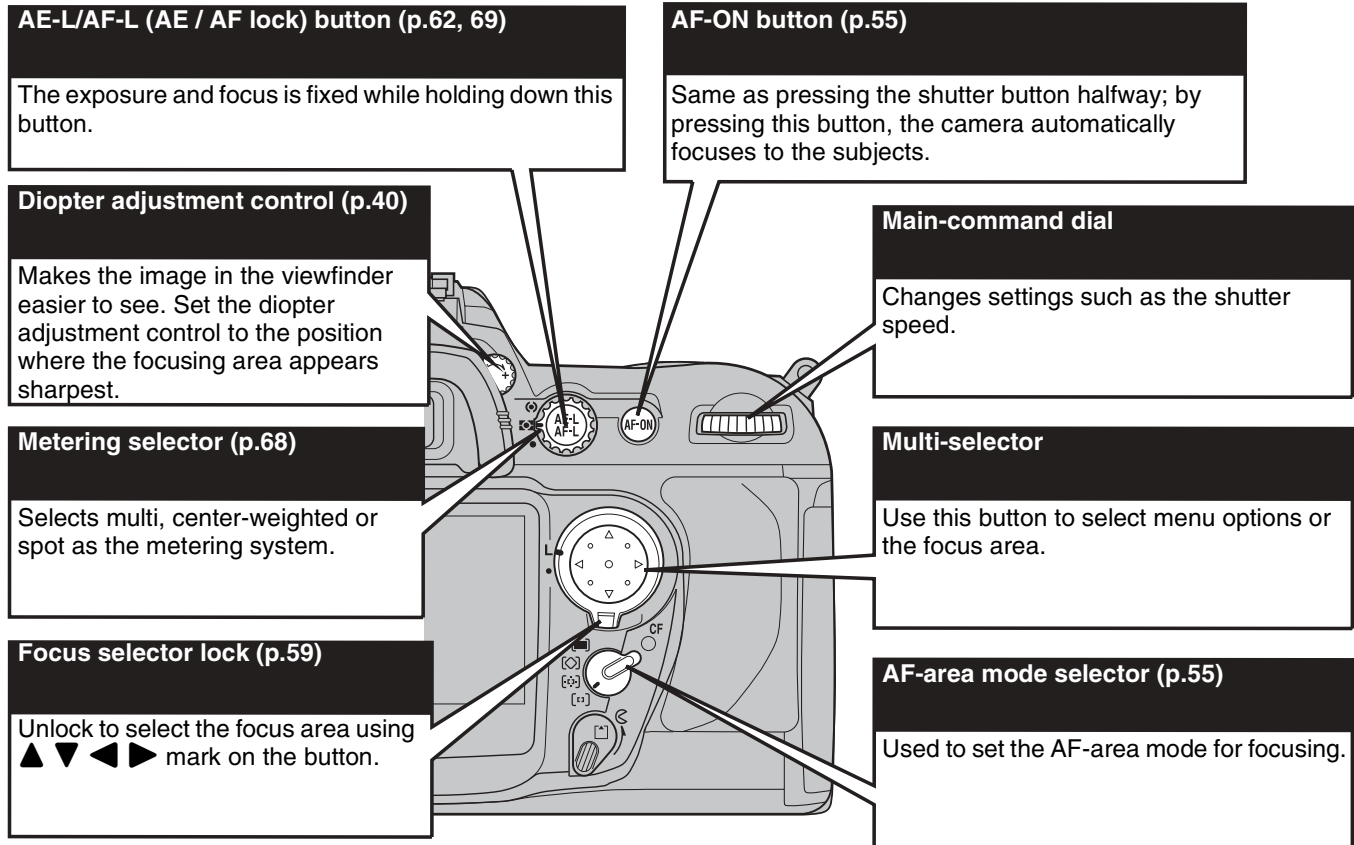

Taking Pictures at Default Settings

This section describes how to take pictures at default settings.

1 Set the power switch to ON to turn the camera on (→p.36).

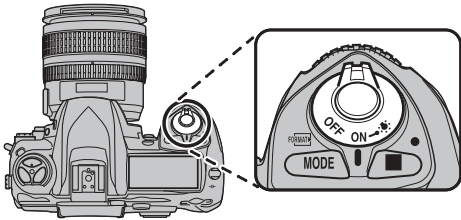

MEMO

- Check the battery level (→p.33).
- Check the number of available frames (→p.49).

2 Adjust camera settings.

- ① Turn the release mode dial to **S** (single frame) while pressing the release mode dial unlock button.
- ② Rotate the AF-area mode selector until it clicks into place pointing to **[+]** (single-area AF).

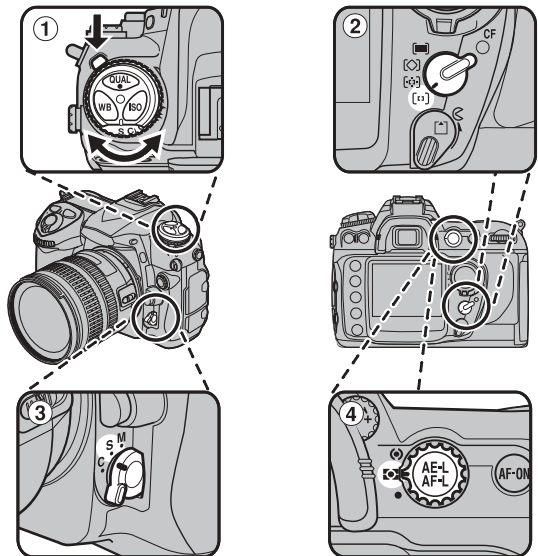

- ③ Rotate the focus-mode selector until it clicks into place pointing to **S** (single-servo AF).
- ④ Rotate the metering selector to (matrix metering).

Continued ➔

Holding the camera correctly

Hold the handgrip in your right hand and cradle the camera body or lens with your left. Brace your elbows against your sides and hold the camera with both hands.



CAUTION

- Moving the camera while shooting gives a blurred picture (camera shake). Hold the camera steadily with both hands.
- If the lens, flash or AF-assist illuminator is obscured by your fingers or the strap, subjects may be out of focus or the brightness (exposure) of your shot may be incorrect.

3 Focus on the main subject in the center focus bracket and press the shutter button down halfway.

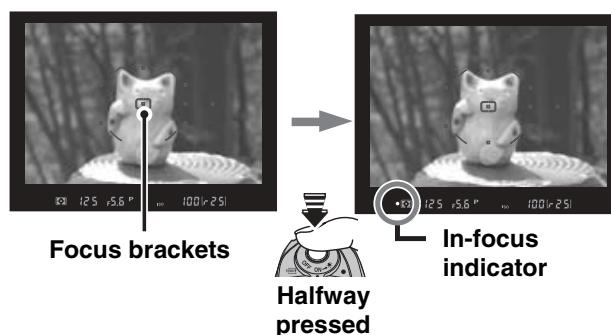

In-focus indicator	Description
● (Lights Steadily)	The subject is in focus.
● (Blinks)	The camera is unable to focus using autofocus.

MEMO

- The shutter button has a halfway point at which focus and exposure are automatically optimized before taking the picture by pressing fully down.
- When pressing the shutter button halfway, a lens operation sound may be heard.

4 Press the shutter button fully.

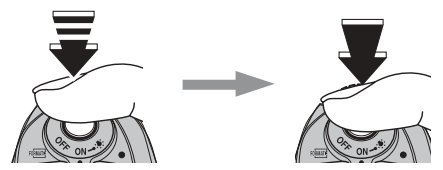

Halfway pressed

Fully pressed

 **MEMO**

When the subject is not in the center focus bracket, use focus lock to take the picture (→p.61).

 **CAUTION**

- See p.212-216 for information on warning displays. See “Troubleshooting” (→p.218-222) for more information.

■ Number of available frames

The exposure count in the control panel and viewfinder show the number of photographs that can be stored on the memory card.

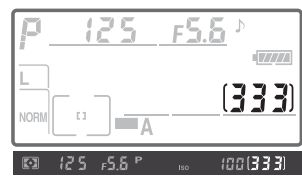

 **MEMO**

See p.226 about the standard number of available frames for the memory card.

Viewing the Images

Playback your images to check them. For important photographs, always take a test shot and view the image to make sure that the camera is working normally.

Setting the camera to playback mode

Press  to change to playback mode.

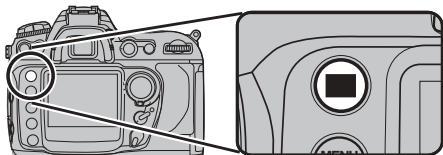

MEMO

When  is pressed, the last shot is played back.

CAUTION

Still images viewable on IS Pro

This camera will display still images recorded on FinePix and still images (excluding some uncompressed images) recorded on any FUJIFILM digital camera that supports memory card. Clear playback or playback zooming may not be possible for still images shot on cameras other than IS Pro.



When playing back images shot with a camera other than IS Pro,  a present icon appears on the screen.

Select the screen display.

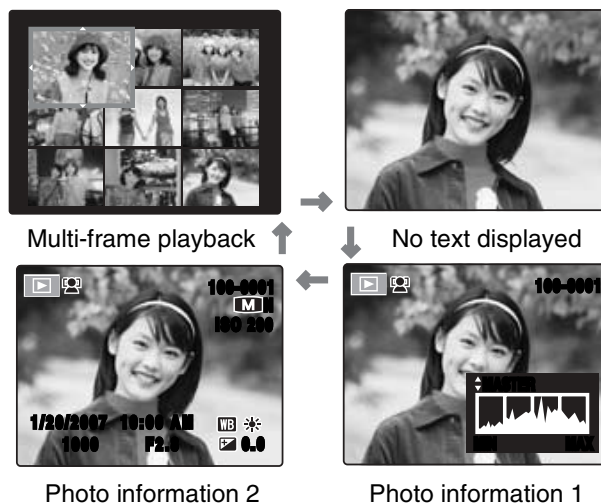
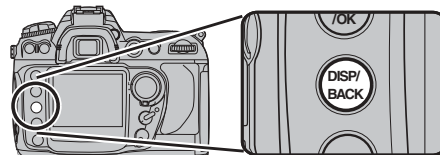
Press DISP/BACK during playback mode to change the screen display.



MEMO

While the screen display is the photo information 1 or 2, press   to display different information.

Single-frame playback



To select the desired image:

Press ◀: previous image

Press ▶: next image

Playback zoom

1 Zoom in / Zoom out.

To zoom in an image during single-frame playback:

▼ button (Zoom out)

▲ button (Zoom in)

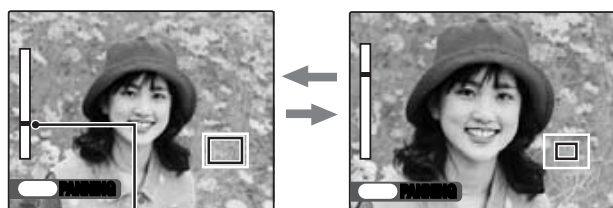

Zoom bar



Press ▲ or ▼ to zoom in or out on an image.

MEMO

Press DISP/BACK to cancel playback zoom.

2 Display another part of the image.

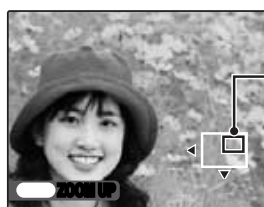

Navigation screen
(Current displayed image)



① Press ▶ to change display mode.



② Press ▲, ▼, ◀, or ▶ to display another part of the image.

MEMO

Press ▶ to return to the playback zoom.

Zoom scales

	Quality mode	Max. zoom scale
L	4256 × 2848	Approx. 5.9×
M	3024 × 2016	Approx. 4.2×
S	2304 × 1536	Approx. 3.2×

Continued ➔

Zoom in face

New feature for images captured with the IS Pro. Press the face zoom in button to zoom directly in on the primary face captured in the image. When no face is recognized, the image is automatically zoomed into the center area.

1 Zoom in on a face (faces).

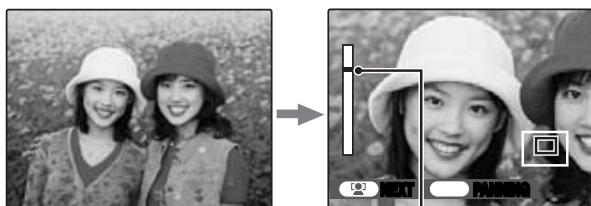

zoom bar

Zoom in on a face (faces).



Each time the face zoom in button is pressed, a different face from the image is zoomed in on (can detect up to a max of 10 faces in each image).

MEMO

Press ▲ or ▼ to perform the playback zoom. Press  to back to the zoom in face.

2 Display another part of the image.



Navigation screen
(Current displayed
image)



① Press  to change display mode.



② Press ▲, ▼, ◀, or ▶ to display another part of the image.



MEMO

Press DISP/BACK to cancel the zoom in face.

Multi-frame playback

Multi-frame playback screen (9 frames) appears on the screen. Select desired frame from the 9 frames.



- 1 Press ▲, ▼, ◀, or ▶ to move the cursor (colored frame) to the desired frame. Press ▲ or ▼ repeatedly to jump to the next page.



- 2 Press MENU/OK to enlarge the image.

MEMO

Press to display the zoom in face screen or playback zoom screen while performing multi-frame playback.

Using the erase button

When performing single-frame playback, use to erase unnecessary images to have ample free space on the memory card.

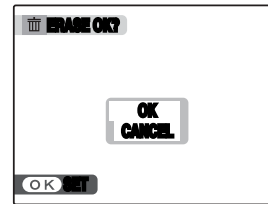

- 1 Press ◀ or ▶ to select the frame (file) to erase.



- 2 Press .



- 3 Press ▲ or ▼ to select [OK].



- 4 Press MENU/OK to erase the frame (file) displayed.

! CAUTION

Erased frames (files) cannot be recovered.

Focus

This section describes the options that control how your camera focuses: focus mode, focus-area selection, and AF-area mode.

Focus mode

Use the focus-mode selector to select the focus mode.

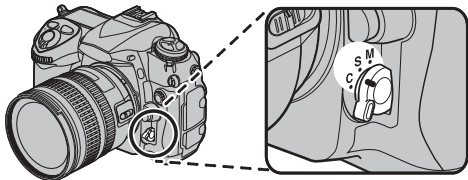

S (Single-servo AF)

Camera focuses when shutter button is pressed halfway. Focus locks when in-focus indicator (●) appears in viewfinder, and remains locked while shutter button is pressed halfway (focus lock). At default settings, shutter can only be released when in-focus indicator is displayed (focus priority).

C (Continuous-servo AF)

Camera focuses continuously while shutter button is pressed halfway. If subject moves, focus will be adjusted to compensate (predictive focus tracking →p.55). At default settings, photographs can be taken whether or not camera is in focus (release priority).

M (Manual)

Camera does not focus automatically; focus must be adjusted manually using the lens focusing ring. If maximum aperture of lens is f/5.6 or faster, viewfinder focus indicator can be used to confirm focus (electronic range finding), but photographs can be taken at any time, whether or not camera is in focus.



MEMO

Manual focus is recommended when the camera is unable to focus using autofocus.

■ The AF-ON button

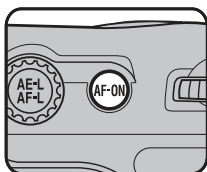

For the purpose of focusing the camera, pressing AF-ON has the same effect as pressing the shutter button halfway.

■ Predictive focus tracking

In continuous-servo AF, the camera will automatically initiate predictive focus tracking if the subject moves while the shutter button is pressed halfway or AF-ON is pressed. In predictive focus tracking, the camera will track focus while attempting to predict where the subject will be when the shutter is released.

⬡ AF-area mode

AF-area mode determines how the focus area is selected in autofocus mode.

Use the AF-area mode selector to select the AF-area mode.

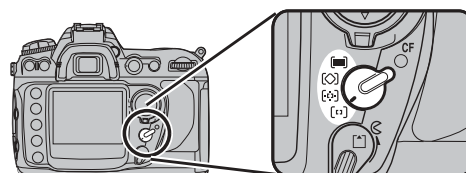

[□] Single-area AF

User selects focus area using multi-selector; camera focuses on subject in selected focus area only. Use for relatively static compositions with subjects that will stay in selected focus area.

[⊞] Dynamic-area AF

User selects focus area manually, but camera uses information from multiple focus areas to determine focus. If subject leaves selected focus area even briefly, camera will focus based on information from other focus areas (focus area selected in viewfinder does not change). Use with continuous-servo AF to follow erratically moving subjects and in other situations in which it is difficult to keep subject in selected focus area.

Continued ➔

[<>] Group dynamic-AF

User chooses focus area group (see below).

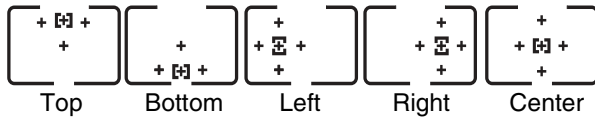

Camera focuses on center of selected group; if subject leaves focus area [AF] even briefly, camera focuses based on information from other focus areas in same group. Use when subject is moving erratically but place of subject in overall composition is known.

[■] Dynamic-area AF with closest subject priority

Camera automatically selects focus area containing subject closest to camera. Prevents out-of-focus shots when photographing erratically moving subjects.

MEMO

Single-area AF is automatically selected when manual focus is used.

AF-area mode display in the control panel

[□] Single-area AF	[□]
[⊕] Dynamic-area AF	[⊕]
[<>] Group dynamic-AF	[<>]
[■] Dynamic-area AF with closest subject priority	[■]

MEMO

- The selected focus area or group of focus areas is shown in the control panel in single-area AF, dynamic-area AF, and group dynamic-AF. The illustrations in the above table show the display when the center focus area or focus area group is selected.
- You cannot focus manually when “Dynamic-area AF with closest subject priority” is set. The control panel display does not show the focus area selected by the camera and the focus area is not displayed in the viewfinder or control panel.

Focus zone selection

When [] (single-area AF) or [] (dynamic-area AF) is selected for AF-area mode (→p.55), the user can select from normal or wide focus areas.

Normal frame (11 Areas)

User can select from eleven focus areas; camera focuses on selected focus area. Use to focus on specific areas of subject.

Wide frame (7 Areas)

User can select from seven focus areas each covering wide area of frame, making it easier to position subject in focus area and reducing time needed to frame photographs. May produce unpredictable results if focus area contains multiple subjects.

■ The display in the control panel and viewfinder

Focus areas are displayed in the control panel and viewfinder as follows:

Normal frame (11 Areas)

	Control panel	Viewfinder
Single-area AF		
Dynamic-area AF		

Wide frame (7 Areas)

	Control panel	Viewfinder
Single-area AF		
Dynamic-area AF		

MEMO

Only the normal frame (11 areas) is available when [] group dynamic-AF or [] dynamic-area AF with closest subject priority is selected for AF-area mode.

Continued ➔

■ **Setting the focus zone in the [SET UP] menu**

See “Using the [SET UP] menu” (→p.138).

Select [FOCUS AREA FRAME] under [AF] in the [SET UP] menu.

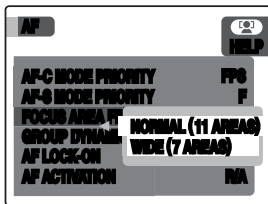

- [NORMAL (11 AREAS)]
Normal Frame (11 Areas)
- [WIDE (7 AREAS)]
Wide Frame (7 Areas)

■ **Setting the focus zone using FUNC. button and sub-command dial**

- ① Select [FOCUS AREA FRAME] for [FUNC. BUTTON] under [BUTTON ASSIGNMENT] in the [SET UP] menu (→p.138, 168).
- ② While pressing the FUNC. button, rotate the sub-command dial.

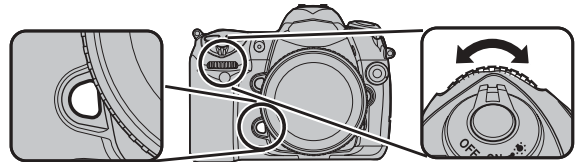

- ③ **WIDE** in the control panel is displayed or hidden.

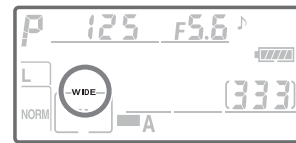

 **MEMO**

When the **WIDE** is displayed, the wide frame (7 Areas) is set. When the **WIDE** is hidden, the normal frame (11 Areas) is set.

Focus area selection

At default settings, the IS Pro offers a choice of eleven focus areas that together cover a wide area of the frame. The focus area can be selected manually, allowing photographs to be composed the main subject positioned almost anywhere in the frame, or automatically to ensure that the subject closest to the camera is always in focus regardless of where it is in the frame.



- 1 Turn the focus selector lock to the ● position.

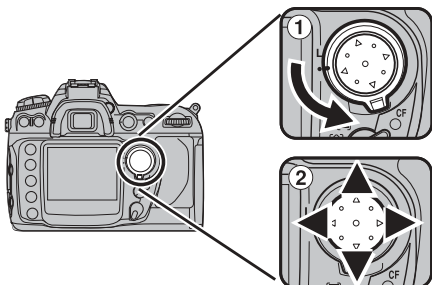

- 2 Press ▲▼◀▶ on the multi-selector to select focus area. To select the center focus area (or focus area group) at any time, press the center of the multi-selector.
- 3 The focus selector lock can be rotated to the L (locked) position following selection to prevent the selected focus area from changing when the multi-selector is pressed.

MEMO

- The focus area cannot be changed when auto power save is activated, during playback, or while a menu is displayed.
- When the AF-area mode is set to the group dynamic-AF (→p.56), the focus area can be selected by group.
- When the AF-area mode is set to the dynamic-area AF with closest subject priority (→p.56), the focus-area cannot be selected.

Manual focus

Use manual focus in situations where autofocus may not work as expected (→p.63) or a lens other than an AF Nikkor lens is attached.

- 1 Set the focus-mode selector to **M**.

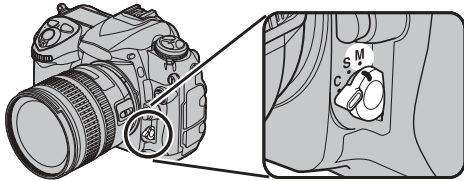

- 2 Adjust the lens focusing ring until the image displayed on the clear matte field in the viewfinder is in focus. Photographs can be taken at any time, even when the image is not in focus.

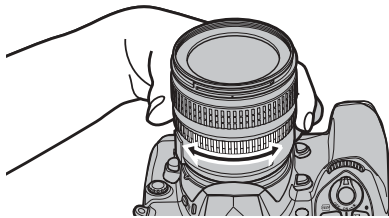

MEMO

- When using a lens that offers A-M selection, select M when focusing manually. With lenses that support M/A (autofocus with manual priority), focus can be adjusted manually with the lens set to M or M/A. See the documentation provided with your lens for details.
- Use manual focus while monitoring an image on the LCD monitor using the live view display.

Focal plane mark

To determine the distance between your subject and the camera, measure from the focal plane mark on the camera body. The distance between the lens mounting flange and the focal plane is 46.5 mm (1.83 in.).

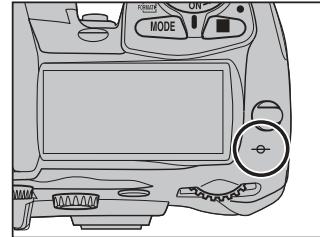

■ Focus aid

This allows you to check the focus of your shot using the focus indicator ● in the viewfinder. You can use focus aid when the lens mounted has an f-stop setting brighter than f/5.6.



- ① Set the focus-mode selector to **M**.
- ② Position the selected focus area over the object on which you want to focus.
- ③ Turn the focusing ring on the lens.
- ④ Press the shutter button down halfway. When the shot is in focus, the focus indicator ● lights.

⬡ Focus lock

Focus lock can be used to change the composition after focusing, making it possible to focus on a subject that will not be in a focus area in the final composition. It can also be used when the autofocus system is unable to focus (→p.63).



1 Focus on a subject.

- ① Position the subject in the selected focus area.
- ② Press the shutter button halfway. Check that the in-focus indicator ● appears in the viewfinder.



Halfway pressed



Continued ➔

2 Lock the focus.

Single-servo AF

Focus will lock automatically when the in-focus indicator appears, and remain locked until your finger is removed from shutter button.

Continuous-servo AF

Press AE-L/AF-L to lock both focus and exposure. Focus will remain locked while AE-L/AF-L is pressed, even if your finger is removed from the shutter button.

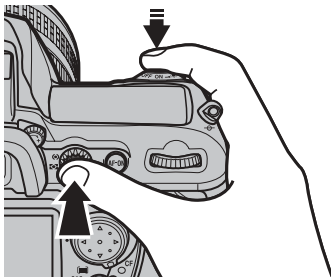

3 Move the camera to recompose while pressing the shutter button halfway, then press fully.

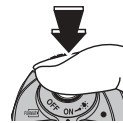

Fully pressed



MEMO

- You can reapply the focus lock as many times as you like before releasing the shutter.
- Do not change the distance between the camera and the subject while focus lock is in effect. If the subject moves, focus again at the new distance.
- In single-servo AF, focus will remain locked between shots as long as the shutter button is kept pressed halfway, allowing several photographs in succession to be taken at the same focus setting. Focus will also remain locked between shots while AE-L/AF-L is pressed.

Getting good results with autofocus

Autofocus does not perform well under the conditions listed below. If the camera is unable to focus using autofocus, use manual focus (→p.60) or use focus lock (→p.61) to focus on another subject at the same distance and then recompose the photograph.

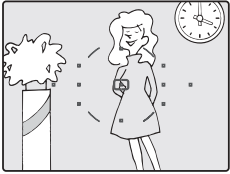

There is little or no contrast between the subject and the background.
Example: subject is the same color as the background.



The focus area contains objects at different distances from the camera.
Example: subject is inside a cage.

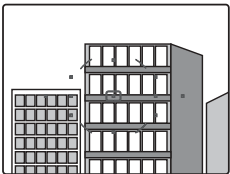

The subject is dominated by regular geometric patterns.
Example: a row of windows in a skyscraper.



The focus area contains areas of sharply contrasting brightness.
Example: subject is half in the shade.



The subject appears smaller than the focus area.
Example: focus area contains both foreground subject and distant buildings.

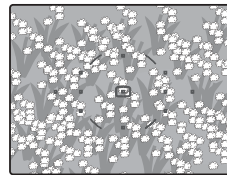

The subject contains many fine details.
Example: a field of flowers or other subjects that are small or lack variation in brightness.

The AF-assist illuminator

The built-in AF-assist illuminator enables the camera to focus even when the subject is poorly lit. The camera must be in focus mode **S** (single-servo autofocus), an AF-Nikkor lens must be attached, and the center focus area or focus area group must be selected or closest subject priority in effect. If these conditions are met and the subject is poorly lit, the illuminator will light automatically to assist the autofocus operation when the shutter button is pressed halfway.

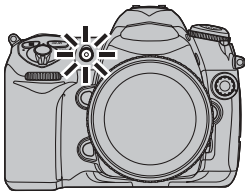

CAUTION

After the AF-assist illuminator has been used for several consecutive shots, it may turn off briefly to protect the lamp. The illuminator can be used again after a short pause. Note that the illuminator may become hot with continuous use.

MEMO

- For the AF-assist illuminator to function correctly, the lens must have a focal length of 24-200 mm and the subject must be in range of the illuminator. Lens hoods should be removed. With most lenses, the illuminator has a range of about 0.5-3 m (1 ft. 8 in.-9 ft. 10 in.).
- AF-assist is not available with the AF-S VR ED 200-400 mm f/4G.

■ Lenses for which vignetting occurs

- Autofocus using the camera's AF-assist illuminator cannot be performed due to vignetting with the following lenses at shooting distance within 0.7 m (2 ft. 4 in.):
 - AF Micro ED 200 mm f/4D
 - AF-S ED 28-70 mm f/2.8D
 - AF-S VR ED 24-120 mm f/3.5-5.6G
 - AF Micro ED 70-180 mm f/4.5-5.6D
- Autofocus using the camera's AF-assist illuminator cannot be performed due to vignetting with following lenses at shooting distance within 1 m (3 ft. 3 in.):
 - AF-S DX ED 55-200 mm f/4-5.6G
- Autofocus using the camera's AF-assist illuminator cannot be performed due to vignetting with following lenses at shooting distance within 1.5 m (4 ft. 11 in.):
 - AF-S VR ED 70-200 mm f/2.8G
 - AF ED 80-200 mm f/2.8D
 - AF-S ED 80-200 mm f/2.8D
- Autofocus using the camera's AF-assist illuminator cannot be performed due to vignetting with following lenses at shooting distance within 2.5 m (8 ft. 2 in.):
 - AF VR ED 80-400 mm f/4.5-5.6D

■ Nikon flash units and active assist illuminator

Under the conditions described above, the Nikon SB-800 and SB-600 Speedlights and SU-800 wireless Speedlight commander will provide active AF illumination for the following focus areas:

AF lens focal length	Normal frame (11 areas)	Wide frame (7 areas)
24-34 mm		
35-70 mm		
71-105 mm		

With other Speedlights, the camera AF-assist illuminator will be used.

Depth-of-field preview button

To preview the effects of aperture, press and hold the depth-of-field preview button. The lens will be stopped down to the aperture value selected by the camera (modes *P* and *S*) or the value chosen by the user (modes *A* and *M*), allowing depth of field to be previewed in the viewfinder.

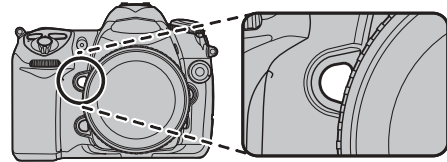

Release

The shooting operation can be selected from **S** (single-frame), **C_L** (continuous low speed), **C_H** (continuous high speed), **☺** (self-timer), or **M_{UP}** (mirror up) using the release mode dial.

Press the release mode dial unlock button and turn the release mode dial to the desired setting.

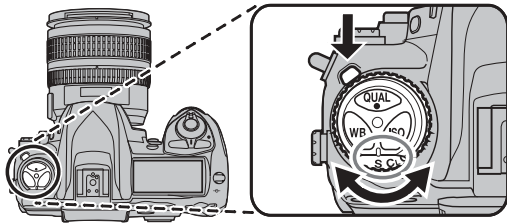

S Single frame

Camera takes one photograph each time the shutter button is pressed. Access lamp will light while photo is recorded; next shot can be taken immediately if enough space remains in memory buffer.

C_L Continuous low speed

While shutter button is held down, camera records 1-2 frames per second.*

C_H Continuous high speed

While shutter button is held down, camera records up to 3 frames per second.* Use to photograph moving objects or to capture a fleeting expression on portrait subjects.

☺ Self-timer

Use the self-timer for self-portraits or to reduce blurring caused by camera shake (→p.101).

M_{UP} Mirror up

Press shutter button once to raise mirror, again to take photograph (shutter will be released automatically if shutter button is not pressed for 30 sec. after mirror up). Mirror will be lowered after shutter is released. Choose this mode to minimize camera shake in situations in which the least camera movement can result in blurred photographs. Note that autofocus, metering, and framing cannot be confirmed in the viewfinder while mirror is raised.

* If the following conditions apply: Average frame rate with continuous-servo AF, manual or shutter-priority auto exposure, a shutter speed of 1/250s or faster, ISO 200, [100% (STD)] is selected for [D-RANGE] in the [SHOOTING MENU], and enough memory remains in memory buffer.

MEMO

When **C_L** (continuous low speed) or **C_H** (continuous high speed) is selected, the continuous shooting speed and interval may be slower, depending on the setting for [D-RANGE] in the [SHOOTING MENU].

■ Buffer Size

- The number of shots available before the memory buffer is full is displayed in the viewfinder and control panel while the shutter button is pressed. The continuous shooting can record up to 100 frames.
- If 0 is displayed, the memory buffer is full and shooting will slow.
- The number of shots available before the memory buffer is full, which is displayed in the viewfinder and control panel, varies depending on the capacity of the memory card or shooting conditions.



MEMO

- In continuous mode, the orientation recorded for the first shot applies to all photographs in the same burst, even if camera orientation is changed during shooting.
- While photographs are being recorded to the memory card, the access lamp next to the memory card slot will light. Depending on the memory card type, image size (RECORDING PIXELS) or image quality (QUALITY), recording time may vary from a few seconds to a few minutes. Do not remove the memory card or disconnect the power source until the access lamp has gone out. If the camera is switched off while data remains in the buffer, the power will not turn off until all images in the buffer have been recorded. If the battery is exhausted while images remain in the buffer, the shutter release will be disabled and the images transferred to the memory card.

Metering

Normally, the matrix metering system will provide the optimum exposure for your shot. However, you can choose from 3 metering modes for shots where you want to select a different exposure level (AE lock or exposure compensation) or for particular scenes (such as backlit shots or shots with very strong contrast).

Turn the metering selector to desired metering system.

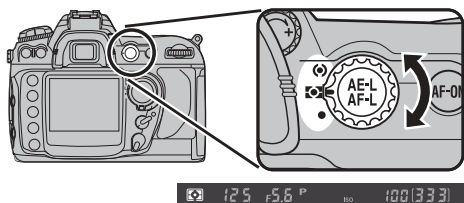

Matrix metering

1,005-pixel RGB sensor sets exposure based on variety of information from all areas of frame. With type G or D lens, camera uses 3D color matrix metering II for natural results even when frame is dominated by bright (white or yellow) or dark (black or dark green) colors.

With other CPU lenses, 3D range information is not included; instead, camera uses color matrix metering II. Color matrix metering is available when a non-CPU lens is attached and if the focal length and maximum aperture of the lens are specified for [NON-CPU LENS DATA] under [MISC.] in the [SET UP] menu (→p.121; the center-weighted metering is used if focal length or aperture is not specified).

- For AE lock (→p.69) or Exposure compensation (→p.76), the Spot metering is recommended.

Center-weighted

Camera meters entire frame but assigns greatest weight to area in center of frame 8 mm (0.31 in.) in diameter, shown by corresponding 8-mm reference circle in viewfinder.

MEMO

The metering diameter can be changed by the [CENTER-WEIGHT AREA] setting under [EXPOSURE] in the [SET UP] menu. Also, the average metering value of the entire frame is available (→p.157).

Spot

Camera meters circle 3 mm (0.12 in.) in diameter (approximately 2.0% of frame). Ensures that subject will be correctly exposed, even when back ground is much brighter or darker.

- Circle is centered on current focus area (in group dynamic AF, on center focus area of current group; →p.56), making it possible to meter off-center subjects (if non-CPU lens is used or if dynamic-area AF with closest subject priority is in effect, camera will meter center focus area).

MEMO

- For improved precision with non-CPU lenses, specify lens focal length and maximum aperture in [NON-CPU LENS DATA] under [MISC.] in the [SET UP] menu.
- When using non-CPU lens, center-weighted metering is used if focal length or aperture is not specified in [NON-CPU LENS DATA] under [MISC.] in the [SET UP] menu.
- Center-weighted is recommended when using filters with an exposure factor (filter factor) over 1x.

Taking Pictures with AE Lock

AE lock allows you to set the exposure for a specific subject in your shot. This technique is useful when brightness of your subject differs greatly from its surroundings.

- ① Set the exposure mode other than **M** (manual) (→p.70).
- ② Set the metering selector to **[M]** center-weighted or **[S]** spot metering.
Matrix metering is not recommended since the effect of the AE lock cannot be effectively attained.

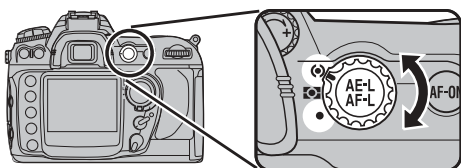

- ③ Position the focus area over the subject you want correctly exposed, press and hold the shutter button down halfway and then press AE-L/AF-L. Confirm that the in focus indicator (●) appears in the viewfinder.

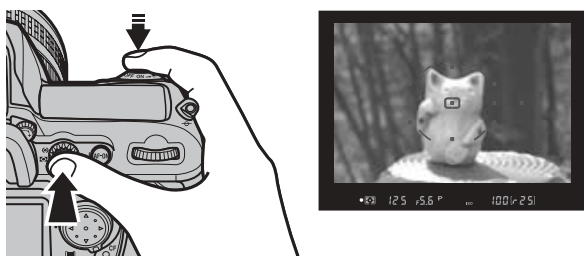

MEMO

- While AE lock is in effect, exposure will not be changed by changing the frame. Also, **AE-L** indicator will appear in the viewfinder.
- In spot metering, exposure will be locked at the value metered in a 3-mm (0.12 in.) circle centered on the selected focus area. In center-weighted metering, exposure will be locked at the value metered in an 8-mm (0.31 in.) circle at the center of the viewfinder.
- Depending on the option selected, AE-L/AF-L locks both focus and exposure (the default setting), only focus, or only exposure. Options are available for keeping exposure locked until AE-L/AF-L is pressed a second time, the shutter is released, or exposure meters turn off.

- ④ Keeping AE-L/AF-L pressed, recompose the photograph and shoot.



MEMO

- While AE-L/AF-L is being pressed, the following operation can be performed:
 - When exposure mode is **P**: Flexible program (→p.71)
 - When exposure mode is **S**: Changing Shutter speed
 - When exposure is **A**: Changing Aperture
The new shutter speed and exposure values are displayed in the exposure display after the change.
- Rotating the metering selector to another setting does not change the metering system during AE Lock operation. Release the AE lock.

Exposure Mode

Four modes are available: programmed auto (**P**), shutter-priority auto (**S**), aperture-priority auto (**A**), and manual (**M**).

P Programmed auto

This mode automatically controls the shutter speed and aperture setting to give the optimum exposure for the photography conditions. This mode is useful when you want to be able to take pictures quickly and easily to take advantage of snapshot opportunities.

- ① While pressing MODE, rotate the main-command dial until **P** is displayed in the control panel.

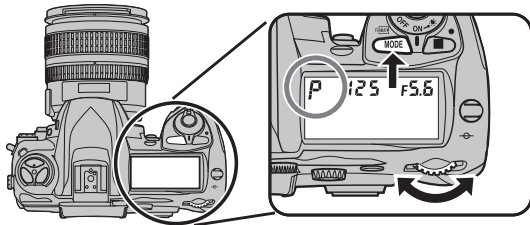

- ② Frame a photograph, focus, and shoot.

MEMO

- Programmed auto is only available with CPU lenses.
- Exposure mode **A** (aperture-priority auto) is automatically selected when a non-CPU lens is attached. The exposure-mode indicator **P** will blink in the control panel and **A** will be displayed in the viewfinder.
- If the limits of the exposure metering system are exceeded, one of the following indicators will be displayed in the control panel and viewfinder:
 - H** : Subject too bright. Use optional neutral density (ND) filter or lower ISO sensitivity.
 - L** : Subject too dark. Use flash or raise ISO sensitivity.

Flexible program

In mode **P**, different combinations of shutter speed and aperture can be selected by rotating the main-command dial (“flexible program”). All combinations produce the same exposure. While flexible program is in effect, an asterisk (“*”) appears next to the exposure-mode indicator in the control panel.

To restore default shutter speed and aperture settings, rotate the main-command dial until the indicator is no longer displayed. Default settings can also be restored by turning the camera off, selecting another exposure mode, performing a two-button reset (→p.120) or change the setting for the [EV CONTROL STEPS] under [EXPOSURE] in the [SET UP] menu.



Program chart

The program chart shows exposure control in flexible program (ISO 100).

— ISO 100; lens with maximum aperture of f/1.4 and minimum aperture of f/16 (e.g., AF 50 mm f/1.4 D)

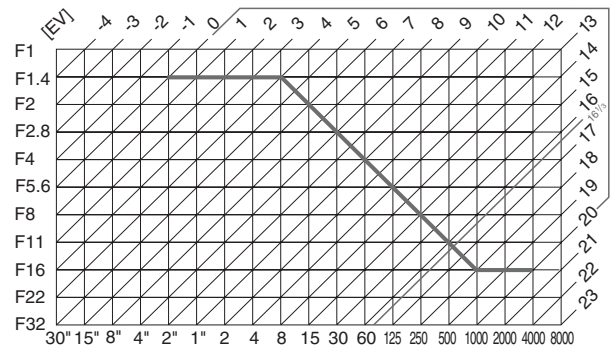

- The maximum and minimum values for EV vary with sensitivity (ISO equivalency); the above graph assumes a sensitivity of ISO 100 equivalent.
- When matrix metering is used, values over 16 1/3 EV are reduced to 16 1/3 EV in case of ISO 100.

S Shutter-priority auto

In shutter-priority auto, you choose the shutter speed while the camera automatically selects the aperture that will produce the optimum exposure. Shutter speed can be set to values between 30s and 1/8000s. Use slow shutter speeds to suggest motion by blurring moving objects, high shutter speeds to “freeze” motion.

- ① While pressing MODE, rotate the main-command dial until **S** is displayed in the control panel.

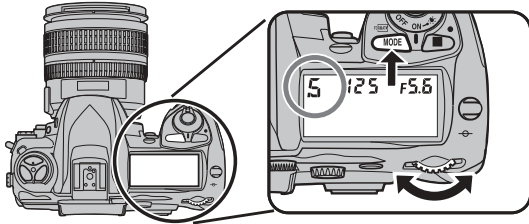

- ② Rotate the main-command dial to choose the desired shutter speed (between 30s and 1/8000s).

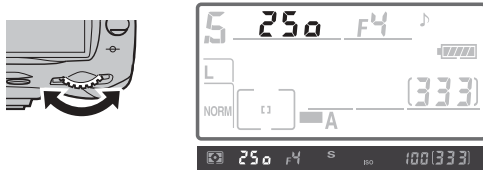

- ③ Frame a photograph, focus, and shoot.

MEMO

- Shutter-priority auto is only available with CPU lenses.
- Exposure mode **A** (aperture-priority auto) is automatically selected when a non-CPU lens is attached. The exposure-mode indicator **S** will blink in the control panel and **A** will be displayed in the viewfinder.
- If you select a shutter speed of **bulb** in mode **M** and then select mode **S** without changing the shutter speed, the shutter-speed display will flash and the shutter cannot be released. Rotate the main command dial to select a different shutter speed before shooting.
- If the limits of the exposure metering system are exceeded, one of the following indicators will be displayed in the control panel and viewfinder:
 - H** : Subject too bright. Choose faster shutter speed or lower ISO sensitivity (→p.92), or use optional neutral density (ND) filter.
 - L** : Subject too dark. Choose slower shutter speed or higher ISO sensitivity (→p.92), or use flash.
- Use a battery with sufficient power when performing bulb shooting.

Aperture-priority auto

In this mode, the photographer sets the aperture (minimum aperture to maximum aperture) and the camera automatically controls the shutter speed. This mode is best for photographs where the priority is on the depth of field (the area where objects are in focus), such as shots where both near and distant objects are in clear focus (minimum apertures) or where the background is out of focus (maximum apertures).

- ① While pressing MODE, rotate the main-command dial until **A** is displayed in the control panel.

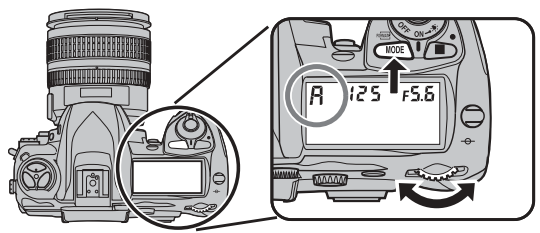

- ② Rotate the sub-command dial to choose the desired aperture.

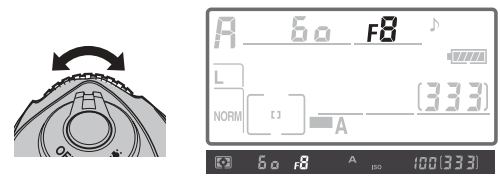

- ③ Frame a photograph, focus, and shoot.

MEMO

- When a non-CPU lens is attached and if the maximum aperture of the lens has been specified in the [NON-CPU LENS DATA] under [MISC.] (→p.121) in the [SET UP] menu, the current f/-number will be displayed in the control panel and viewfinder, rounded to the nearest full stop. Otherwise the aperture displays will show only the number of stops (**ΔF**, with maximum aperture displayed as **ΔF0**) and the f/-number must be read from the lens aperture ring.

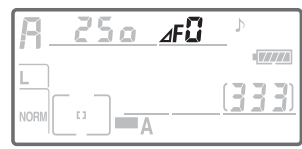

- If the limits of the exposure metering system are exceeded, one of the following indicators will be displayed in the control panel and viewfinder:
 - H †** : Subject too bright. Choose smaller aperture (larger f/-number) or ISO sensitivity (→p.92), or use optional neutral density (ND) filter.
 - L †** : Subject too dark. Choose larger aperture (smaller f/-number) or higher ISO sensitivity (→p.92), or use flash.
- If aperture ring of CPU lens (except G type) is not set to minimum aperture, **F E E** blinks in the control panel and viewfinder. In this case, the shutter cannot be released regardless of the exposure mode selected.

Manual

In this mode, the photographer is free to set any shutter speed (1/8000 sec. to 30 sec. or *bulb*) and aperture setting (minimum aperture to maximum aperture). This allows the photographer to determine the exposure to suit the conditions and the desired effect while watching the electronic analog exposure display in the viewfinder.

- ① While pressing MODE, rotate the main-command dial until **M** is displayed in the control panel.

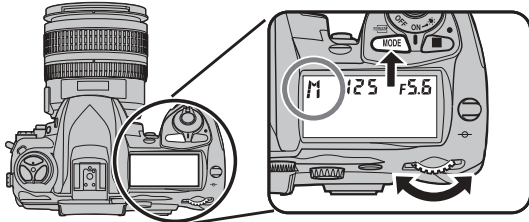

- ② While checking the electronic analog exposure display, set the shutter speed and aperture. Either one can be set before the other.

Shutter speed:

Use the main-command dial to set.

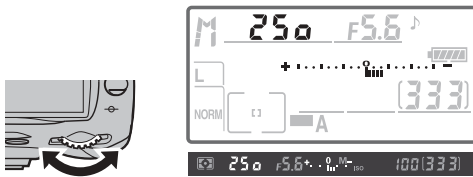

Aperture:

Use the sub-command dial to set.

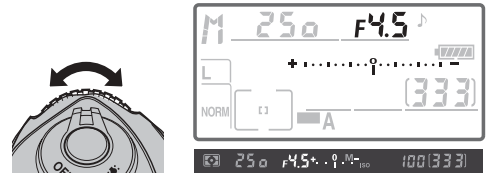

- ③ Frame a photograph, focus, and shoot.

MEMO

When the shutter speed is set to *bulb* in step ②, the shutter remains open for as long as you hold the shutter button in the down position.

Electronic analog exposure display

At shutter speeds other than $\frac{1}{250}$ to $\frac{1}{8}$, the electronic analog exposure display in the control panel and viewfinder show whether the photograph would be under- or over exposed at current settings.

The electronic analog exposure display is displayed in the control panel and viewfinder as below.

[EV CONTROL STEPS] set to [1/3 EV STEP]

	Control panel	Viewfinder
Optimal exposure	+ 0 -	+ 0 -
Underexposed by 1/3 EV	+ 0 -	+ 0 -
Overexposed by more than 3 EV	+ 0 -	+ 0 - *

[EV CONTROL STEPS] set to [1/2 EV STEP]

	Control panel	Viewfinder
Optimal exposure	+ 0 -	+ 0 -
Underexposed by 1/2 EV	+ 0 -	+ 0 -
Overexposed by more than 3 EV	+ 0 -	+ 0 -

[EV CONTROL STEPS] set to [1 EV STEP]

	Control panel	Viewfinder
Optimal exposure	+ 0 -	+ 0 -
Underexposed by 1 EV	+ 0 -	+ 0 -
Overexposed by more than 3 EV	+ 0 -	+ 0 -

* If overexposure exceeds more than 2 EV at 1/3 EV STEP, the electronic analog exposure display in the viewfinder appears as this.

- If the limits of the exposure metering system are exceeded, the electronic analog exposure display will flash for warning.

Continued ➔

 MEMO



- At a shutter speed of $\frac{1}{250}$, the shutter will remain open while the shutter button is held down. Using a fully-charged rechargeable NP-150 battery or the optional AC135VN adapter is recommended to prevent loss of power while the shutter is open. If the battery is exhausted during shooting, the camera will record the photograph to the memory card and then turn off automatically.
- When a non-CPU lens is attached and if the maximum aperture of the lens has been specified in the [NON-CPU LENS DATA] under [MISC.] (→p.121) in the [SET UP] menu, the current f/-number will be displayed in the viewfinder and control panel, rounded to the nearest full stop. Otherwise the aperture displays will show only the number of stops (ΔF , with maximum aperture displayed as $\Delta F \square$) and the f/-number must be read from the lens aperture ring.





- When an AF Micro Nikkor lens is attached and an external exposure meter is used, the exposure ratio only needs to be factored when the lens aperture ring is used to set the aperture.

 Exposure compensation

Exposure compensation allows you to intentionally vary the optimum exposure value controlled by the camera. This can be useful when intentionally achieving under- or overexposure. Use center-weighted or spot metering because matrix metering cannot achieve sufficient effect. Exposure compensation can be performed in any exposure mode (However in *M* exposure mode, only the electronic analog exposure display changes—selected shutter speed and aperture do not change).

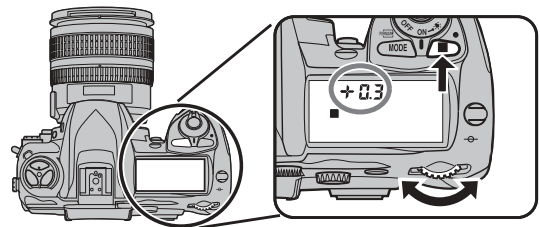
- ① While pressing the , rotate the main-command dial and confirm exposure compensation in the control panel or the viewfinder (in the viewfinder, positive values are shown by a  icon, negative values by a  icon). Exposure compensation can be set to values between -5 EV (underexposure) and +5 EV (overexposure) in increments of 1/3 EV.



When the exposure compensation is set,  appears on the control panel.

The compensation value can be checked by pressing the .



The electronic analog exposure displays is displayed as exposure compensation in the control panel and viewfinder. “0” blinks in electronic analog exposure display.

② Frame a photograph, focus, and shoot.

MEMO

- To cancel exposure compensation, set the compensation amount to “0.0” or perform a two-button reset (→p.120). (Turning the camera off does not cancel exposure compensation.)
- Normally, you should compensate exposure to the + side when the background is brighter than your main subject, or to the – side when the background is darker.

Flash Photography

Built-in flash

This camera is equipped with a guide number 12 flash (ISO 100, m/ft) that can be used not only when natural lighting is inadequate, but also to fill in shadows and backlit subjects or to add a catch light to the subject's eyes.

i-TTL balanced Fill-Flash for Digital SLR

Speedlight emits series of nearly invisible preflashes (monitor preflashes) immediately before main flash. Preflashes reflected from objects in all areas of frame are picked up by 1,005-pixel RGB sensor and are analyzed in combination with information from matrix metering system to adjust flash output for natural balance between main subject and ambient background lighting.

- If type G or D lens is used, distance information is included when calculating flash output.
- Precision of calculation can be increased for non-CPU lenses by providing lens data (focal length and maximum aperture; →p.121).
- Not available when spot metering is used.

Standard i-TTL Flash for Digital SLR

Flash output adjusted to bring lighting in frame to standard level; brightness of background is not taken into account. Recommended for shots in which main subject is emphasized at expense of background details, or when exposure compensation is used.

- Standard i-TTL flash for Digital SLR is activated automatically when spot metering is selected.

MEMO

- i-TTL flash control can adjust for ISO sensitivities between 100 and 1600. It may not be able to adjust flash level appropriately for ISO sensitivities over 1600.
- The flash angle of the built-in flash can cover the field of view of an 18 mm lens. It may not be able to light the entire subject with some lenses or apertures.
- When [ON] is selected for [ISO AUTO CONTROL] under [ISO AUTO CONTROL] under [ EXPOSURE] in the [SET UP] menu, ISO sensitivity will automatically be adjusted as required for optimal flash output. This may result in foreground subjects being underexposed in flash photographs taken at slow shutter speeds, in daylight, or against a bright background. In these cases, choose a flash mode other than slow sync or select mode **A** or **M** and choose a larger aperture.

Using the Built-in flash

To use the built-in flash:

- 1 Choose a metering method.

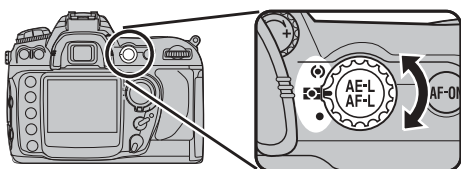

MEMO

- Select matrix or center-weighted metering to activate i-TTL Balanced Fill-Flash for Digital SLR.
- Standard i-TTL Flash for Digital SLR is activated automatically when spot metering is selected.

- 2 Press the flash pop-up button. The built-in flash will raise and begin charging.

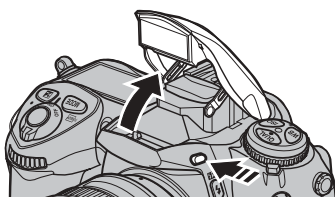

- 3 Set the flash sync mode. (→p.82).



- 4 Set the exposure mode, shutter speed and aperture. The shutter speeds and apertures available when the built-in flash is raised (→p.80).

- 5 Check that the ⚡ flash-ready indicator appears in the viewfinder.





MEMO

If the ⚡ flash-ready indicator is not displayed when the built-in flash is used, the shutter release will be disabled.

- 6 Compose the photograph, making sure that the subject is within range of the flash, then focus and shoot.

Continued ➔

 **MEMO**

- If the  flash-ready indicator blinks for about three seconds after the photograph is taken, the flash has fired at full output and the photograph may be underexposed. Check the results in the monitor. If the photograph is underexposed, adjust settings and try again.
- If the built-in flash is used in continuous shooting mode, only one photograph will be taken each time the shutter button is pressed.
- Vibration reduction (available with VR lenses) does not take effect if the shutter button is pressed halfway while the built-in flash is recharging.
- After the built-in flash has been used for several consecutive shots, it may turn off briefly to protect the flash. The built-in flash can be used again after a short pause.
- The built-in flash and Nikon SB-800, SB-600, and SB-R200 Speedlights emit a modeling flash when the camera depth-of-field preview button is pressed. Modeling illumination can be turned off by selecting [OFF] for the [MODELING FLASH] (→p.165) under [ FLASH/BKT] in the [SET UP] menu.

To close the built-in flash

To save battery power when the built-in flash is not in use, return it to the closed position by pressing it lightly downward until the latch clicks into place.

■ The shutter speeds and apertures available when the built-in flash is raised

Exposure mode	Shutter speed	Aperture
P (→p.70)	Set automatically by camera (1/250-1/60s) *1	Set automatically by camera
S (→p.72)	Value selected by user (1/250–30 s) *2	
A (→p.73)	Set automatically by camera (1/250-1/60s) *1	Value selected by user *3
M (→p.74)	Value selected by user (1/250–30 s) *2	

*1 Regardless of option selected, camera may set shutter to speeds as slow as 30 s at flash sync settings of slow sync, slow rear-curtain sync, and slow sync with red-eye reduction.

*2 Speeds faster than 1/250s will be reduced to 1/250s when built-in flash is popped up.

*3 Flash range varies with ISO sensitivity and aperture. Consult table of flash of flash ranges (→p.81) when setting aperture in **A** and **M** modes.

■ Effective range of the built-in flash

The effective range of the built-in flash varies depending on the ISO sensitivity and aperture settings used.

Aperture at ISO equivalent of:													Metering range
100	125	160	200	250	320	400	500	640	800	1000	1250	1600	
1.4	1.6	1.8	2	2.2	2.5	2.8	3.2	3.5	4	4.5	5	5.6	1-7.5m (3.3–24.6 ft.)
2	2.2	2.5	2.8	3.2	3.5	4	4.5	5	5.6	6.3	7.1	8	0.7-5.4m (2.3–17.7 ft.)
2.8	3.2	3.5	4	4.5	5	5.6	6.3	7.1	8	9	10	11	0.6-3.8m (2.0–12.5 ft.)
4	4.5	5	5.6	6.3	7.1	8	9	10	11	13	14	16	0.6-2.7m (2.0–8.9 ft.)
5.6	6.3	7.1	8	9	10	11	13	14	16	18	20	22	0.6-1.9m (2.0–6.2 ft.)
8	9	10	11	13	14	16	18	20	22	25	29	32	0.6-1.4m (2.0–4.6 ft.)
11	13	14	16	18	20	22	25	29	32	—	—	—	0.6-0.9m (2.0–2.9 ft.)
16	18	20	22	25	29	32	—	—	—	—	—	—	0.6-0.7m (2.0–2.3ft.)

* The minimum effective range for flash control using the built-in flash is 0.6 meters.

In programmed auto, the maximum aperture (minimum f/-number) is limited according to sensitivity (ISO equivalency), as shown below:

Maximum aperture at ISO equivalent of:													
100	125	160	200	250	320	400	500	640	800	1000	1250	1600	
2.8	3	3.2	3.3	3.5	3.8	4	4.2	4.5	4.8	5	5.3	5.6	

* For each one-step increase in sensitivity (e.g., from 200 to 400), aperture is stopped down by half an f/-stop. If the maximum aperture of the lens is smaller than given above, the maximum value for aperture will be the maximum aperture of the lens.

MEMO

i-TTL flash control can adjust for ISO sensitivities between 100 and 1600. It may not be able to adjust flash level appropriately for ISO sensitivities over 1600.

⬡ Synchro modes and their features

You can select any of 5 modes to suit the type of shot and the desired effect.

While pressing , rotate the main command-dial until the desired flash sync icon is displayed in the control panel.

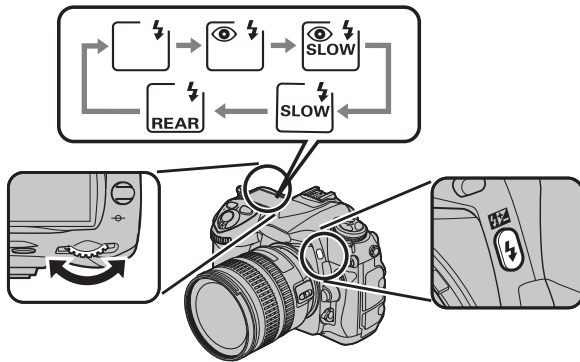

See p.78 for details of flash shooting.

⚠ CAUTION

Some lenses may block the red-eye reduction lamp, preventing the subject from seeing the lamp and interfering with red-eye reduction.

Front-curtain sync

Recommended for most situations. In programmed auto and aperture-priority auto modes, shutter speed will automatically be set to values between 1/60 and 1/250s (1/60 to 1/8,000s when using optional Speedlight with auto FP high-speed sync; →p.88).

Red-eye reduction

Red-eye reduction pre-flash lights for approximately one second before main flash. Pupils in subject's eyes to contract, reducing "red-eye" effect sometimes caused by flash.



- Be aware that the camera and the subjects (people) in the shot do not move until the shutter is released.

SLOW Red-eye reduction with slow sync

Combines red-eye reduction with slow sync. This mode is only available in programmed auto and aperture-priority auto exposure modes.

- Use of tripod is recommended to prevent blurring caused by camera shake.

⚠ CAUTION

Only available in exposure modes **P** and **A**.   (red-eye reduction) is selected in modes **S** and **M**.

SLOW Slow sync

Flash is combined with speeds as slow as 30 s to capture both subject and background at night or under dim light. This mode is only available in programmed auto and aperture-priority auto exposure modes.

- Use of tripod is recommended to prevent blurring caused by camera shake.

CAUTION

Only available in exposure modes **P** and **A**.
 (front-curtain sync) is selected in modes **S** and **M**.

REAR Rear-curtain sync



In shutter-priority auto or manual exposure mode, flash fires just before the shutter closes, creating effect of a stream of light behind moving objects. In programmed auto and aperture-priority auto, slow rear-curtain sync is used to capture both subject and background.

- Use of tripod is recommended to prevent blurring caused by camera shake.

CAUTION

Rear-curtain sync cannot be used with studio flash systems, as the correct synchronization cannot be obtained.

MEMO

In exposure modes **P** and **A**, flash-sync mode will be set to  **SLOW REAR** (slow rear-curtain sync) when the  button is released.



Flash exposure compensation

Flash exposure compensation can be used to increase or reduce flash output from the level chosen by the camera's flash control system. Flash output can be increased to make the main subject appear brighter, or reduced to prevent unwanted highlights or reflections.

While pressing **Fn**, rotate the sub-command dial and confirm flash exposure compensation in the control panel or viewfinder.

Flash exposure compensation can be set to values between -3 EV (darker) and $+1$ EV (brighter) in increments of $1/3$ EV.

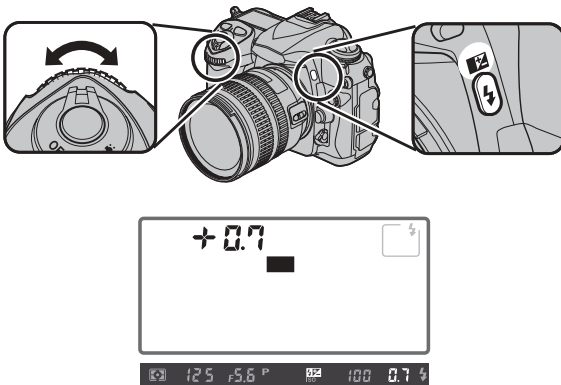

See p.78 for details of flash shooting.

- At values other than ± 0 , a **Fn** icon will be displayed in the control panel and viewfinder after you release **Fn**.
- As a rule of thumb, positive compensation may be needed when the main subject is darker than the background, negative compensation when the main subject is brighter than the background.

To release flash exposure compensation

Normal flash output can be restored by setting flash exposure compensation to ± 0.0 or performing a two-button reset. Flash exposure compensation is not reset when the camera is turned off.

MEMO

Flash exposure compensation is also available when a Nikon SB-800 or SB-600 Speedlight is attached.

FV lock

This feature is used to lock flash output, allowing photographs to be recomposed without changing the flash level. This ensures that flash output is appropriate to the subject even when the subject is not positioned in the center of the frame.

- ① Select [FV LOCK] or [FV LOCK/LENS DATA] for [FUNC. BUTTON] under [MENU] [BUTTON ASSIGNMENT] in the [SET UP] menu (→p.138, 168).
- ② Press the flash pop-up button to raise the flash.

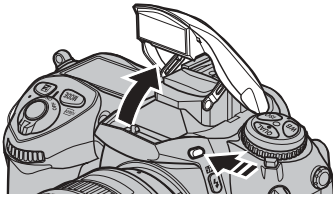

- ③ Position the subject in the center of the frame and press the shutter button halfway to focus.

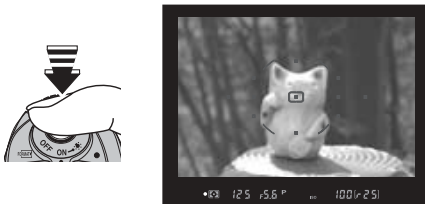

- ④ Press the FUNC. button.

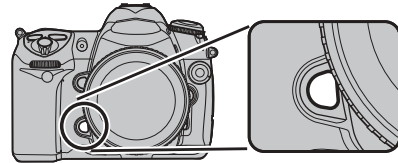

- The flash will emit a monitor preflash to determine the appropriate flash level.
 - Flash output will be locked at this level and FV lock icons (**FLASH LOCK** and **FL**) will appear in the control panel and viewfinder.
- ⑤ Move the camera to recompose the photograph, then press the shutter button fully.





If desired, additional pictures can be taken without releasing FV lock.



- ⑥ Press the FUNC. button to release FV lock and confirm that the FV lock icons (**FLASH LOCK** and **FL**) are no longer displayed in the control panel and viewfinder.

Continued ➔

■ **Using FV lock with Nikon Speedlights**

FV lock is also available with SB-800, SB-600, and SB-R200 Speedlights (available separately). In this case, set the Speedlight to TTL mode (the SB-800 can also be used in AA mode; see the Speedlight manual for details). While FV lock is in effect, flash output will automatically be adjusted for changes in Speedlight zoom head position. When the [COMMANDER MODE ] is set for the [BUILT-IN FLASH] (→p.159) under [ FLASH/BKT] in the [SET UP] menu, FV lock can be used with remote SB-800, SB-600, or SB-R200 flash units if (a) any of the built-in flash, flash group A, or flash group B is in TTL mode, or (b) a flash group is composed entirely of SB-800 Speedlights in TTL or AA mode.

■ **Using FV Lock with the built-in flash**

When the built-in flash is used alone, FV lock is only available if the [TTL : TTL MODE] is set for the [BUILT-IN FLASH] (→p.159) under [ FLASH/BKT] in the [SET UP] menu.

Lenses that can be used with the built-in flash

The built-in flash can be used with any CPU lens with a focal length of 18–300 mm. Note that the flash may be unable to light the entire subject if the following lenses are not used at or above the minimum ranges given below:

Lens	Zoom position	Minimum range
AF-S DX ED 12–24 mm f/4G	18 mm	1.5 m/4 ft. 11 in.
	20 mm	1.0 m/3 ft. 3 in.
AF-S ED 17–35 mm f/2.8D	24 mm	1.0 m/3 ft. 3 in.
AF-S DX IF ED 17–55 mm f/2.8G	24 mm	1.0 m/3 ft. 3 in.
AF ED 18–35 mm f/3.5–4.5D	18 mm	1.5 m/4 ft. 11 in.
AF-S DX VR ED 18–200 mm f/3.5–5.6G	18 mm	1.0 m/3 ft. 3 in.
AF 20–35 mm f/2.8D	20 mm	1.0 m/3 ft. 3 in.
AF-S ED 28–70 mm f/2.8D	28 mm	1.5 m/4 ft. 11 in.
	35 mm	1.0 m/3 ft. 3 in.
AF Zoom Micro Nikkor ED 70–180 mm f/4.5–5.6D	70 mm	1.0 m/3 ft. 3 in.

The built-in flash can also be used with Ai-S, Ai, and Ai-modified non-CPU lenses with a focal length of 18–200 mm. Restrictions apply to the following lenses:

- Ai 50–300 mm f/4.5, Ai-modified 50–300 mm f/4.5, and Ai-S ED 50–300 mm f/4.5: use at 135 mm and above
- Ai ED 50–300 mm f/4.5: use at 105 mm and above

Nikon Speedlights that can be used

The Nikon flash models listed in the table below can be used with this camera.

The following features are available with the SB-800, SB-600, and SB-R200:

Flash mode/feature		Speedlight	SB-800	SB-600	Advanced Wireless Lighting		
					SB-800	SB-600*1	SB-R200*2
i-TTL*3			✓*4	✓*4	✓	✓	✓
AA	Auto aperture *5		✓*6	—	✓	—	—
A	Non-TTL auto		✓*6	—	✓*7	—	—
GN	Range-priority manual		✓	—	—	—	—
M	Manual		✓	✓	✓	✓	✓
RPT	Repeating flash		✓	—	✓*9	✓*9	—
REAR	Rear-curtain sync		✓	✓	✓	✓	✓
	Red-eye reduction		✓	✓	✓	—	—
Auto FP High-Speed Sync*8			✓	✓	✓*9	✓*9	✓*9
FV lock			✓	✓	✓	✓	✓
AF-assist for multi-area AF*10			✓*5	✓*5	—	—	—
Auto zoom			✓	✓	—	—	—
ISO Auto			✓	✓	—	—	—

*1 Functions as remote flash only.

*2 Cannot be mounted on camera accessory shoe. Can be used as remote flash if camera is in commander mode (→p.159) or SB-800 Speedlight is mounted on camera and SB-R200 is controlled by Nikon SU-800 wireless Speedlight commander.

*3 When using non-CPU lens with i-TTL Balanced Fill-Flash for Digital SLR, improved precision can be obtained if lens data are specified in the [NON-CPU LENS DATA] (→p.121) under [ MISC.] in the [SET UP] menu.

*4 Standard i-TTL for Digital SLR is used with spot metering or when selected with Speedlight.

*5 Not available with non-CPU lenses unless lens data have been specified in the [NON-CPU LENS DATA] (→p.121) under [ MISC.] in the [SET UP] menu.

*6 Use Speedlight controls to select flash mode.

*7 Available only if non-CPU lens is used without specifying lens data in the [NON-CPU LENS DATA] (→p.121) under [ MISC.] in the [SET UP] menu.

*8 Select [1/250(AUTO FP)] for the [FLASH SYNC SPEED] (→p.158) under [ FLASH/BKT] in the [SET UP] menu.
Not available if built-in flash fires.

*9 Available only when SB-800 is used as master flash or Nikon SU-800 wireless Speedlight commander is used.

*10 Available with AF CPU lenses only.

The following Speedlights can be used in non-TTL auto and manual modes. If they are set to TTL, the shutter button will lock and no photographs can be taken.

Speedlight		SB-80DX, SB-28DX, SB-28, SB-26, SB-25, SB-24	SB-50DX, SB-23, SB-29*2, SB-21B*2, SB-29S*2	SB-30, SB-27*1, SB-22S, SB-22, SB-20, SB-16B, SB-15
Flash mode/feature				
A	Non-TTL auto	✓	—	✓
M	Manual	✓	✓	✓
	Repeating flash	✓	—	—
REAR	Rear-curtain sync	✓	✓	✓

*1 When an SB-27 is mounted on the IS Pro, the flash mode is automatically set to TTL, and the shutter-release will be disabled. Set the SB-27 to A (non-TTL auto flash).

*2 Autofocus is only available with AF-Micro lenses (60 mm, 105 mm, or 200 mm).

CAUTION

Flash attachments made by manufacturers other than Nikon

Use only Nikon Speedlights. Negative voltages or voltages over 250 V applied to the accessory shoe could not only prevent normal operation, but damage the sync circuitry of the camera or flash.

Continued ➔

Notes on using Nikon Speedlights

- Refer to the Speedlight manual for detailed instructions. If the Speedlight supports the Creative Lighting System, refer to the section on CLS-compatible Digital SLR cameras. The IS Pro is not included in the “Digital SLR” category in the SB-80DX, SB-28DX, and SB-50DX manuals.
- If auto FP high-speed sync is not used, the shutter will synchronize with an external flash at speeds of 1/250s or slower.
- i-TTL flash control can be used at ISO sensitivities between 100 and 1600. At values over 1600, the desired results may not be achieved at some ranges or aperture settings. If the flash-ready indicator  blinks for about three seconds after a photograph is taken, the flash has fired at full power and the photograph may be underexposed.
- When an SB-800 or SB-600 is attached, AF-assist illumination and red-eye reduction are performed by the optional Speedlight. The camera provides AF-assist illumination when other Speedlights are used (→p.64-65).
- Auto power zoom is available only with SB-800 and SB-600 Speedlights.

- In programmed auto, the maximum aperture (minimum f/-number) is limited according to sensitivity (ISO equivalency), as shown below:

100	125	160	200	250	320	400
4	4.2	4.5	4.8	5	5.3	5.6

500	640	800	1000	1250	1600
6	6.3	6.7	7.1	7.6	8

For each one-step increase in sensitivity (e.g., from 200 to 400), aperture is stopped down by half an f/-stop. If the maximum aperture of the lens is smaller than given above, the maximum value for aperture will be the maximum aperture of the lens.

- When an SC-series 17, 28, or 29 sync cable is used for off-camera flash photography, correct exposure may not be achieved in i-TTL mode. We recommend that you choose spot metering to select standard i-TTL flash control. Take a test shot and view the results in the monitor.
- In i-TTL, use the flash panel or bounce adapter provided with your Speedlight. Do not use other panels such as diffusion panels, as this may produce incorrect exposure.

ISO sensitivity (SB-800/SB-600)

When used with optional SB-800 and SB-600 Speedlights, i-TTL flash control can adjust for ISO sensitivities between 100 and 1600. It may not be able to adjust flash level appropriately for values over 1600. When [ON] is set for the [ISO AUTO CONTROL] under [ISO AUTO CONTROL] under [EXPOSURE] in the [SET UP] menu (→p.154), ISO sensitivity will automatically be adjusted as required for optimal flash output. This may result in foreground subjects being underexposed in flash photographs taken at slow shutter speeds, in daylight, or against a bright background. In these cases, choose a flash mode other than slow sync or select mode \overline{A} or \overline{M} and choose a larger aperture.

The accessory shoe

The SI Pro is equipped with an accessory shoe that allows SB-series Speedlights, including the SB-800, 600, 80DX, 50DX, 28DX, 28, 27, 23, 22S, and 29S to be mounted directly on the camera without a sync cable. The accessory shoe is equipped with a safety lock for Speedlights with a locking pin, such as the SB-800 and SB-600.

! CAUTION

Attach the accessory shoe cover when no external flash is attached on the accessory shoe.

The sync terminal

A sync cable can be connected to the sync terminal as required. Do not connect another Speedlight via a sync cable when performing rear-curtain sync flash photography with an SB-series Speedlights such as the 800, 600, 80DX, 28DX, 28, 50DX, 27, 23, 22s, or 29s mounted on the camera accessory shoe.

! CAUTION

Attach the accessory shoe cover when no external flash is attached on the accessory shoe.

Changing the Sensitivity Setting (ISO)

ISO sensitivity is the digital equivalent of film speed. The higher the ISO sensitivity, the less light needed to make an exposure, allowing higher shutter speeds or smaller apertures.

ISO sensitivity can be set between values roughly equivalent to ISO 100 and ISO 3200 in steps equivalent to 1/3 EV.

Available settings for the ISO sensitivity

100/125/160/200/250/320/400/500/640/800/1000/1250/1600/2000/2500/3200

Setting the ISO sensitivity in the [SHOOTING MENU]

Select the desired sensitivity for the [ISO] under [SHOOTING MENU].

See “Setting the [SHOOTING MENU]” (→p.108).

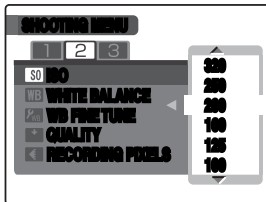

MEMO

When high ISO sensitivity is used for shooting, and [D-RANGE] is set 130% or higher, S-Pixel will be used for the shooting. And the volume of the image data (including RAW image data) will be cut to approximately half. However you can still set the dynamic-range to up to 400% for use with applications.

Setting the ISO sensitivity using ISO and the main-command dial

While pressing ISO, rotate the main-command dial until the desired setting is displayed in the control panel or viewfinder.

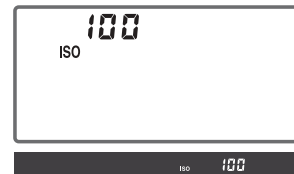
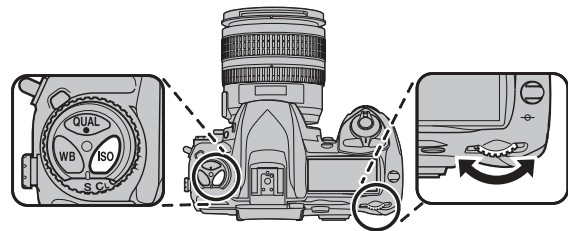

CAUTION

Images shot in high-sensitivity photography may appear coarse and may also be affected by noise such as white dots.

Changing the Image Quality Setting (QUALITY)

The camera supports the following image quality options (listed in descending order by image quality and file size):

Available settings for the image quality

RAW	Recorded as uncompressed CCD-RAW data. No image processing is performed on the camera. Select this setting when you want to process the image on a PC.
FINE JPG	Records JPEG images in high quality (low compression ratio). This mode allows you to record more images than the [RAW] setting.
NORMAL JPG	Records JPEG images in standard quality (standard compression ratio). Allows you to record the largest number of images.
RAW+ FINE JPG	Two images are recorded: one RAW image and one FINE JPEG image.
RAW+ NORMAL JPG	Two images are recorded: one RAW image and one NORMAL JPEG image.

CAUTION

- When photographs taken at [RAW+FINE JPG] or [RAW+NORMAL JPG] are viewed on the camera, only the JPEG image will be displayed.
- When photographs taken at [RAW+FINE JPG] or [RAW+NORMAL JPG] settings are deleted, both RAW and JPEG images will be deleted.
- The camera will be able to record TIFF-RGB formatted images by firmware upgrades, which will become available in the future.
See our web site for details about upgrading firmware.
<http://www.fujifilm.com/products/digital/download/ispro/fupd.html>

Setting the image quality in the [SHOOTING MENU]

Select the desired quality in the [QUALITY] under [SHOOTING MENU].

See “Setting the [SHOOTING MENU]” (→p.108).

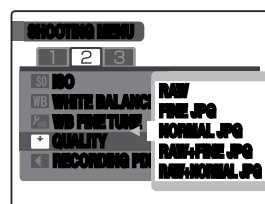

Setting the image quality using QUAL and the main-command dial

While pressing QUAL, rotate the main-command dial until the desired setting is displayed in the control panel.

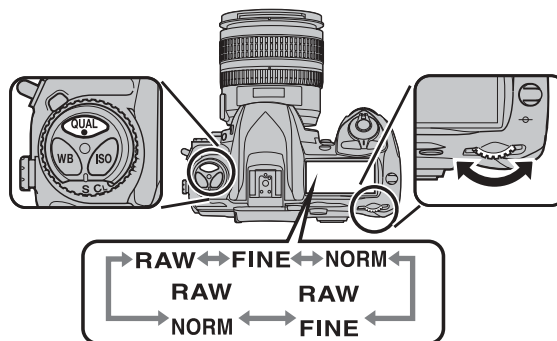

Changing the Image Size Setting (◀ RECORDING PIXELS)

Sets the size of the photographed image.

Available settings for the image size

L 4256×2848:

Sets the image size to 4256 × 2848 pixels (approx. 12.1 megapixels). You can record the fewest number of images in this mode.

M 3024×2016:

Sets the image size to 3024 × 2016 pixels (approx. 6.1 megapixels).

S 2304×1536:

Sets the image size to 2304 × 1536 pixels (approx. 3.54 megapixels). You can record the largest number of images in this mode.

Guide to printed image sizes

L 4256×2848	Printing at up to 35.6 × 43.2 cm (14 × 17 in.) / A3 size
M 3024×2016	Printing at up to 10R (25.4 × 30.5 cm/10 × 12 in.) / A4 size
S 2304×1536	Printing at up to 6R (15.2 × 20.3 cm/6 × 8 in.) / A5 size

Setting the image size in the [SHOOTING MENU]

Select the desired image size for the [RECORDING PIXELS] under [SHOOTING MENU].

See “Setting the [SHOOTING MENU]” (→p.108).

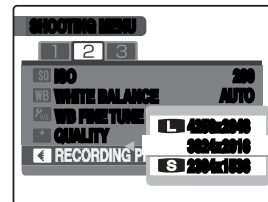

Setting the image size using QUAL and the sub-command dial

While pressing QUAL, rotate the sub-command dial until the desired setting is displayed in the control panel.

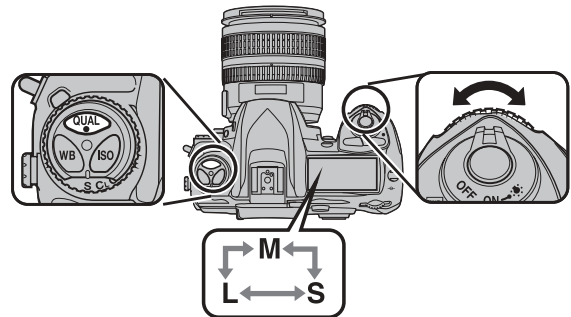

Adjusting Color Balance (**WB** WHITE BALANCE)

Change the settings when you want to set the white balance to suit the natural or artificial lighting conditions when you shoot.

When [AUTO] is selected, the correct white balance sometimes cannot be obtained under special light sources or for subjects where people's faces are highlighted, etc. In such cases, select the correct white balance setting for the light source.

■ Available settings for the white balance

A AUTO

The camera automatically determines the amount of light and the color information for the shot and takes the picture with a natural white balance. For best results, use type G or D lens.

☼ INCANDESCENT

Select this setting for shots when the light source is incandescent bulbs or lights.

☼₁ FLUORESCENT LAMP-1

Select this setting for shots taken under "Daylight" fluorescent lamps.

☼₂ FLUORESCENT LAMP-2

Select this setting for shots taken under "Daylight White" fluorescent lamps.

☼₃ FLUORESCENT LAMP-3

Select this setting for shots taken under "Cool White" fluorescent lamps.

☼₄ FLUORESCENT LAMP-4

Select this setting for shots taken under "Warm White" fluorescent lamps.

☼₅ FLUORESCENT LAMP-5

Select this setting for shots taken under "Living Room Warm White" fluorescent lamps.

☼ FINE

Select this setting for outdoor shots in fine weather when the light source for the shot is the sun.

⚡ FLASH

Use with built-in flash or Nikon flash units.

☼ SHADE

Select this setting for shots taken in shade or on cloudy days.

☼ CHOOSE COLOR TEMP.

Choose color temperature from list of values (→p.97).

☼ PRESET CUSTOM 1-5

The photographer can set the white balance based on the subject of light source. Use gray or white object as reference for the setting white balance.

📄 MEMO

- Auto white balance is recommended with most light sources. If the desired results cannot be achieved with auto white balance, choose an option from the list above. Also, use **WB** WB FINE TUNE or Preset White Balance.
- Auto white balance may not produce the desired results with studio strobe lighting. Choose a color temperature, use preset white balance, or set white balance to flash and use fine tuning to adjust white balance.
- When using settings other than **☼** CHOOSE COLOR TEMP. and **☼** PRESET CUSTOM 1-5, use the built-in flash or Nikon SB-800 and SB-600 Speedlights to produce appropriate white balance at the flash firing.

Continued ➔

Adjusting Color Balance (WB WHITE BALANCE)

■ Setting the color balance in the [SHOOTING MENU]

Select the desired setting for [WB WHITE BALANCE] under [SHOOTING MENU]. See “Setting the [SHOOTING MENU]” (→p.108).

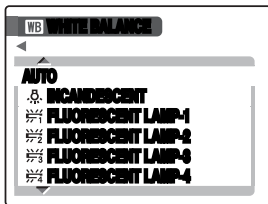



MEMO

When [OK] is selected for the [PRESET CUSTOM], preset white balance is applied. If the preset white balance is not yet set, select [NEW WB], then set the white balance to be applied (→p.99).

■ Setting the color balance using WB and the command dials

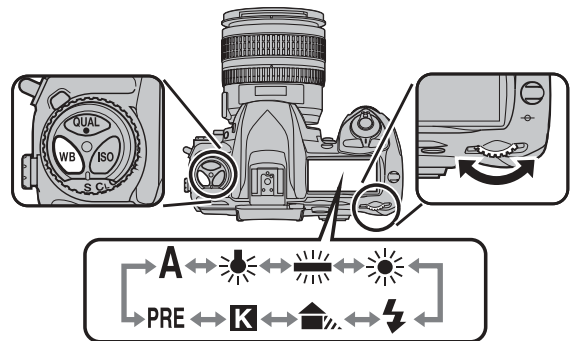

- ① While pressing WB, rotate the main-command dial until the desired setting is displayed in the control panel.

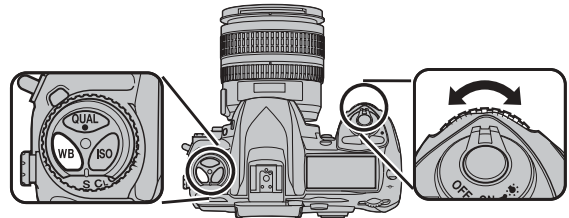

- ② While pressing WB, rotate the sub-command dial to select the number when  or PRE is selected for ① step.



K CHOOSE COLOR TEMP.

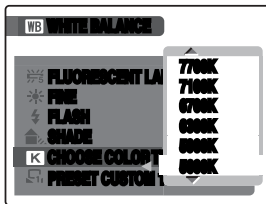

For taking a picture in daylight without flash or artificial light, such as taking a landscape, you can specify color temperature to set white balance. When **K** CHOOSE COLOR TEMP. is selected for the white balance setting, you can specify color temperature by specifying a numeric value. When taking a picture with flash or fluorescent light, select  FLASH mode or  FLUORESCENT mode respectively.

■ Setting the color temperature in the [SHOOTING MENU]



- ① Select the [**K** CHOOSE COLOR TEMP.] under [**WB** WHITE BALANCE] in the [SHOOTING MENU]. See “Setting the [SHOOTING MENU]” (→p.108).



- ② Press  or  to select the desired color temperature.



- ③ Press MENU/OK.

■ Setting the color temperature using WB and the command dials

- ① While pressing WB, rotate the main-command dial until **K** is displayed in the control panel.
- ② While pressing WB, rotate the sub-command dial until the desired value is displayed.

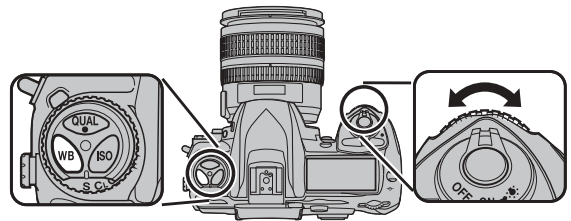

MEMO

- The camera may not produce the desired white balance, even when the numeric value measured by an external color temperature meter is applied on the camera. Take a test shot to determine if the selected value is appropriate to the light source.

Adjusting Color Balance (WB WHITE BALANCE)

WB FINE TUNE

The white balance can be fine tuned within a range of between +3 and -3, in 1-step increments .

[AWB/PRE.WB]

Fine tune all white balances except PRE CUS in single operation.

[PRE CUS.1] – [PRE CUS.5]

Fine tune the white balance for each PRE CUS settings.

■ Fine tuning in the [SHOOTING MENU]

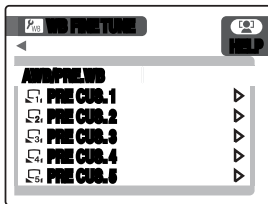

- 1 Select the [ WB FINE TUNE] under [SHOOTING MENU].

See “Setting the [SHOOTING MENU]” (→p.108).



- 2 Press ▲ or ▼ to select the item to fine tune.



- 3 Press ►.

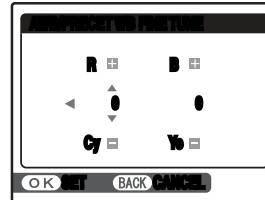

R(RED)-Cy: Enhances the redness of an image when the value is +, the cyan of an image when the value is -.

B(Blue)-Ye: Enhances the blue of an image when the value is +, the yellow of an image when the value is -.

Enhances the magenta of an image when both R-Cy and B-Ye values are +, the green of an image when -.



- 4 Press ▲, ▼, ►, or ◀ to set the desired fine tuning value between -3 and +3.



- 5 Press MENU/OK.

! CAUTION

The setting for fine tuning white balance will not be reset when the shooting menu is reset, or the camera is turned off.

Preset White Balance

Use this function to set the correct white balance for a light source. You can also use this function to achieve a desired special effect.

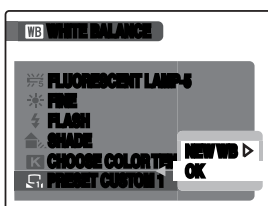

Setting the preset white balance in the [SHOOTING MENU]

- 1 Set the focus-mode selector to **M** (manual).



- 2 Select one of the  PRESET CUSTOM items under [WB] WHITE BALANCE in the [SHOOTING MENU]. See “Setting the [SHOOTING MENU]” (→p.108).



- 3 Press  or  to select [NEW WB].



- 4 Press .

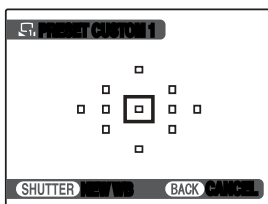

- 5 Hold up a sheet of white paper, reflectivity of 18% grey card, etc., under the target light source. Be sure the white balance reference object fills the 8-mm (0.31-in.) reference circle for center-weighted metering in the viewfinder (→p.19). Then press the shutter button.

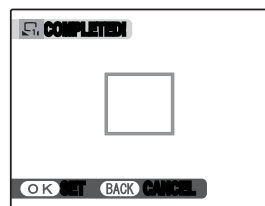

- 6 If the exposure is measured correctly, “COMPLETED!” appears on the LCD monitor.



Check that the white balance reference object fills the  area on the LCD monitor. Press MENU/OK to confirm the setting.

When the exposure is not measured correctly

OVER: The subject is too bright. Use a negative (–) exposure compensation value and set the white balance again.

UNDER: The subject is too dark. Use a positive (+) exposure compensation value and set the white balance again.

Continued 

Adjusting Color Balance (WB WHITE BALANCE)

■ Setting the preset white balance using WB and the command dials

- ① While pressing WB, rotate the main-command dial until **PRE** (preset) is displayed in the control panel.
- ② While pressing WB, rotate the sub-command dial to select a preset custom number (P-1 to P-5).

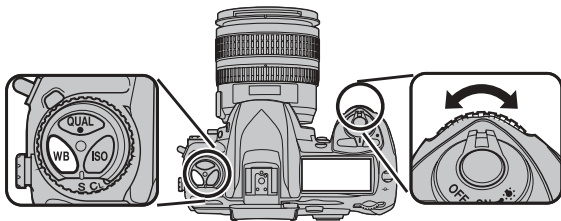

- ③ Remove your finger from WB and press again for more than 1.5 seconds. Preset recording mode is activated and **PrE** flashes in the viewfinder and the control panel. Also, the preset custom number and **PRE** flash in the control panel.

WB

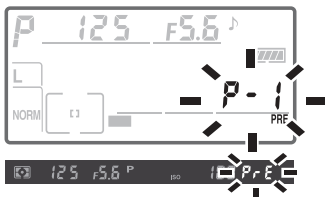

- ④ Hold up a sheet of white paper, reflectivity of 18% grey card, etc., under the target light source. Be sure the white balance reference object fills the 8-mm (0.31-in.) reference circle for center-weighted metering in the viewfinder (→p.19). Then press the shutter button.



- ⑤ If the exposure is measured correctly, **Good** blinks in the shutter speed display in the control panel, and **Ed** blinks in the shutter speed display in the viewfinder for about 3 seconds. Then preset recording mode ends.



■ When the exposure is not measured correctly

When the exposure is not measured correctly, **noEd** blinks in the shutter speed display in the control panel (exposure display in the viewfinder) for about 3 seconds, then returns to the ③ step.

📄 MEMO

- The preset white balance cannot be set if:
 - the memory card is full.
 - the memory card has an error.
 - **FE E** is flashing.
 - the frame number has reached 999-9999.
 - **bulb** is set in exposure mode **S**.
- Setting the preset white balance again is recommended when the ISO sensitivity is changed.

Self-Timer Mode

You can use the self-timer when you want to be in the photograph. Use a tripod or place the camera on a stable surface before using the self-timer.

■ Available settings for the self-timer

2 SEC/5 SEC/10 SEC/20 SEC

- 1 Select the desired time for the [SELF-TIMER] under [SHOOTING] in the [SET UP] menu.

See “Using the [SET UP] menu” (→p.138).

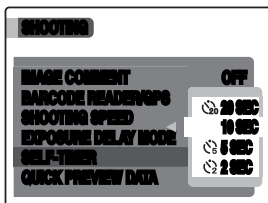

- 2 While pressing the release mode dial unlock button, rotate the release mode dial to select  (self-timer mode).

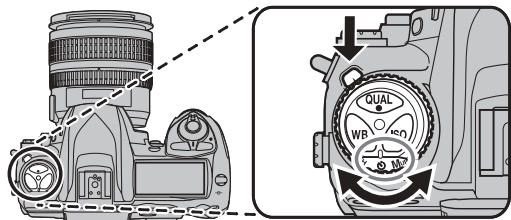

- 3 Press the shutter button down halfway to focus on the subject and press the shutter button fully.

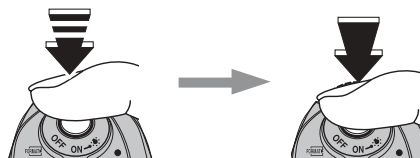

MEMO

In single-servo AF (→p.54), photographs can only be taken if the in-focus indicator (●) appears in the viewfinder.

Continued →

4 The picture is taken in the selected time.

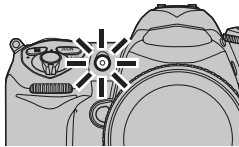

- The self-timer lamp (AF-assist illuminator) will start to blink and a beep will begin to sound.
- Two seconds before the photograph is taken, the self-timer lamp will stop blinking and the beeping will become more rapid.
- The self-timer will be cancelled if the built-in flash is raised before the picture is taken. To start the timer after raising the flash, wait until the flash-ready indicator is displayed in the viewfinder and then press the shutter button.

MEMO

- In exposure modes other than manual, remove the viewfinder eyepiece cup and insert the supplied eyepiece cap as shown. This prevents light entering via the viewfinder from interfering with exposure.

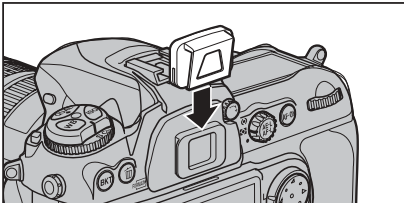

- In self-timer mode, a shutter speed of $\frac{1}{3}$ is equivalent to approximately 1/3 s.

To cancel the self-timer

To turn the self-timer off before a photograph is taken, hold down the release mode dial unlock button and turn the release mode dial to another setting.

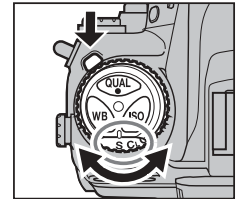

Using Auto Bracketing

The camera provides two types of auto bracketing. In exposure bracketing, the camera varies exposure compensation with each shot. In flash bracketing, flash level is varied for each shot.

Available auto bracketing settings

Exposure and Flash Bracketing ([AE & FLASH])

Performs both AE bracketing and flash bracketing at the same time.

Exposure Bracketing ([AE ONLY])

When AE bracketing is set and each time the shutter button is pressed, the preset number of frames (maximum 9 shots) is shot while the exposure automatically changes according to the exposure increment setting (measured from the original exposure displayed by the camera). You can set in any exposure mode (programmed auto, manual, etc.), however the compensation (shutter speed/exposure) varies for each. The maximum step value is $\pm 4\text{EV}$, excluding exposure compensation.

Flash Bracketing ([FLASH ONLY])

When flash bracketing is set and each time the shutter button is pressed, the preset number of frames (maximum 9 frames) is shot while the flash level automatically changes. The maximum step value is $\pm 4\text{EV}$, excluding flash compensation. The flash bracketing can be performed only when i-TTL mode or auto aperture (Nikon Speedlight SB-800 only) is set.

- 1 Select the desired setting for [AUTO BRACKETING SET] under [FLASH/BKT] in the [SET UP] menu.

See “Using the [SET UP] menu” (→p.138).

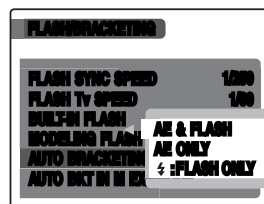

- 2 While pressing BKT, rotate the main-command dial to choose the number of shots in the bracketing sequence (→p.106).

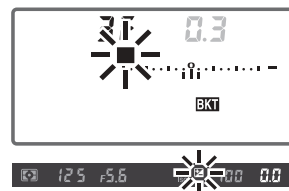
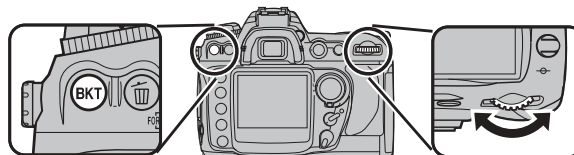

At settings other than zero, a **BKT** icon and bracketing indicator will be displayed in the control panel and the  icon will blink in the control panel and viewfinder.

Continued ➔

3 While pressing **BKT**, rotate the sub-command dial to choose the exposure increment (→p.106).

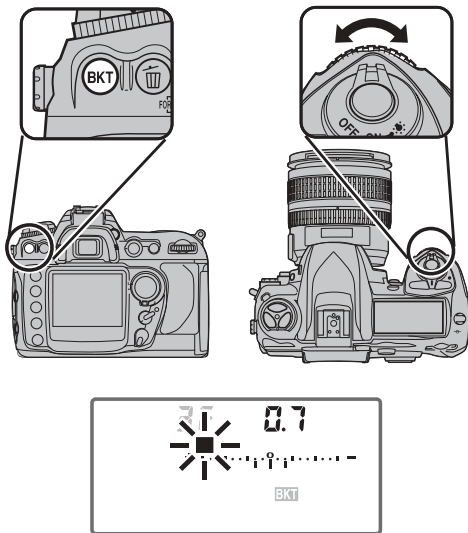

4 Frame a photograph, focus, and shoot.

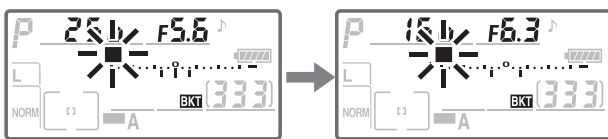

- While bracketing is in effect, a bracketing progress indicator will be displayed in the control panel. A segment will disappear from the indicator after each shot.

- Modifications to exposure are added to those made with exposure compensation, making it possible to achieve exposure compensation values of more than 5 EV.

To cancel bracketing

To cancel bracketing, hold down **BKT** and rotate the main-command dial until the number of shots in the bracketing sequence is zero and **BKT** is no longer displayed in the control panel. The program last in effect will be restored the next time bracketing is activated. Bracketing can also be cancelled by performing a two-button reset (→p.120). In this case also, the bracketing program will be restored the next time bracketing is activated.

■ Exposure Bracketing

The camera modifies exposure by varying shutter speed and aperture (programmed auto), aperture (shutter-priority auto), or shutter speed (aperture-priority auto, manual exposure mode).

P:shutter speed and aperture *1

S:aperture*1

A:shutter speed*1

M:shutter speed*2

*1 When [ON] is selected for the [ISO AUTO CONTROL] under [ISO AUTO CONTROL] under [EXPOSURE] in the [SET UP] menu, the camera will automatically vary ISO sensitivity for optimum exposure when the limits of the camera exposure system are exceeded.

*2 Can be modified by the [AUTO BKT IN M EXP.MODE] under [FLASH/BKET] in the [SET UP] menu (→p.165).



MEMO

- In single frame and self-timer modes, one shot will be taken each time the shutter button is pressed. In continuous low speed and continuous high speed modes, shooting will pause after the number of shots specified in the bracketing program have been taken. Shooting will resume the next time the shutter button is pressed.
- If the memory card fills before all shots in the sequence have been taken, shooting can be resumed from the next shot in the sequence after the memory card has been replaced or shots have been deleted to make room on the memory card. If the camera is turned off before all shots in the sequence have been taken, bracketing will resume from the next shot in the sequence when the camera is turned on.

Continued ➔

■ Bracketing Programs

The programs available when [AE & FLASH], [AE ONLY] or [⚡: FLASH ONLY] is selected for [AUTO BRACKETING SET] under [⚡ FLASH/BKT] in the [SET UP] menu depend on the option selected for [EV CONTROL STEPS].

1/3 Step Selected for EV Step

Control panel display	No. of shots	Exposure increment	Bracketing order (EVs)
+3F 0.3	3	+1/3	+0.3, 0, +0.7
+3F 0.7	3	+2/3	+0.7, 0, +1.3
+3F 1.0	3	+1	1.0, 0, 2.0
--3F 0.3	3	-1/3	-0.3, -0.7, 0
--3F 0.7	3	-2/3	-0.7, -1.3, 0
--3F 1.0	3	-1	-1.0, -2.0, 0
+2F 0.3	2	+1/3	0, +0.3
+2F 0.7	2	+2/3	0, +0.7
+2F 1.0	2	+1	0, +1
--2F 0.3	2	-1/3	0, -0.3
--2F 0.7	2	-2/3	0, -0.7
--2F 1.0	2	-1	0, -1
3F 0.3	3	±1/3	0, -0.3, +0.3
3F 0.7	3	±2/3	0, -0.7, +0.7
3F 1.0	3	±1	0, -1, +1
5F 0.3	5	±1/3	0, -0.7, -0.3, +0.3, +0.7
5F 0.7	5	±2/3	0, -1.3, -0.7, +0.7, +1.3
5F 1.0	5	±1	0, -2.0, -1, +1, +2.0
7F 0.3	7	±1/3	0, -1.0, -0.7, -0.3, +0.3, +0.7, +1.0
7F 0.7	7	±2/3	0, -2.0, -1.3, -0.7, +0.7, +1.3, +2.0
7F 1.0	7	±1	0, 3.0, -2.0, -1.0, +1.0, +2.0, +3.0
9F 0.3	9	±1/3	0, -1.3, -1.0, -0.7, -0.3, +0.3, +0.7, +1.0, +1.3
9F 0.7	9	±2/3	0, -2.7, -2.0, -1.3, -0.7, +0.7, +1.3, +2.0, +2.7
9F 1.0	9	±1	0, -4.0, -3.0, -2.0, -1.0, +1.0, +2.0, +3.0, +4.0

1/2 Step Selected for EV Step

Control panel display	No. of shots	Exposure increment	Bracketing order (EVs)
+ 3F 0.5	3	+1/2	+0.5, 0, +1.0
+ 3F 1.0	3	+1	1.0, 0, 2.0
-- 3F 0.5	3	-1/2	-0.5, -1.0, 0
-- 3F 1.0	3	-1	-1.0, -2.0, 0
+ 2F 0.5	2	+1/2	0, +0.5
+ 2F 1.0	2	+1	0, +1
-- 2F 0.5	2	-1/2	0, -0.5
-- 2F 1.0	2	-1	0, -1
3F 0.5	3	±1/2	0, -0.5, +0.5
3F 1.0	3	±1	0, -1, +1
5F 0.5	5	±1/2	0, -1.0, -0.5, +0.5, +1.0
5F 1.0	5	±1	0, -2.0, -1, +1, +2.0
7F 0.5	7	±1/2	0, -1.5, -1.0, 0.5, +0.5, +1.0, +1.5
7F 1.0	7	±1	0, -3.0, -2.0, -1.0, +1.0, +2.0, +3.0
9F 0.5	9	±1/2	0, -2.0, -1.5, -1.0, -0.5, +0.5, +1.0, +1.5, +2.0
9F 1.0	9	±1	0, -4.0, -3.0, -2.0, -1.0, +1.0, +2.0, +3.0, +4.0

1 Step Selected for EV Step

Control panel display	No. of shots	Exposure increment	Bracketing order (EVs)
+ 3F 1.0	3	+1	1.0, 0, 2.0
-- 3F 1.0	3	-1	-1.0, -2.0, 0
+ 2F 1.0	2	+1	0, +1
-- 2F 1.0	2	-1	0, -1
3F 1.0	3	±1	0, -1, +1
5F 1.0	5	±1	0, -2.0, -1, +1, +2.0
7F 1.0	7	±1	0, -3.0, -2.0, -1.0, +1.0, +2.0, +3.0
9F 1.0	9	±1	0, -4.0, -3.0, -2.0, -1.0, +1.0, +2.0, +3.0, +4.0

Using SHOOTING MENU

Use these menus to adjust image quality or focus. You can take pictures in a wide range of conditions.

Setting the [SHOOTING MENU]

1 Display the [SHOOTING MENU].

- 1 Set the camera to shooting mode. If the playback mode is active, press the shutter button halfway.



- 2 Press MENU/OK to open the [SHOOTING MENU].

2 Select the item.

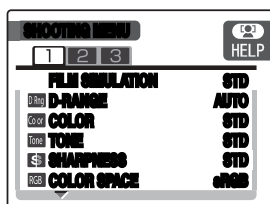

- 1 Press ▲ or ▼ to select the item.

3 Change the setting.

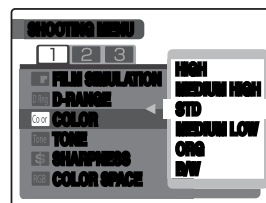

- 1 Press ►. Different type of screen appears depending on selected item.



- 2 Press ▲ or ▼ to change the setting.























- 3 Press MENU/OK to confirm the setting.

Help on the menu screen









Help is available when the HELP mark is displayed in the upper right of the screen while selecting items in menus. Press and hold the for a description of the selected item.



List of [SHOOTING MENU] options

Menu	Functions	Settings
 FILM SIMULATION (→p.111)	Sets the image formation parameters for images. You can select from Standard (STANDARD), Studio Portrait (F1, F1a, F1b, F1c), or Fujichrome (F2).	STANDARD* /  F1 /  F1a /  F1b /  F1c /  F2
 D-RANGE (→p.112)	Sets the dynamic range of images.	AUTO* / 100%(STD) / 130% / 170% / 230%(W1) / 300% / 400%(W2)
 COLOR (→p.113)	Sets the density of the color of images.	HIGH / MEDIUM HIGH / STD* / MEDIUM LOW / ORG / B/W
 TONE (→p.113)	Sets the contrast of images.	HARD / MEDIUM HARD / STD* / MEDIUM SOFT / ORG
 SHARPNESS (→p.114)	Softens or sharpens the outlines in an image and to adjust the quality of the images.	HARD / MEDIUM HARD / STD* / MEDIUM SOFT / OFF
 COLOR SPACE (→p.114)	Sets the color space to sRGB or Adobe RGB (1998).	sRGB* / Adobe RGB (1998)
 ISO (→p.92)	Specifies light sensitivity. The higher the value, the higher the sensitivity obtained. Higher sensitivity settings will allow you to take pictures in darker locations.	100 / 125 / 160 / 200* / 250 / 320 / 400 / 500 / 640 / 800 / 1000 / 1250 / 1600 / 2000 / 2500 / 3200
 WHITE BALANCE (→p.95)	Adjusts the color balance to suit the color of the ambient light around the subject.	AUTO* /  INCANDESCENT /  FLUORESCENT LAMP 1-5 /  FINE /  FLASH /  SHADE /  CHOOSE COLOR TEMP. /  PRESET CUSTOM 1-5
 WB FINE TUNE (→p.98)	Fine tunes white balance.	-3 / -2 / -1 / 0* / +1 / +2 / +3

* Factory default

Menu	Functions	Settings
 QUALITY (→p.93)	Sets the quality of images.	RAW / FINE / NORMAL JPG* / RAW+FINE JPG / RAW+NORMAL JPG
 RECORDING PIXELS (→p.94)	Sets the size of images.	 2304x1536 /  3024x2016* /  4256x2848
 MULTIPLE EXPOSURE (→p.115)	Enables shooting multiple exposures in the same frame. Images are overlaid on top of each other.	OFF* / 2 / 3 / 4 / 5 / 6 / 7 / 8 / 9 / 10
 LIVE VIEW DISPLAY (→p.117)	Enables monitoring an image on the LCD monitor while adjusting the focus.	B&W / COLOR*
 SHOOTING MENU RESET (→p.119)	Resets the [SHOOTING MENU] to the factory default settings.	—
 NOISE REDUCTION (→p.119)	Sets the noise reduction effect.	STD* / ORG

* Factory default

SHOOTING MENU

Setting the menu (→p.108)

FILM SIMULATION

Sets the image formation parameters for photographed images.

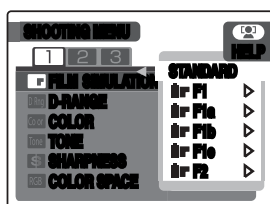

[STANDARD]

This is the standard image composition mode and is ideal for a wide range of subjects, including portraits and scenery.

[F1]

This mode suppresses flaring in flash highlights when the flash is used and also stresses smooth tonal transitions in the reproduction of skin tones. It is ideal for studio portrait work where the aim is professional-standard negatives.

[F1a]

Saturation is slightly enhanced in comparison with [F1] mode.

[F1b]

Reproduces skin tones with smooth transitions. Also provides vibrant reproduction of natural colors such as blue skies and is ideal for daylight portraits.

[F1c]

Increased sharpness in comparison with the [F1]. Ideal for fashion shooting.

[F2]

This mode provides vibrant reproduction of natural colors such as blue skies and is ideal for landscape and nature photography.

Fine tuning the film simulation

Enables fine tuning the film simulation settings other than [STANDARD].

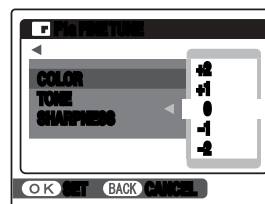

① Select the film simulation setting to be fine tuned.



② Press ► to display the screen for fine tune setting.



③ Press ▲ or ▼ to select the item.



④ Press ►.



⑤ Press ▲ or ▼ to select the fine tune value between +2 and -2.



⑥ Press MENU/OK to confirm the setting.

Continued ➔

 **MEMO**

Depending on the selected film simulation mode, the fine tune value may be displayed in gray, and will not be selectable.

 **D-Rng D-RANGE**

Sets the dynamic range used for photographed images.

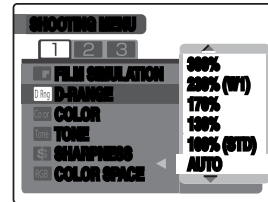

[AUTO]

The camera automatically varies the dynamic range between 100% and 400% according to the scene being shot before taking the picture. This mode suppresses white flaring and black patches in scenes with high contrast while also enabling you to achieve good levels of contrast in pictures taken indoors or in cloudy weather where a wide dynamic range is not needed.

[100%(STD)], [130%], [170%], [230%(W1)], [300%], [400%(W2)]

Takes the picture with a fixed dynamic range value, regardless of the scene being shot.

 **CAUTION**

Dynamic range can be set if [STD] is set under  FILM SIMULATION] in the [SHOOTING MENU].

 **MEMO**

When [100% (STD)] is selected, the continuous shooting interval will be faster. Also in this case, only S-pixel is used for images, and only 100% can be selected for the dynamic range settings in the software (Hyper-Utility Software HS-V3 and enclosed FinePixViewer) even for RAW images.

Color COLOR

Sets the density of the color used when shooting images.

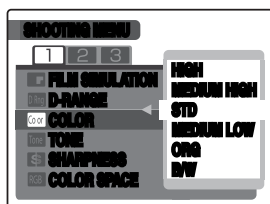

[HIGH]

This setting provides the highest color density.

[MEDIUM HIGH]

This setting provides a higher color density than [STD].

[STD]

This setting sets the standard color density.

[MEDIUM LOW]

This setting specifies a lower color density than [STD].

[ORG]

This setting specifies the lowest color density. Use this setting for images that will undergo image processing for use in commercial printing.

[B/W]

This setting converts the colors in the photographed image to black and white.

CAUTION

- Color can be set if [STD] is set under [ FILM SIMULATION] in the [SHOOTING MENU].
- If you want to view or print the image data directly, do not select [ORG].

Tone TONE

Use this setting to adjust the contrast of images to be shot.

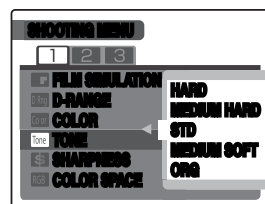

[HARD]

This setting provides the highest level of contrast.

[MEDIUM HARD]

This setting provides a higher level of contrast than [STD].

[STD]

This setting sets the contrast for photographed images to the standard level.

[MEDIUM SOFT]

This setting specifies a lower contrast than [STD].

[ORG]

This setting specifies the lowest contrast. Use this setting for images that will undergo image processing for use in commercial printing.

CAUTION

- Tone can be set if [STD] is set under [ FILM SIMULATION] in the [SHOOTING MENU].
- If you want to view or print the image data directly, do not select [ORG].

S SHARPNESS

Use this setting to soften or sharpen the outlines in an image and to adjust the quality of the photographed image.

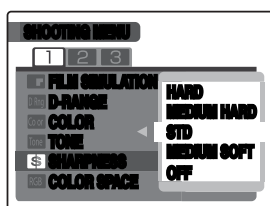

[HARD]

This setting sharpens the outlines in an image and is best for images of subjects such as buildings or text where clarity is important.

[MEDIUM HARD]

This setting sharpens the outlines more than [STD].

[STD]

This setting applies the optimum level of sharpness for normal shots.

[MEDIUM SOFT]

This setting softens the outlines more than [STD] and is best for images such as portraits.

[OFF]

Sharpness processing is not applied in this setting. Use this setting for images that will undergo image processing for use in commercial printing.

CAUTION

- Sharpness can be set if [STD] is set under [ FILM SIMULATION] in the [SHOOTING MENU].
- If you want to view or print the image data directly, do not select [OFF].

RGB COLOR SPACE

Sets the color space to either sRGB or Adobe RGB(1998).

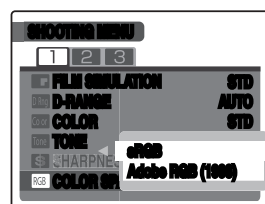

[sRGB]

For normal shooting.

[Adobe RGB (1998)]

For images that will undergo image processing (for example, for use in commercial printing).

ISO

See p.92 for details.

WHITE BALANCE

See p.95 for details.

WB FINE TUNE

See p.98 for details.

QUALITY

See p.93 for details.

RECORDING PIXELS

See p.94 for details.

MULTIPLE EXPOSURE

A series of two to ten exposures is recorded as a single photograph.

- ① Select a number of overlaying exposures for [MULTIPLE EXPOSURE] under the [SHOOTING MENU].

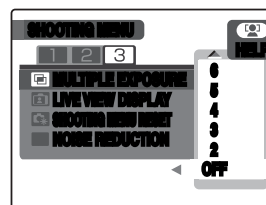

- ② Frame a photograph, focus, and shoot the first frame.



- A  icon will be displayed in the control panel.
- In the continuous high speed or continuous low speed mode the camera will record all exposures in a single burst. In the single frame shooting mode, one photograph will be taken each time the shutter button is pressed; continue shooting until all exposures have been recorded.

Continued ➔

- ③ Perform subsequent shooting.





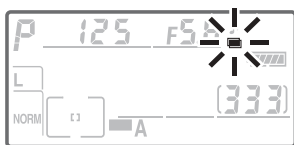

- ④ When the preset number of exposures have been shot, a single overlaid photograph is displayed.
 ⑤ Press MENU/OK to record the image (exits multiple exposure mode).





- The  icon in the control panel will disappear.

MEMO

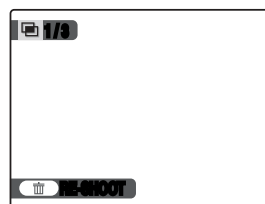
The image is displayed after the shooting. When pressing , images can be deleted and restart shooting from the beginning. The playback zoom or zoom in face functions can be performed by pressing ,  or . Press DISP/BACK to cancel the playback zoom or zoom in face function.





! CAUTION



- Do not remove or replace the memory card while recording a multiple exposure.
- The information listed in the playback photo information display (including date of recording and camera orientation) is for the first shot in multiple exposure.
- While multiple exposure mode is in effect, some of the shooting menus are limited.
- Shooting will end automatically and the shot images up to that point are recorded as an overlaid single photograph if:
 - No operation is performed for the preset time for the auto power save function.
 - The camera is turned off.
 - The battery is exhausted.
 -  is pressed.
 - SET UP is pressed.
- Dynamic range will be 400% even if [AUTO] is selected for  D-RANGE] in multiple exposure shooting.
- Multiple exposure shooting cannot be performed when ISO auto control is set to ON (in [ISO AUTO CONTROL] under [ISO AUTO CONTROL] under  EXPOSURE] in the [SET UP] menu), or auto bracketing is set.

📷 LIVE VIEW DISPLAY

To manually focus the image more sharply or to check the image, you can view the image on the LCD monitor while adjusting the focus.

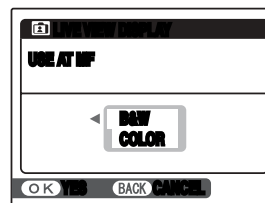
- 1 Set the focus-mode selector to  (manual). (→p.60)**
- 2 Select [ LIVE VIEW DISPLAY] under [SHOOTING MENU], or press and hold .**
- 3 Select the display color.**



- ① Press  or  to select [B&W] or [COLOR].



- ② Press MENU/OK to confirm the setting.

Continued ➔

MEMO

- Press and hold DISP/BACK to display 'black and white live view'.
- Press DIS/BACK to cancel the live view display.

4 Enlarge an image for focusing.

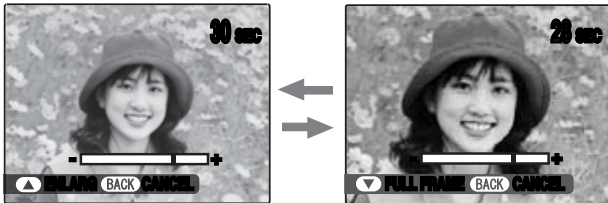

① Press ▲ or ▼ to enlarge an image.

② Focus an image manually.

MEMO

- The duration for displaying an image is 30 sec.
- Press ◀ or ▶ to change brightness.



③ Press DISP/BACK to return to normal shooting.

MEMO

- While LIVE VIEW DISPLAY is in effect, the PC connection indicator will be displayed in the control panel. This is normal.
- When turning the camera off after LIVE VIEW DISPLAY, the shutter speed may be set to $\frac{1}{125}$. Choose your desired shutter speed again.
- To view the live image, using the optional AC adapter AC-135VN is recommended.
- Continued use of live image display can cause the CCD to overheat, resulting in coarseness or noise such as white spotting in images. If this occurs, turn the camera off and wait for it to cool down before starting again.
- If you display consecutive live images, the previous brightness setting is retained for subsequent images. The setting is reset when you turn the camera off (or the auto power save function is triggered) and has to be set again.
- The live image cannot be displayed when auto bracketing is set. Cancel the auto bracketing to display the live image.

SHOOTING MENU RESET

The [SHOOTING MENU] can be reset to the factory default.

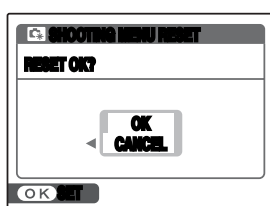

- ① Press ▲ or ▼ to select [OK].



- ② Press MENU/OK to reset [SHOOTING MENU] to the factory default.

MEMO

Resets all [SHOOTING MENU] options except [ WB FINE TUNE].

NOISE REDUCTION

Set the noise reduction effect.

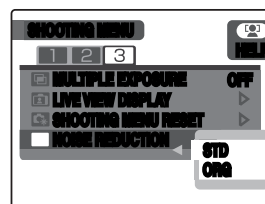

[STD]

Use this setting for most situations. The image will be clear and contain less noise.

[ORG]

This setting has a lower noise reduction effect than the [STD] setting, and provides sharpness as a priority. This setting is suitable for astronomical photography.

Two-Button Reset

The camera settings easily can be restored to the defaults. This function is convenient should you want to restore the defaults while operating the camera.

Hold  and QUAL down together for more than two seconds (these buttons are marked with a green dot). The control panel turns off briefly while the defaults are restored.

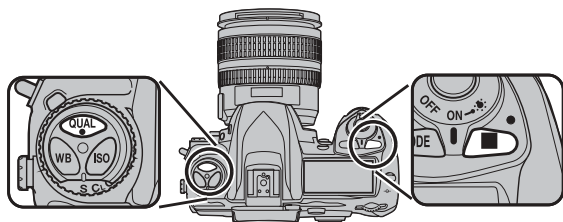

■ The settings to be reset



Focus area	Center*1
Exposure mode	 (Programed auto)
Flexible Program	Cancelled
Exposure compensation	Cancelled (0.0)
Auto Exposure Lock	Cancelled*2
Auto Exposure Bracketing	Cancelled*3
Flash Synchro mode	Front Synchro mode
Flash exposure compensation	Cancelled (0.0)
FV lock	Canceled

*1 If group dynamic-AF is set for the AF area mode, the center group will be selected.

*2 [AE/AF-L BUTTON] under [ BUTTON ASSIGNMENT] in the [SET UP] menu will not be reset.

*3 Bracketing increment is reset to 1 EV (AE and flash bracketing).

■ The [SHOOTING MENU] options to be reset

All [SHOOTING MENU] options other than [ PRESET CUSTOM 1-5] and [ WB FINE TUNE] will be reset.

MEMO

The [SET UP] menu options cannot be reset by the two-button reset.

Non-CPU Lenses

By specifying lens data (lens focal length and maximum aperture), the user can gain access to a variety of CPU lens functions when using a non-CPU lens.

If the focal length of the lens is known:

- Automatic power zoom can be used with optional Nikon SB-800 and SB-600 Speedlights.
- Lens focal length is listed (with a **[M]**) in the playback photo info display.

When the maximum aperture of the lens is known:

- The aperture value is displayed in the control panel and viewfinder.
- Flash level is adjusted for changes in aperture.
- Aperture is listed (with a **[M]**) in the playback photo info display.

Specifying both the focal length and maximum aperture of the lens:

- Enables color matrix metering (note that it may be necessary to use center-weighted or spot metering to achieve accurate results with some lenses, including Reflex-Nikkor lenses).
- Improves the precision of center-weighted and spot metering and i-TTL Balanced Fill-Flash for Digital SLR.



MEMO

The color and brightness of images may differ depending on use of CPU lens or non-CPU lens.

Specifying lens focal length

The following lens focal lengths are available.
 6, 8, 13, 15, 16, 18, 20, 24, 25, 28, 35, 43, 45, 50, 55, 58,
 70, 80, 85, 86, 100, 105, 135, 180, 200, 300, 360, 400,
 500, 600, 800, 1000, 1200, 1400, 1600, 2000, 2400,
 2800, 3200, 4000mm.

Setting the lens focal length in the [SET UP] menu.

See “Using the [SET UP] menu” (p.138)

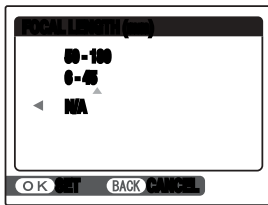

① Display the [NON-CPU LENS DATA] screen by selecting the [NON-CPU LENS DATA] under [MISC.] in the [SET UP] menu.



② Press ▲ or ▼ to select [FOCAL LENGTH (mm)].



③ Press ►.



④ Press ▲ or ▼ to select the item including the focal length of the attached lens.

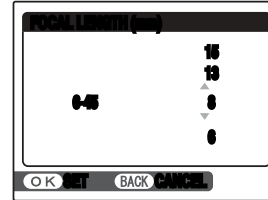

⑤ Press ►.



⑥ Press ▲ or ▼ to select the focal length of the attached lens.



⑦ Press MENU/OK to confirm the setting.

■ Setting the lens focal length using the FUNC. button and main-command dial

- ① Select [FV LOCK/LENS DATA] for [FUNC. BUTTON] under [MENU] BUTTON ASSIGNMENT in the [SET UP] menu (→p.138, 168).
- ② Choose the focal length of the attached lens by rotating the main-command dial while pressing the FUNC. button.

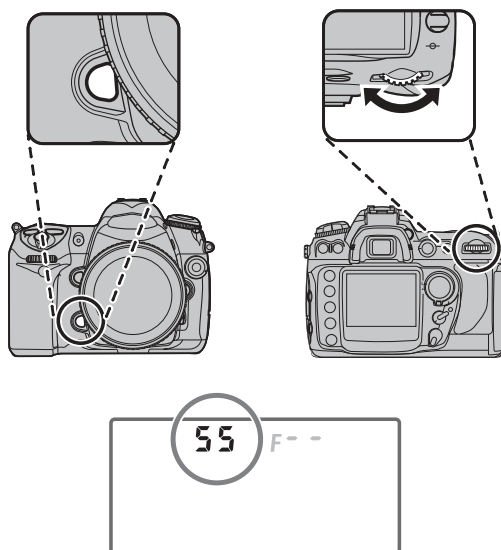

■ Specifying maximum aperture

The following f/-numbers are available:
1.2, 1.4, 1.8, 2, 2.5, 2.8, 3.3, 3.5, 4, 4.5, 5, 5.6, 6.3, 7.1, 8, 9.5, 11, 13, 15, 16, 19, 22

■ Setting the maximum aperture in the [SET UP] menu

See “Using the [SET UP] menu” (→p.138)

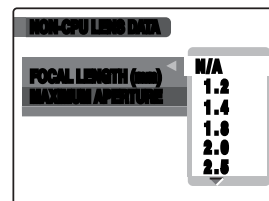

- ① Display the [NON-CPU LENS DATA] screen by selecting [NON-CPU LENS DATA] under [MISC.] in the [SET UP] menu.



- ② Press ▲ or ▼ to select [MAXIMUM APERTURE].



- ③ Press ►.



- ④ Press ▲ or ▼ to select the maximum aperture for the attached lens.



- ⑤ Press MENU/OK to confirm the setting.

Continued ➔

■ **Setting the maximum aperture using the FUNC. button and sub-command dial**

- ① Select [FV LOCK/LENS DATA] for [FUNC. BUTTON] under [MENU] BUTTON ASSIGNMENT in the [SET UP] menu (→p.168).
- ② Display the maximum aperture of attached lens by rotating the sub-command dial while pressing the FUNC. button.

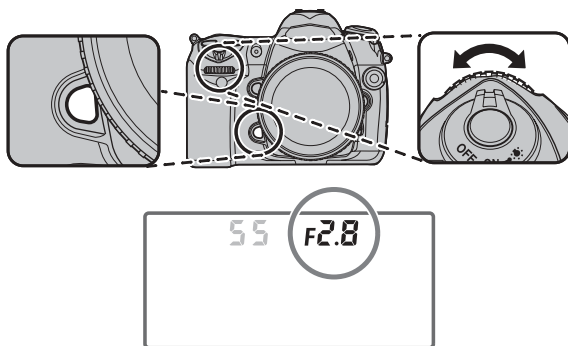

 **MEMO**

- If the built-in flash, Nikon Speedlight SB-800, or SB-600 are used, the FV lock is activated, the lens focal length cannot be set. If the built-in flash is raised, close it. If the Speedlight is attached, turn it off.
- If the correct focal length is not listed, choose the closest value greater than the actual focal length of the lens.
- Lens data is not adjusted when a non-CPU lens is zoomed in or out. After changing the zoom position, select new values for the lens focal length and maximum aperture.
- Selecting a focal length sets maximum aperture to the last value selected at that focal length.

- Set the focal length before setting the maximum aperture, otherwise the correct setting cannot be made. Set in the following order.
 - ① Set the focal length
 - ② Set the maximum aperture
- The color and white balance of images shot with a non-CPU lens may differ from those shot with a CPU lens.

Using PLAYBACK MENU

Use these menus to playback photographed images.

Setting the [PLAYBACK MENU]



- 1 Press  to set the camera to playback mode.

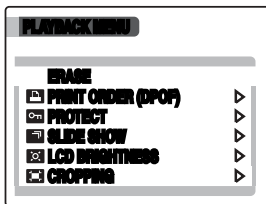

- 2 Press MENU/OK to open the [PLAYBACK MENU].





- 3 Press  or  to select the item.



- 4 Press .
Different type of screen appears depending on selected item.



- 5 Press  or  to change the setting.



- 6 Press MENU/OK to confirm the setting.

PLAYBACK MENU

Setting the menu (→p.126)

Erasing the images (ERASE)

Use this mode to erase unnecessary images to have ample free space on the memory card.

Erasing one frame at a time (FRAME)

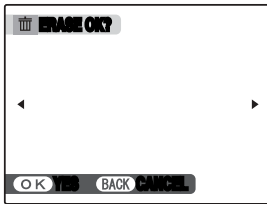

① Press ◀ or ▶ to select the erasing frame (file).



② Press MENU/OK to erase the currently displayed frame (file).

MEMO

To erase another frame (file), repeat above steps. When erasing frames (files) is completed, press DISP/BACK.

CAUTION

Pressing MENU/OK repeatedly erases consecutive frames (files). Take care not to erase a frame (file) by mistake.

Erasing all frames (ALL FRAMES)

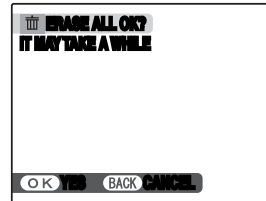

Press MENU/OK to erase all the frames (files).

MEMO

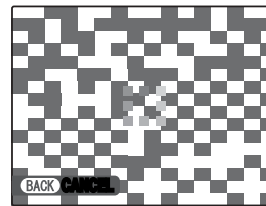

Press DISP/BACK to cancel erasing of all the frames (files). Some frames (files) not already erased may be saved.

MEMO

Protected frames (files) cannot be erased. Unprotect the frames (files) before erasing them (→p.132).

CAUTION

Erased frames (files) cannot be recovered. Back up important frames (files) onto your PC or another media.

DPOF set frame **(PRINT ORDER (DPOF))**

You can specify the image, number of prints, with or without date of printing with a DPOF-compatible printer.

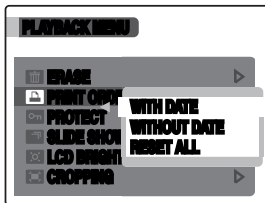

- [WITH DATE 



[WITHOUT DATE] The date will not be imprinted on your prints.

[RESET ALL] All DPOF settings will be canceled.

WITH DATE / WITHOUT DATE

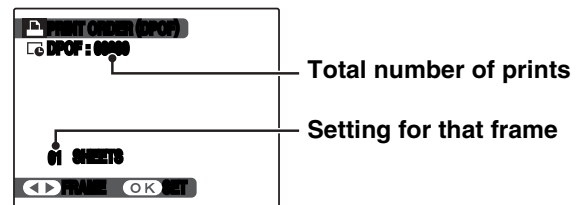
Selecting [WITH DATE  appears on the screen and the date will be imprinted on your prints.

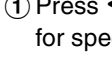

- ① Press  or  to display the frame (file) for specifying DPOF setting.
- ② Press  or  to set a value.
Select number of desired prints from 0 to 99.
For frames (files) that you do not want printed, set the number of prints to 0 (zero).

To specify more DPOF settings, repeat steps ① and ②.



- ③ Always press MENU/OK after the settings are completed.
Pressing DISP/BACK cancels those settings.



- ④ Press MENU/OK again. The total number of prints appears on the screen.

 **MEMO****To cancel DPOF setting**

- ① Press MENU/OK to open the [PLAYBACK MENU] and press ▲ or ▼ to select [PRINT ORDER (DPOF)].
- ② Press ▶.
- ③ Press ▲ or ▼ to select [WITH DATE ] or [WITHOUT DATE] and press MENU/OK to display the print order screen.
- ④ Press ◀ or ▶ to select the frame (file) with the DPOF setting you want to cancel.
- ⑤ Press ▼ to set the number of prints to 0 (zero).

To cancel the DPOF setting for another frame (file), repeat steps ④ and ⑤.

Always press MENU/OK to complete the settings.

- RESET ALL (→p.130)

 **MEMO**

- When DPOF settings were specified on another camera.

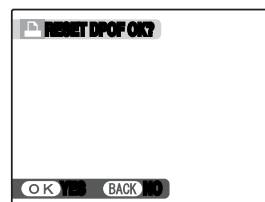

When the data includes a frame (file) with DPOF settings that were specified on another camera, [RESET DPOF OK?] appears.

Pressing MENU/OK cancels all of the DPOF settings already specified for each frame (file). Specify the DPOF setting for each frame (file) again.

- Prints of up to 999 frames (files) can be ordered on the same memory card.
- DPOF settings cannot be specified for CCD-RAW data.

 **CAUTION**

- Pressing DISP/BACK while choosing settings will cancel all current settings. If there were previous DPOF settings, only the modifications are canceled.
- When selecting the [WITH DATE ] setting, the date is imprinted on your shots using the print service or a DPOF-compatible printer (depending on the printer specifications, the date may not be printed in some cases).
- Images photographed with a camera other than IS Pro may not be specified DPOF settings.

Continued ➔

RESET ALL

To cancel all DPOF settings:

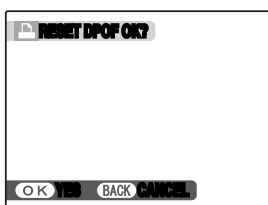



Select [RESET ALL] in the [PLAY BACK MENU] (→p.128).

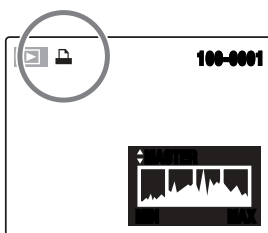

Press MENU/OK.

 **MEMO**



 appears on the screen during playback when the image has specified DPOF settings.

PRINT ORDER (DPOF)



DPOF stands for Digital Print Order Format and refers to a format that is used for recording printing specifications for images shot using a digital camera on media such as a memory card. The recorded specifications include information on which frames are to be printed.

*Some printers do not support date and time imprinting or specification of the number of prints.

*The warnings shown below may appear while specifying the prints.

“DPOF SPECIFIED. ERASE OK ?”

“DPOF SPECIFIED. ERASE ALL OK ?” (→p.127)

When erasing the image, the DPOF setting for that image is deleted at the same time.

“RESET DPOF OK ?” (→p.129)

When inserting a memory card that contains images specified for printing by another camera, those print specifications are all reset and replaced by the new print specifications.

[DPOF FILE ERROR] (→p.215)

Up to 999 images can be specified on the same memory card.

MEMO

When [ON] is set for the [QUICK PREVIEW DATA] under [ SHOOTING] in the [SET UP] menu, images may not print properly.

Protecting the images (PROTECT)

Use this mode to prevent frames (files) from being accidentally erased. Your camera calls images “frames”.

FRAME SET / RESET

To protect or unprotect only the selected frame (file):

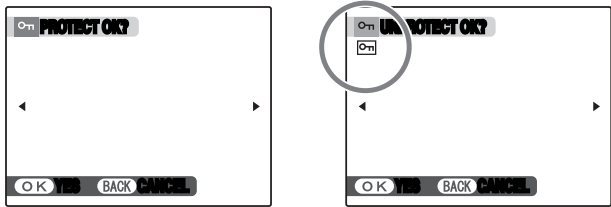

Unprotected

Protected ( displayed)



① Press ◀ or ▶ to select the protecting/unprotecting frame (file).



② Press MENU/OK to protect/unprotect the currently displayed frame (file).
Unprotected: protecting frame (file)
Protected: unprotecting frame (file)

To protect another frame (file), repeat steps ① and ②.
When protecting frames (files) is completed, press DISP/BACK.

SET ALL



Press MENU/OK to protect all the frames (files).

RESET ALL

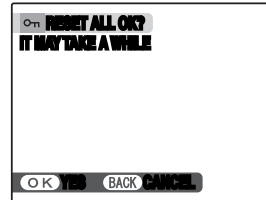

Press MENU/OK to unprotect all the frames (files).

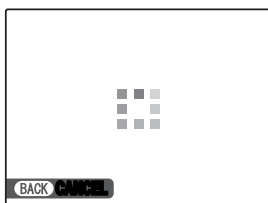
 **MEMO****To stop the procedure midway**

If the images are very large, protecting or unprotecting all the frames (files) may take some time.
If you want to take a picture during the procedure, press DISP/BACK.



 **CAUTION**

Formatting the memory card erases all the frames (files), including protected frames (files) (→p.179).

 **Setting automatic playback (▶ SLIDE SHOW)**

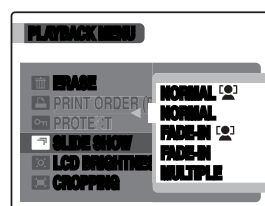
Use this mode to playback photographed images continuously. You can select type of image transition.

 **MEMO**

- To interrupt automatic playback, press MENU/OK.
- Press ◀ or ▶ to advance or go back through the images when selecting [NORMAL] and [FADE-IN].
- The auto power save function (→p.181) does not operate during playback.
- Press DISP/BACK once during playback to display on-screen help.
- Images shot by IS Pro are played back with faces zoomed in when [NORMAL ] or [FADE-IN ] is selected.

Increasing monitor brightness (LCD BRIGHTNESS)

Use this function to adjust the screen brightness.

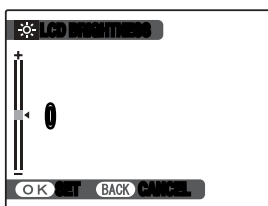

- 1 Press ▲ or ▼ to adjust the screen brightness.
The indicator moves to the + to display the screen brightly or to the – to darken the screen.



- 2 Press MENU/OK to confirm the setting.

MEMO

While checking shooting results or playing back images, the LCD monitor backlight can be brightened temporarily by pressing the center of the multi-selector.

Cropping the images (CROPPING)

Use this mode to crop the desired part of the photographed image.

1 Select the menu.



- 1 Press ◀ or ▶ to select the cropping frame (file).



- 2 Press MENU/OK to open the [PLAYBACK MENU].



- 3 Press ▲ or ▼ to select [ CROPPING].



- 4 Press ▶.

2 Specify cropping part of an image.

▼ button
(Zoom out)

▲ button
(Zoom in)

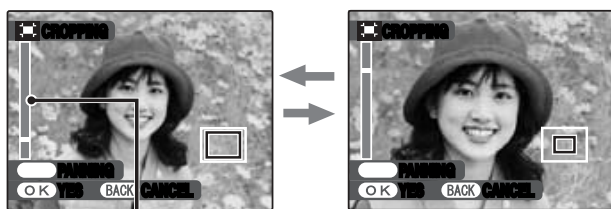

Zoom bar



① Press ▲ or ▼ to zoom in or out on an image.

MEMO

Press DISP/BACK to return to single-frame playback.



Navigation screen
(Current displayed image)



② Press ► to move to another part of the image.



③ Press ▲, ▼, ◀, or ▶ to select cropping part of the image.

MEMO

Press ► to return to the zoom setting.



④ Press MENU/OK.

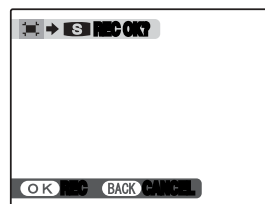

3 Record the image.

Check the saved image size and press MENU/OK.



The cropped image is added separately as the last numbered file.

MEMO

The image size after cropping is **S** 2304x1536 or **M** 3024x2016.

Continued ➔

! CAUTION

- The image cannot be cropped if:
 - The image was originally recorded with the [S 2304x1536] selected for the [RECORDING PIXELS].
 - The image was recorded with the [RAW] selected for the [QUALITY].
 - The free space of memory card is less than 3M.
- You may not be able to crop images that were shot with a camera other than IS Pro.

SET SET UP

Using the [SET UP] menu

1 Open the [SET UP] menu.

 Press SET UP to open the menu.

2 Select the category.

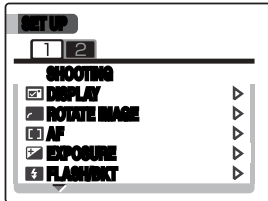



 ① Press ▲ or ▼ to select the category to change.

 ② Press ►.

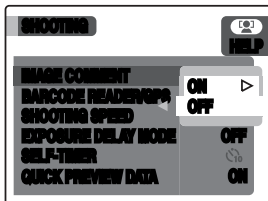
3 Change the setting.



 ① Press ▲ or ▼ to select the item.

 ② Press ►.
Different type of screen appears depending on selected item.

 ③ Press ▲ or ▼ to change the setting.

 ④ Press MENU/OK to confirm the setting.

Help on the menu screen

Help is available when the  HELP mark is displayed in the upper right of the screen while selecting items in menus. Press and hold the  for a description of the selected item.

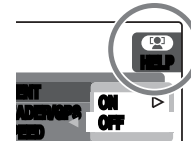

List of [SET UP] menu options

Setting	Setting (Display)	Description	Page
SHOOTING			
IMAGE COMMENT	TYPE IN/BARCODE / OFF/BARCODE* / OFF/BCD MULTI READ	User comment of up to 45 characters (EXIF) can be entered when [TYPE IN/BARCODE] is set.	146
BARCODE READER/ GPS	BCR 1 SHOT / BCR CONTINUOUS / GPS / OFF*	Stores the information of a barcode reader or GPS connected to a 10-pin terminal as Exif information.	147
SHOOTING SPEED	2 frames/s*/1 frame/s	Sets the rate at which pictures can be taken in CL (continuous low-speed) mode.	149
EXPOSURE DELAY MODE	ON / OFF*	Reduces camera shake due to mirror movement by delaying the shutter release by about 0.4 s after the mirror is raised.	149
SELF-TIMER	20 SEC / 10 SEC* / 5 SEC / 2 SEC	Used when photographer wants to be in the picture such as group photo.	101
QUICK PREVIEW DATA	ON* / OFF	Sets the speed to display images on the LCD monitor. The speed will be faster by selecting [ON]. If problems occur with playback or printing, select [OFF].	149
DISPLAY			
IMAGE DISPLAY	CONTINUOUS / 4 SEC / 2 SEC / OFF*	Specifies how to display shot images on the LCD after shooting in order to check the result.	150
ILLUMINATION	ON / OFF*	Keeps the LCD backlight active until the auto power save function is triggered.	150
GRID DISPLAY	ON / OFF*	Displays grid lines in the viewfinder to aid composition.	150
VIEWFINDER WARNING	ON* / OFF	Displays the warning icons in the viewfinder when the battery is low or no memory card is inserted.	150

* Factory default

Continued →

ROTATE IMAGE			
AUTO ROTATE PLAYBACK	ON* / OFF	Sets for displaying vertical images in portrait orientation on the LCD. Applies only to pictures taken with [ON] selected for [AUTO IMAGE ROTATION] under [ROTATE IMAGE] in the [SET UP] menu.	151
AUTO IMAGE ROTATION	ON* / OFF	Sets for recording the orientation of the camera when a picture is taken.	151
AF			
AF-C MODE PRIORITY	FPS RATE* / FPS RATE+AF / FOCUS	Controls whether photographs can be taken whenever the shutter button is pressed or only when the camera is in focus in continuous-servo AF.	152
AF-S MODE PRIORITY	R:RELEASE / F:FOCUS*	Controls whether photographs can be taken whenever the shutter button is pressed or only when the camera is in focus in single-servo AF.	152
FOCUS AREA FRAME	NORMAL (11 AREAS)* / WIDE (7 AREAS)	Sets focus frame to Normal Frame (11 Areas) or Wide Frame (7 Areas).	57
GROUP DYNAMIC AF	P1: CENTER AREA* / P1: CLOSEST SUBJECT / P2: CENTER AREA / P2: CLOSEST SUBJECT	Sets the type of focus area group and primary focus area.	152
AF LOCK-ON	LONG / NORMAL* / SHORT / OFF	Controls how autofocus adjusts to sudden large changes in the distance to the subject.	153
AF ACTIVATION	R/A:RELEASE/AF-ON* / A:AF-ON ONLY	Specifies whether autofocus activates when the shutter button is pressed halfway.	153
AF AREA ILLUMINATION	AUTO* / ON / OFF	Controls whether or not the active focus area is highlighted in red in the viewfinder.	154

* Factory default

FOCUS AREA SELECTION	WRAP / NO WRAP*	Specifies using the “wrap around” function when pressing the multi-selector in order to select the focus area.	154
BILT-IN AF-ASSIST	ON* / OFF	Sets the built-in AF-assist illuminator to light for assisting focus when the subject is poorly lit.	154
EXPOSURE			
AE LOCK	R/A:RELEASE/AE-L / A:AE-L ONLY*	Specifies how to lock exposure.	154
ISO AUTO CONTROL	ISO AUTO CONTROL / MAX.SENSITIVITY / MIN.SHUTTER SPEED	Activates the ISO auto control function when ISO sensitivity adjustment is needed for optimal exposure. The maximum ISO value can be selected. This function also can be used with the flash.	154
EV CONTROL STEPS	1/3 EV STEP* / 1/2 EV STEP / 1 EV STEP	Specifies the EV steps for exposure setting (includes shutter speed, aperture and AE bracketing).	156
EXP COMP/FINE TUNE	1/3 EV STEP* / 1/2 EV STEP / 1 EV STEP	Specifies the increment for exposure compensation and fine-tuning.	156
EASY EXPOSURE COMP.	TEMPORARY / ON / OFF*	Sets the exposure compensation adjustment by rotating the command dials without using the  .	157
CENTER-WEIGHT AREA	AVERAGE / ϕ 13mm / ϕ 10mm / ϕ 8mm* / ϕ 6mm	Sets the size of diameter for metering in the center-weighted metering mode. [AVERAGE] is the average metering value of the entire frame.	157
FINE TUNE EXPOSURE	MATRIX METERING (-1 to +1) / CENTER-WEIGHTED (-1 to +1) / SPOT METERING (-1 to +1)	Optimizes exposure by choosing a standardized level for each metering mode. This setting is not affected by two-button reset.	157

* Factory default

Continued →

⚡ FLASH/BKT			
FLASH SYNC SPEED	1/250*-1/60 1/250 (AUTO FP)	Sets the flash sync speed in the range of 1/250 s to 1/60 s.	158
FLASH Tv SPEED	1/60-30	Sets the slowest shutter speed when using the flash in exposure mode P and A .	159
BUILT-IN FLASH	TTL⚡: TTL MODE* / M⚡: MANUAL MODE / R⚡: REPEATING MODE / C⚡: COMMANDER MODE	Sets the flash control mode for the built-in flash.	159
MODELING FLASH	ON* / OFF	Specifies whether CLS (Creative Lighting System) compatible Speedlights emit a modeling flash when the preview button is pressed.	165
AUTO BRACKETING SET	AE & FLASH* / AE ONLY / ⚡: FLASH ONLY	Sets the auto bracketing setting.	165
AUTO BKT IN M EXP.MODE	⚡Tv* / ⚡Tv/Av / ⚡Av / ⚡FLASH	Specifies whether the camera varies shutter speed, aperture, and/or flash level when bracketing is activated in exposure mode M.	165
AUTO BKT ORDER	N:MTR>UNDER> OVER* / 📷: UNDER>MTR> OVER	Sets the order in which pictures are recorded in auto bracketing mode.	166
AUTO BKT SELECTION	MANUAL VALUE SELECT* / PRESET VALUE SELECT	Specifies whether to select the number of exposures and exposure increment separately, or to use a preset combination for auto bracketing.	166

* Factory default

BUTTON ASSIGNMENT			
AE-L/AF-L BUTTON	AE/AF Lock / AE LOCK ONLY* / AE LOCK HOLD/RESET / AE LOCK HOLD / AF LOCK ONLY	Specifies the function performed by the AE-L/AF-L button.	166
CENTER BUTTON	CENTER AF AREA* / ILLUMINATE AF AREA / NOT USED	Specifies the function performed by the center of the multi-selector.	167
MULTI-SELECTOR	DO NOTHING* / WAKE-UP / INITIATE AUTOFOCUS	Specifies whether the multi-selector readies the camera (wakeup) from standby status, or initiates autofocus.	167
FUNC. BUTTON	FV LOCK* / FV LOCK/ LENS DATA / 1 STEP Tv/Av / SAME AS AE-L/AF-L / FLASH OFF / BRACKETING BURST / MATRIX METERING / CENTER-WEIGHTED / SPOT METERING / FOCUS AREA FRAME	Specifies the function performed by the FUNC button.	168
FUNCTION LOCK	LOCK SETTING / FUNCTION SELECTION / CHANGE PASSWORD	Disables the command dial, [SHOOTING MENU] and [SET UP] menu in order to avoid misuse.	169
COMMAND DIALS	ROTATE DIRECTION / CHANGE MAIN/SUB / APERTURE SETTING / MENUS AND PLAYBACK	Specifies the function performed by the command dials.	172

* Factory default

Continued ➔

BUTTON AND DIAL	DEFAULT* / HOLD	Enables using the buttons and command dials together for operations.	174
TEST-SHOOTING (NO CARD)	ON* / OFF	Disables shooting an image without a memory card.	174
MISC.			
NON-CPU LENS DATA	FOCAL LENGTH (mm) / MAXIMUM APERTURE	Registers non-CPU lens data (focal length and maximum aperture) to the camera when using a non-CPU lens.	121
MB D200 BATTERY TYPE	–	Specifies the type of batteries for the MB-D200 battery pack.	175
AF-ON FOR MB-D200	–	Controls the function assigned to the AF-ON button of the optional MB-D200 battery pack.	175
FILE TAG OPTIONS	MASKING / DPI SETTING	Specifies the aspect ratio and resolution (DPI) for an image when the image is cut out (cropping) and saved.	175
MAINTENANCE			
BATTERY INFO	–	Displays the status of the rechargeable battery NP-150.	176
FIRMWARE VERSION	–	Displays the current camera firmware version.	177
MAINTENANCE COUNTER	–	Displays the number of pictures taken and the number of times the shutter unit was replaced.	177
MIRROR LOCK-UP (CLEANING)	–	Raises the mirror to allow cleaning of the low-pass filter that covers the image sensor by pressing the shutter button.	177

📷 TIME・言語/LANG.			
DATE/TIME	–	Corrects the date or time.	36
TIME DIFFERENCE	🏠 HOME / ⚡ LOCAL	Specifies the time difference settings.	177
言語/LANG.	日本語/ENGLISH/ DEUTSCH/FRANCAIS/ ESPAÑOL/ITALIANO/ 中文簡/繁體/한글	Specifies the language used for screen display.	36
⚙️ SYSTEM			
FORMAT	–	Initializes an memory card. Select this menu to erase all the frames (files).	179
USB MODE	📁 MTP (PTP)* / 📷 PC SHOOT. AUTO / 📷 PC SHOOT. FIXED	Sets the USB interface when connecting the camera to PC.	179
FRAME NO.	CONTINUOUS* / RENEW	Specifies whether frame numbers are assigned consecutively from previous numbers or begin again.	180
AUTO POWER SAVE	OFF/10 MIN / 5 MIN / 2 MIN / 1 MIN / 30 SEC / 15 SEC*	Sets the time to delay until the auto power save function operates.	181
BEEP	LOW* / HIGH / OFF	Controls the pitch of the beep that sounds when the self-timer is counting down or the camera is focusing.	181
VIDEO SYSTEM	NTSC / PAL	Specifies whether video output is set to NTSC or PAL.	181
SET-UP RESET	–	Resets all camera settings to the factory default values except [DATE/TIME] and [VIDEO SYSTEM] in the [SET UP] menu.	181

* Factory default

 **SHOOTING**

IMAGE COMMENT

User comment of up to 45 characters (EXIF) can be entered when [TYPE IN/BARCODE] is set.

[TYPE IN/BARCODE]

Manually enter or edit a comment of up to 45 characters (EXIF) by using the [INPUT COMMENT] screen (→p.147). Data read using the [OFF/BCD MULTI READ] will be erased.

The maximum number of characters is 45 when reading a barcode with the [BCR 1 SHOT] or [BCR CONTINUOUS] selected under [BARCODE READER/GPS]. In this case, the comment will be overwritten at each barcode reading.

[OFF/BARCODE]

A comment manually entered by using the [INPUT COMMENT] screen will not be recorded when [OFF/BARCODE] is set (→p.147).

The maximum number of characters is 45 when reading a barcode with the [BCR 1 SHOT] or [BCR CONTINUOUS] selected under [BARCODE READER/GPS]. In this case, the comment will be overwritten at each barcode reading.

[OFF/BCD MULTI READ]

A comment manually entered by using the [INPUT COMMENT] screen will be erased when [OFF/BCD MULTI READ] is set (→p.147).

The maximum number of characters is 248 when reading barcodes. Separate comments with comma (,) semicolon (;) or ampersand (&) when reading multiple barcodes.

■ **Manually enter a comment**

1 Activate [IMAGE COMMENT].

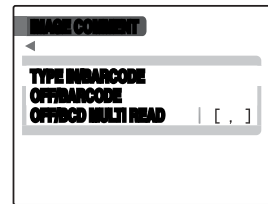

① Press ▲ or ▼ to select [TYPE IN/BARCODE].



② Press ►.



MEMO

- If [TYPE IN/BARCODE] is selected, a comment is added to all photographs taken.
- To not add a comment, select [OFF/BARCODE] or [OFF/BCD MULTI READ].

2 Enter a comment.

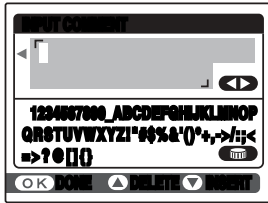

① Rotate the main-command dial to display the desired first letter to enter.



② Press ► to enter the second letter.

MEMO

- Repeat the steps ①-② to enter more letters.
- Press ◀ or ▶ to select the letter to delete, then press ▲ to delete.
- To insert a letter between other letters, press ◀ or ▶ to select the letter after the inserting position, then press ▼ to insert.

3 Exit from [IMAGE COMMENT].



Press MENU/OK.

BARCODE READER/GPS

Store information from a barcode reader or GPS connected to a 10-pin terminal as Exif information.

[BCR 1 SHOT]

Read barcode information for each shot and store it as comment information. Pictures cannot be taken without reading a new barcode.

[BCR CONTINUOUS]

Store registered barcode information as comment information in every file. To erase the registered information, read the “barcode eraser” on this page or delete the letters registered in the [IMAGE COMMENT].

[GPS]

Store information from GPS device allowing latitude, longitude, altitude and UTC (standard universal coordinated time) to be recorded with photographs.

[OFF]

No store barcord or GPS information is retrieved.

MEMO

- When the barcode information is stored, **BCD** is displayed in the control panel.
 - The following ASCII characters can be used for the barcode information:
(space), 0~9, _(under bar), A~Z (lower-case characters can be entered using barcode reader, however they cannot be reviewed or edited on the [INPUT COMMENT] screen.), ! " # \$ % & ' () * + - . / : ; < = > ? @ [] { }.
- Usable types of barcode depend on the specifications of the barcode reader.

Continued ➔

- When the [BCR 1 SHOT] or [BCR CONTINUOUS] is set, the maximum number of characters or storing mode (overwrite or add) varies depending on the [IMAGE COMMENT] setting.

■ Connecting to barcode reader

You can use the barcode reader with a D-sub 9-pin connector (commercially available). Connect the barcode reader to the camera using MC-35. See the barcode reader instruction manual for details.

Barcode reader setting

- Baud rate: 4800 bps
- Data length: 8 bit
- Parity check: –
- Stop bit: 1 bit
- EOF: CR+LF

■ Barcode eraser

Use the barcode reader to read the barcode below to erase the last barcode information.



■ Using a GPS Unit

Garmin and Magellan GPS units that conform to version 2.01 of the National Marine Electronics Association NMEA0183 data format can be connected to the camera's ten-pin remote terminal using an MC-35 GPS adapter cord (available separately), allowing information on the camera's current position to be recorded when photographs are taken. Operation has been confirmed with the following devices:

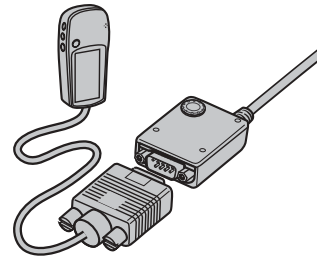

- Garmin eTrex series equipped with a PC interface cable connector
- Magellan SporTrak series equipped with a PC interface cable connector

These devices connect to the MC-35 using a cable with a D-sub 9-pin connector provided by the manufacturer of the GPS device. See the MC-35 instruction manual for details. Before turning the camera on, set the GPS device to NMEA mode (4800 baud).





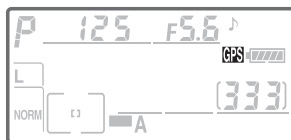

⚠ CAUTION

- When attaching the GPS device, be sure to turn the GPS device OFF.
- When attaching the GPS device, if [BARCODE READER/GPS] is set to [BCR 1 SHOT] or [BCR CONTINUOUS], the GPS device cannot be connected. Briefly turn the camera off and set to [GPS].

When the camera establishes communication with a GPS device, a  icon will be displayed in the control panel. The exposure meters will not turn off while this icon is displayed. Photo information for pictures taken while the  icon is displayed will include an additional page recording the current latitude, longitude, altitude, and Coordinated Universal Time (UTC). If no data is received from the GPS unit for two seconds, the  icon will clear from the display and the camera will stop recording GPS information. Also, the auto power save function will not be performed while the camera is communicating with a GPS device.



MEMO

- UTC data is provided by the GPS device and is independent of the camera clock.
- GPS data is only recorded when the  icon is displayed. Confirm that the  icon is displayed in the control panel before shooting. A flashing  icon indicates that the GPS device is searching for a signal; pictures taken while the  icon is flashing will not include GPS data.

SHOOTING SPEED

Choose the rate (2 frames/s or 1 frame/s) at which pictures can be taken in continuous low-speed mode.

MEMO

The frame advance rate may drop at slow shutter speeds and at  D-RANGE] setting other than [100% (STD)].

EXPOSURE DELAY MODE

Select [ON] to delay shutter release until about 0.4 s after the shutter button is pressed, reducing camera shake in situations in which the least camera movement could result in blurred photographs (for example, microscope photography).

SELF-TIMER

See p.101 for details.

QUICK PREVIEW DATA

Normally, select [ON] to playback images quickly in the LCD monitor (or [OFF] to playback images slowly). With any software application, If you encounter some difficulties with playback or printing of images with [ON] selected, select [OFF].

  **DISPLAY**

IMAGE DISPLAY

Use this setting to specify how to display images on the LCD after shooting in order to check the result.

[CONTINUOUS]

The results are always displayed after you shoot. Then images are automatically recorded.

Press the shutter button or MENU/OK to take another picture.

[4 SEC], [2 SEC]

The image appears for about 4 or 2 seconds and is then recorded.

[OFF]

The photographed image is automatically recorded without being displayed.

ILLUMINATION

This option controls the control panel backlight (LCD illuminator).

[OFF]

Control panel illuminates only while power switch is rotated to  position.

[ON]

Backlight stays lit (note that this increases battery drain).

GRID DISPLAY

Displays grid lines in the viewfinder to aid composition. (→p.22).

[ON]

Displays grid lines in the viewfinder.

[OFF]

Grid lines are not displayed in the viewfinder.

VIEWFINDER WARNING



Select [ON] (the default option) to display a warning in the viewfinder. No warning is displayed when [OFF] is selected; before shooting, check indicators in the control panel.

[ON]

Displays a warning in the viewfinder.

[OFF]

Warnings are not displayed in the viewfinder.

	Displayed when battery is low.
	Displayed when no memory card is inserted.

ROTATE IMAGE

AUTO ROTATE PLAYBACK

Choose whether photographs taken in “tall” (portrait) orientation are automatically rotated for display in the monitor.

[ON]

“Tall” (portrait) orientation photos taken with [ON] selected for [AUTO IMAGE ROTATION] are displayed in tall orientation during playback (tall orientation images are displayed at 2/3 size of other images to fit monitor).

[OFF]

“Tall” photos are displayed in “wide” (landscape) orientation.

AUTO IMAGE ROTATION

Photographs taken while [ON] (the default option) is selected contain information on camera orientation, allowing them to be rotated automatically during playback (→p.50) or when viewed in attached software. The following orientations are recorded:



Landscape
(wide)
orientation

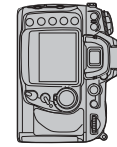

Camera rotated
90° clockwise



Camera rotated
90° counter-
clockwise



MEMO

- Camera orientation is not recorded when [OFF] is selected. Choose this option when taking photographs with the lens pointing up or down.
- In continuous mode (→p.66), orientation recorded for first shot applies to all images in same burst, even if camera orientation is changed during shooting.

AF

AF-C MODE PRIORITY

This option controls whether photographs can be taken whenever the shutter button is pressed (release priority) or only when the camera is in focus (focus priority) in continuous-servo AF.

[FPS RATE]

Photos can be taken whenever shutter button is pressed.

[FPS RATE+AF]

Photos can be taken even when camera is not in focus. In continuous mode, frame rate slows for improved focus if subject is dark or low contrast.

[FOCUS]

Photos can only be taken when in-focus indicator (●) is displayed. Note that focus does not lock when in-focus indicator is displayed.

AF-S MODE PRIORITY

This option controls whether photographs can be taken only when the camera is in focus (focus priority) or whenever the shutter button is pressed (release priority) in single-servo AF. Regardless of the setting chosen, focus will lock when the in-focus indicator (●) is displayed.

[F:FOCUS]

Photos can only be taken when in-focus indicator (●) is displayed.

[R:RELEASE]

Photos can be taken whenever shutter button is pressed.

FOCUS AREA FRAME

See p.57 for details.

GROUP DYNAMIC AF

This option controls how focus areas are grouped in group dynamic-AF (→p.56) and whether the camera gives priority to the subject in the center focus area of the selected group.

[P1: CENTER AREA]

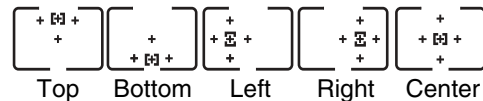

[P1: CLOSEST SUBJECT]

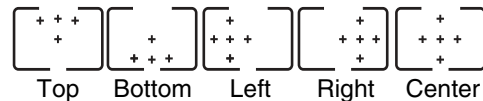

[P2: CENTER AREA]

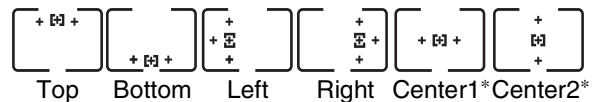

[P2: CLOSEST SUBJECT]

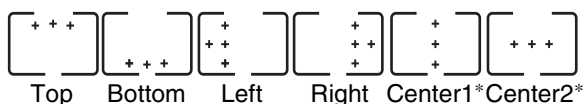

* The center focus-area group is selected by pressing the center of the multi-selector once to activate the current center focus-area group and then pressing the center of the multi-selector to toggle between Center 1 and Center 2. Center 2 is only available when [CENTER AF AREA] is selected for [CENTER BUTTON] under [MENU BUTTON ASSIGNMENT] in the [SET UP] menu.

■ Center Area

Camera focuses on subject in center focus area of selected group. Because camera does not have to select focus area, less time is required for focus operation. If subject moves out of center focus area, camera will focus based on information from other focus areas in same group. Center focus area of selected group is highlighted in control panel.

■ Closest Subject

Camera automatically selects focus area containing subject closest to camera in current focus area group. If subject moves out of selected focus area, camera will focus based on information from other focus areas in same group.

AF LOCK-ON

This option controls how autofocus adjusts to sudden large changes in the distance to the subject.

[LONG], [NORMAL], [SHORT]

Camera waits before adjusting focus when distance to subject changes abruptly. Prevents camera from refocusing when subject is briefly obscured by objects passing through frame. Select [LONG] to increase length of time before camera refocuses, [SHORT] to reduce.

[OFF]

Camera immediately adjusts focus when distance to subject changes abruptly. Use when photographing series of subjects at varying distances in quick succession.

AF ACTIVATION

This option controls whether both the shutter button and the AF-ON button can be used to initiate autofocus or whether autofocus is only initiated when the AF-ON button is pressed.

[R/A:RELEASE/AF-ON]

Autofocus can be performed with the AF-ON button or by pressing shutter button halfway.

[A:AF-ON ONLY]

Autofocus can only be performed with the AF-ON button.

AF AREA ILLUMINATION

This option controls whether or not the active focus area is highlighted in red in the viewfinder.

[AUTO]

Selected focus area is automatically highlighted as needed to provide contrast with background.

[ON]

Selected focus area is always highlighted, regardless of brightness of background. Depending on brightness of background, selected focus area may be difficult to see.

[OFF]

Selected focus area is not highlighted.

FOCUS AREA SELECTION

At the default setting of [NO WRAP], the focus-area display is bounded by the outer focus areas so that, for example, pressing the multi-selector up when the top focus area is selected has no effect. Select [WRAP] to allow focus-area selection to “wrap around” from top to bottom, bottom to top, right to left, and left to right.

BILT-IN AF-ASSIST

At the default setting of [ON], the built-in AF-assist illuminator lights to assist the focus operation when the subject is poorly lit (→p.64). Select [OFF] to turn the illuminator off.

 **EXPOSURE****AE LOCK**

This option determines what controls lock exposure.

[R/A:RELEASE/AE-L]

Exposure can be locked by pressing the AE-L/AF-L button or by pressing the shutter button halfway.

[A:AE-L ONLY]

Exposure can only be locked by pressing the AE-L/AF-L button.

ISO AUTO CONTROL

If [ON] is selected for this option, the camera will automatically adjust ISO sensitivity when necessary to help ensure optimal exposure.

[ISO AUTO CONTROL]

To change the setting, select an item and press **▶**. Then press **▲** or **▼**.

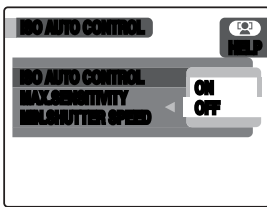

[OFF]
ISO sensitivity remains fixed at the selected value.

[ON]
If optimal exposure cannot be achieved at the selected ISO sensitivity, [ISO AUTO CONTROL] activates.

[MAX.SENSITIVITY]

To change the setting, select the item and press **▶**. Then press **▲** or **▼**.

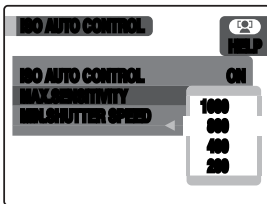

200/400/800/1600:
The maximum ISO sensitivity value can be selected when [ISO AUTO CONTROL] is activated.

[MIN.SHUTTER SPEED]

To change the setting, select the item and press **▶**. Then press **▲** or **▼**.

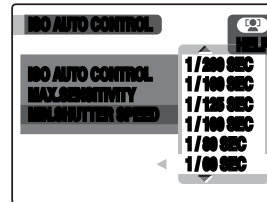

1/250–1 SEC:
The slowest shutter speed can be selected when [ISO AUTO CONTROL] is activated.

! CAUTION

The maximum ISO sensitivity will be limited to the values set in [MAX.SENSITIVITY] when [ON] is selected for the [ISO AUTO CONTROL].

MEMO

- In exposure modes **P** and **A**, ISO sensitivity will be adjusted if photo would be overexposed at shutter speed of 1/8,000 or underexposed at value selected for [MIN.SHUTTER SPEED]. Otherwise camera adjusts ISO sensitivity when limits of exposure metering system are exceeded (mode **S**) or when optimum exposure cannot be achieved at shutter speed and aperture selected by user (mode **M**). ISO sensitivity cannot be set to values over 1600 while this option is in effect.
- When a flash is used, ISO sensitivity will be adjusted for the flash level.

Continued ➔

■ ISO auto control indicator

When [ON] is selected, the control panel and viewfinder show **ISO-AUTO**. When sensitivity is altered from the value selected by the user, these indicators blink and the altered value is shown in the viewfinder (the indicators do not blink and the altered value is not shown if flash is used).

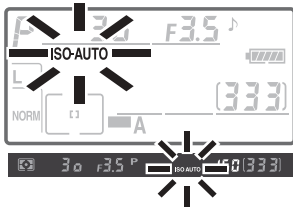

- When a flash is used, foreground subjects may be underexposed in photos taken at slow shutter speeds, in daylight, or against a bright background. Choose a flash mode other than slow sync or select mode **A** or **M** and choose a larger aperture.
- Note that because sensitivity is only altered from the value selected by the user when the limits for aperture and shutter speed are exceeded, flexible program (mode **P**) has no effect on aperture or shutter speed when the **ISO-AUTO** indicators are blinking.
- Images may become grainy at higher ISO settings.
- If the camera automatically adjusted the ISO sensitivity for the image, ISO sensitivity in the photo information is displayed in red during playback.

EV CONTROL STEPS

Choose whether adjustments to shutter speed, aperture, and bracketing are made in increments equivalent to 1/3 EV ([1/3 EV STEP], the default option), 1/2 EV ([1/2 EV STEP]), or 1 EV ([1 EV STEP]).

EXP COMP/FINE TUNE

Choose whether adjustments to exposure compensation and exposure fine tuning are made in increments equivalent to 1/3 EV ([1/3 EV STEP], the default option), 1/2 EV ([1/2 EV STEP]), or 1 EV ([1 EV STEP]).

EASY EXPOSURE COMP.

This option controls whether the  button is needed to set exposure compensation (→p.76). Exposure compensation can be set between -5 to +5. If [ON] is selected, the 0 at the center of the exposure display will blink even when exposure compensation is set to ±0.

[TEMPORARY]

Same as when [ON], except that the exposure compensation set using the command dial is only cancelled when the camera is turned off or the auto power save function activates.

[ON]

Exposure compensation set by rotating main-command dial only. The dial used depends on the option selected for [CHANGE MAIN/SUB] under [COMMAND DIALS] under  BUTTON ASSIGNMENT] in the [SET UP] menu.

		CHANGE MAIN/SUB	
		OFF	ON
Exposure mode	P	Sub-command dial	Sub-command dial
	S	Sub-command dial	Main-command dial
	A	Main-command dial	Sub-command dial
	M	N / A	

[OFF]

Exposure compensation set by pressing  button and rotating main command dial.

CENTER-WEIGHT AREA



When calculating exposure, center-weighted metering assigns the greatest weight to a circle in the center of the frame. The diameter (ϕ) of this circle can be selected from 6, 8, 10, and 13 mm (the default option is 8 mm; note that the diameter is fixed at 8 mm when a non-CPU lens is used, regardless of the setting selected for the [NON-CPU LENS DATA] under  MISC] in the [SET UP] menu(→p.121)).

FINE TUNE EXPOSURE

Use this option to fine-tune the exposure value selected by the camera. Exposure can be fine tuned separately for each metering method by from +1 to -1 EV in steps of 1/6 EV.

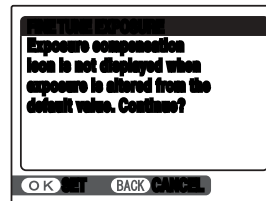
1 Display the confirmation screen.



① Press  or  to select [FINE TUNE EXPOSURE].



② Press .

Continued ➔ 157



③ Press MENU/OK.

2 Change the setting.

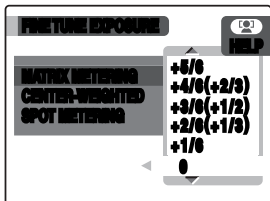

① Press ▲ or ▼ to select the metering to change.



② Press ►.



③ Press ▲ or ▼ to change the setting.



④ Press MENU/OK to confirm the setting.



FLASH/BKT

FLASH SYNC SPEED

This option controls flash sync speed. Options range from 1/250 s ([1/250], the default setting) and 1/60 s ([1/60]).

[1/250], [1/200], [1/160], [1/125], [1/100], [1/80], [1/60]

Select one of the above speeds for the flash sync.

[1/250(AUTO FP)]

To enable auto FP high-speed sync when using Speedlights that support the Nikon Creative Lighting System (CLS), select [1/250(AUTO FP)] (flash sync speed will be set to 1/250 s if the built-in flash fires or the attached Speedlight is not CLS-compatible). When the camera shows a shutter speed of 1/250 s in exposure mode **P** or **A**, auto FP high-speed sync will be activated if the actual shutter speed is faster than 1/250 s.

■ Fixing shutter speed at the flash sync speed limit

To fix shutter speed at the sync speed limit in shutter-priority auto or manual exposure modes, select the shutter speed after the slowest possible shutter speed (30 s or **b** **w** **L** **b**). An **X** will be displayed in the flash sync indicator in the control panel and viewfinder.

FLASH Tv SPEED

This option determines the slowest shutter speed possible when using front- or rear-curtain sync or red-eye reduction in programmed auto or aperture-priority auto exposure mode (regardless of the setting chosen, shutter speeds can be as slow as 30 s in shutter-priority auto and manual exposure modes or when the flash is set to slow sync, slow rear-curtain sync, or red-eye reduction with slow sync). Options range from 1/60 s to 30 s.

BUILT-IN FLASH

Choose the flash mode for the built-in flash.

[TTL⚡: TTL MODE]

Flash output is adjusted automatically in response to shooting conditions.

[M⚡: MANUAL MODE]

Built-in flash fires at the selected output. No monitor preflash is emitted, allowing the built-in flash to function as a master flash for Nikon slave flash units when used with a Nikon remote Speedlight commander such as the SU-4.

[R⚡: REPEATING MODE]

The flash fires repeatedly while the shutter is open, producing a strobe-light effect.

[C⚡: COMMANDER MODE]

Choose this option to use the built-in flash as a master flash controlling one or more Nikon remote Speedlights in up to two groups (A and B) using Advanced Wireless Lighting.

Continued ➔

■ Setting the manual flash mode

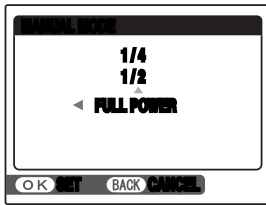

① Press ▲ or ▼ to select [M↕:MANUAL MODE].



② Press ►.



③ Press ▲ or ▼ to select the output.



④ Press MENU/OK to confirm the setting.

 **MEMO**

If [FULL POWER] is selected, the guide number for the built-in flash is 13/42 (m/ft, ISO 100).

■ Setting the repeating

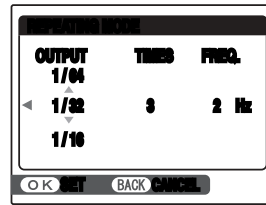

① Press ▲ or ▼ to select [R↕:REPEATING MODE].



② Press ►.



③ Press ▲ or ▼ to select the output.



④ Press ► to change next setting.

⑤ Repeat the steps for ③–④ to change the [TIMES] and [FREQ.] settings.



⑥ Press MENU/OK to confirm the setting.

[OUTPUT]

Highlight flash output (expressed as fraction of full power).

[TIMES]

Choose number of times flash fires at selected output.
 Note that depending on shutter speed and option selected for Interval, actual number of flashes may be less than selected.

[FREQ.]

Choose number of times flash fires per second.

■ Times

The number of times the flash can fire in succession is determined by flash output.

Options available for [Times]	Output					
	1/4	1/8	1/16	1/32	1/64	1/128
2	✓	✓	✓	✓	✓	✓
3		✓	✓	✓	✓	✓
4		✓	✓	✓	✓	✓
5		✓	✓	✓	✓	✓
6			✓	✓	✓	✓
7			✓	✓	✓	✓
8			✓	✓	✓	✓
9			✓	✓	✓	✓
10			✓	✓	✓	✓
15				✓	✓	✓
20					✓	✓
25					✓	✓
30						✓
35						✓



Continued →

Setting the commander mode

Choose this option to use the built-in flash as a master flash controlling one or more remote optional Speedlights in up to two groups (A and B) using Advanced Wireless Lighting.

[BUILT-IN]

Choose flash mode for built-in flash (commander flash).

TTL	i-TTL mode. Menu of flash compensation values will be displayed; choose value between +3.0 and -3.0 EV in steps of 1/3 EV. At settings other than ±0,  will be displayed in control panel and viewfinder.
M	Choose flash output level for built-in flash from values between full power and 1/128 power (1/128 of full power).  flashes in control panel and viewfinder.
—	Built-in flash does not fire, but AF-assist illuminator lights. Built-in flash must be raised to allow monitor preflashes to fire.  is not displayed in control panel flash-sync mode display.

[A GRP.]

Choose flash mode for all flashes in group A.

TTL	i-TTL mode. Menu of flash compensation values will be displayed; choose value between +3.0 and -3.0 EV in steps of 1/3 EV.
AA	Auto aperture (not available with SB-600 and SB-R200 Speedlights). Menu of flash compensation values will be displayed; choose value between +3.0 and -3.0 EV in steps of 1/3 EV.
M	Choose flash output level for flashes in Group A from values between full power and 1/128 power (1/128 of full power).
—	Flashes in group A do not fire.

[B GRP.]

Choose flash mode for all flashes in group B.

TTL	i-TTL mode. Menu of flash compensation values will be displayed; choose value between +3.0 and -3.0 EV in steps of 1/3 EV.
AA	Auto aperture (not available with optional SB-600 and SB-R200 Speedlights). Menu of flash compensation values will be displayed; choose value between +3.0 and -3.0 EV in steps of 1/3 EV.
M	Choose flash output level for flashes in group B from values between full power and 1/128 power (1/128 of full power).
—	Flashes in group B do not fire.

[CH]

Choose from channels 1–4. All Speedlights in both groups must be set to same channel.

1 Set the menu.

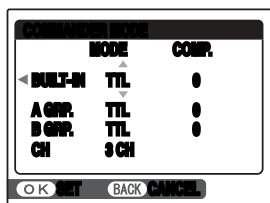

① Press ▲ or ▼ to select [C⚡:COMMANDER MODE].



② Press ►.



③ Press ▲ or ▼ to change the setting.



④ Press ► to go to the next setting.

⑤ Repeat the steps for ③–④ to change settings for items.



⑥ Press MENU/OK to confirm the settings.

2 Shooting.

① Compose shot and arrange Nikon Speedlights as shown below.

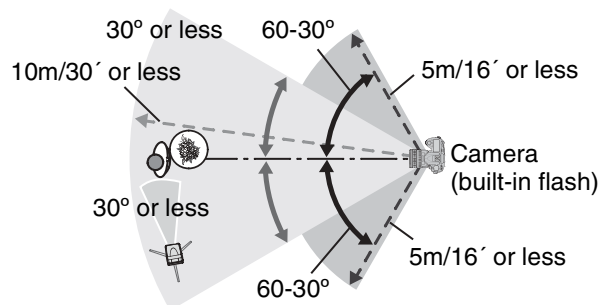

Speedlight wireless remote sensor should face camera.

- Maximum distance between optional Speedlights and camera is about 10m (33') when Speedlight is positioned in front of camera (within 30° on either side of center line), or about 5 m (16') when Speedlight is 30–60 ° to either side of center line.

② Turn all Nikon Speedlights on and set the group and channel for all Speedlights. See Speedlight manual for details.

Continued ➔

- ③ Press flash pop-up button to raise built-in flash (note that built-in flash must be raised even if [-] is selected for the [MODE] under [BUILT-IN]).

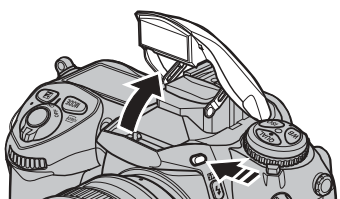

- ④ After confirming that camera flash-ready light and flash-ready lights for all Speedlights are lit, frame photograph, focus, and shoot.
- If [ON] is selected for [MODELING FLASH] under [FLASH/BKT] in the [SET UP] menu (→p.165), all flashes will emit a modeling flash when the depth-of-field preview button is pressed.
 - Commander mode can also be used with FV lock (→p.85).

MEMO Commander Mode

- Position the sensor windows on the Nikon Speedlights where they will pick up the monitor preflashes from the built-in flash (take particular care when not using a tripod).
- Be sure that direct light or strong reflections from the Nikon Speedlights do not enter the camera lens (in TTL mode) or the photocell on the optional Speedlight (AA mode), as this may interfere with exposure. To prevent the timing flashes emitted by the built-in flash from appearing in photographs taken at short ranges, use a low ISO sensitivity and small aperture (large f/-number) or an Nikon SG-3IR infrared panel for the built-in flash. An SG-3IR is required for best results with rear-curtain sync, which produces brighter timing flashes. After positioning the Speedlights, take a test shot and view the results in the camera monitor.
- Although there is no limit on the number of Nikon Speedlights that may be used, the practical maximum is three. With more than this number, the light emitted by the other flash units will interfere with performance. All Speedlights must be in the same group; flash compensation (→p.84) applies to all Speedlights. See the Speedlight manual for more information.

MODELING FLASH

At the default setting [ON], the built-in flash and Nikon Speedlights that support the Nikon Creative Lighting System will emit a modeling flash when the depth-of-field preview button is pressed. Select [OFF] to disable this feature.

AUTO BRACKETING SET

This option controls what settings are affected when auto bracketing is in effect.

[AE & FLASH]

Camera performs exposure and flash bracketing.

[AE ONLY]

Camera performs exposure bracketing only.

[⚡:FLASH ONLY]

Camera performs flash bracketing only.

AUTO BKT IN M EXP.MODE

This option controls what settings are affected when [AE & FLASH] or [AE ONLY] is selected for [AUTO BRACKETING SET] in manual exposure mode.

Option	Description
⚡Tv	Camera varies shutter speed ([AUTO BRACKETING SET] set to [AE ONLY]) or shutter speed and flash level ([AUTO BRACKETING SET] set to [AE & FLASH]).
⚡Tv/Av	Camera varies shutter speed and aperture ([AUTO BRACKETING SET] set to [AE ONLY]) or shutter speed, aperture, and flash level ([AUTO BRACKETING SET] set to [AE & FLASH]).
⚡Av	Camera varies aperture ([AUTO BRACKETING SET] set to [AE ONLY]) or aperture and flash level ([AUTO BRACKETING SET] set to [AE & FLASH]).
⚡FLASH	Camera varies flash level only ([AUTO BRACKETING SET] set to [AE & FLASH]).

* If no flash is attached when [ON] is selected for [ISO AUTO CONTROL] under [ISO AUTO CONTROL] under [EXPOSURE] in the [SET UP] menu, camera will vary ISO sensitivity only, regardless of the setting selected.

* Flash bracketing performed only with i-TTL or AA flash control.

AUTO BKT ORDER

This option controls the order in which bracketing is performed.

[N:MTR>UNDER>OVER]

Bracketing performed in order described in bracketing program (→p.106).

[:UNDER>MTR>OVER]

Bracketing proceeds in order from lowest to highest value.

AUTO BKT SELECTION

This option controls how the bracketing program is selected.

[MANUAL VALUE SELECT]

Pressing BKT button, rotate main-command dial to select number of shots, sub-command dial to select bracketing increment.

[PRESET VALUE SELECT]

Pressing BKT button and rotate main-command dial to turn bracketing on and off. Pressing BKT button and rotate sub-command dial to select number of shots and bracketing increment.

BUTTON ASSIGNMENT

AE-L/AF-L BUTTON

This option controls the behavior of the AE-L/AF-L button.

[AE/AF Lock]

Both focus and exposure lock while the AE-L/AF-L button is pressed.

[AE LOCK ONLY]

Exposure locks while the AE-L/AF-L button is pressed. Focus is unaffected.

[AE LOCK HOLD/RESET]

Exposure locks when the AE-L/AF-L button is pressed and remains locked until the button is pressed again, shutter is released or exposure meters turn off .

[AE LOCK HOLD]

Exposure locks when the AE-L/AF-L button is pressed and remains locked until the button is pressed again or the exposure meters turn off .

[AF LOCK ONLY]

Focus locks while the AE-L/AF-L button is pressed. Exposure is unaffected.

CENTER BUTTON

This option determines what operations can be performed by pressing the center of the multi-selector.

[CENTER AF AREA]

Pressing the center of the multi-selector selects the center focus area or center focus area group (group dynamic-AF). If [P2: CENTER AREA] or [P2:CLOSEST SUBJECT] is selected for the [GROUP DYNAMIC AF] under [AF], the center of the multi-selector can be used to toggle between center focus area groups.

[ILLUMINATE AF AREA]

Pressing the center of the multi-selector illuminates the active focus area or focus area group (group dynamic-AF) in viewfinder.*

[NOT USED]

Pressing the center of the multi-selector has no effect when the camera is in shooting mode.*

* The center of multi-selector cannot be used to toggle between the center focus-area groups, even if [P2: CENTER AREA] or [P2:CLOSEST SUBJECT] is selected for the [GROUP DYNAMIC AF] under [AF] (→p.152).

MEMO

This function cannot be performed when the focus area is locked by the focus-selector lock.

MULTI-SELECTOR

Press the multi-selector to ready the camera (wakeup) from standby status after the auto power save function was activated, or to initiate autofocus.

[DO NOTHING]

The camera will not return to ready from the standby status when the multi-selector is pressed.

[WAKE-UP]

The camera will go to ready by pressing the multi-selector.

[INITIATE AUTOFOCUS]

The camera will go to ready by pressing the multi-selector and will perform autofocus while the multi-selector is pressed (except when manual is selected for focus mode).

FUNC. BUTTON

This option controls the function performed by the FUNC. button.

[FV LOCK]

If built-in flash or Nikon CLS-compatible Speedlight is used, flash value locks when FUNC. button is pressed. Press again to cancel FV lock.

[FV LOCK/LENS DATA]

Same as above, except that if built-in flash is lowered or Nikon CLS-compatible Speedlight is not attached, use the FUNC. button and command dials to specify focal length and aperture of non-CPU lenses (→p.122, 123).

[1 STEP Tv/Av]

If FUNC. button is pressed when rotating command dials, changes to shutter speed (exposure modes S and M) and aperture (exposure modes A and M) are made in increments of 1 EV.

[SAME AS AE-L/AF-L]

FUNC. button performs same functions as AE-L/AF-L button.

[FLASH OFF]

Flash will not fire in photos taken while FUNC. button is pressed.

[BRACKETING BURST]

While FUNC. button is pressed, all shots in exposure or flash bracketing program will be taken each time the shutter button is pressed. In continuous high-speed and continuous low-speed modes, camera will repeat bracketing burst while the shutter button is held down.

[MATRIX METERING]

Matrix metering activated while FUNC. button is pressed.

[CENTER-WEIGHTED]

Center-weighted metering activated while FUNC. button is pressed.

[SPOT METERING]

Spot metering activated while FUNC. button is pressed.

[FOCUS AREA FRAME]

Press FUNC. button and rotate sub-command dial to cycle between normal and wide focus areas (→p.57).

FUNCTION LOCK

To avoid mis-use, lock the functions of the command dial, [SHOOTING MENU] and [SET UP] menu.

[LOCK SETTING]

Select [ALL FUNCTION], [SELECTED FUNCTION], or [BASIC FUNCTION] for the [LOCK SETTING].

UNLOCK	Releases the lock for functions.
ALL FUNCTION	Locks the functions which can be locked in [BASIC FUNCTION] and the functions which can be specified in [SELECTED FUNCTION].
SELECTED FUNCTION	Locks the specified functions. To specify the functions, use [FUNCTION SELECTION]. The functions locked by the [BASIC FUNCTION] will also be locked when the [SELECTED FUNCTION] is set.
BASIC FUNCTION	Locks all functions except the functions which can be specified by the [SELECTED FUNCTION].

[FUNCTION SELECTION]

Specifies functions to be locked when [SELECTED FUNCTION] is selected for [LOCK SETTING].

[CHANGE PASSWORD]

Change password when [LOCK SETTING] activates.

These functions can be specified by the [SELECTED FUNCTION]

- FORMAT
- ERASE
- APERTURE
- SHUTTER SPEED
- EXP. COMPENSATION
- TONE/COLOR/SHARP
- D-RANGE
- COLOR SPACES
- FILM SIMULATION
- QUALITY
- WHITE BALANCE
- ISO
- NOISE REDUCTION
- EXPOSURE MODE
- FLASH COMPENSATION
- MAINTENANCE
- DATE/TIME-TIME DIF
- FILE TAG OPTIONS

The functions to be locked by the [BASIC FUNCTION]

- All options in the [SET UP] menu (except [FUNCTION LOCK], [FORMAT]).
- Auto bracketing
- Two-button reset

MEMO

- The following functions can be used even when [FUNCTION LOCK] is set.
 - Playback (▶, [M])
 - Release (AF-ON button, AE-L/AF-L button)
- Specify the functions using [FUNCTION SELECTION] before setting the [SELECTED FUNCTION] under [LOCK SETTING] (→p.170).

Continued ➔

■ Making the Lock Setting

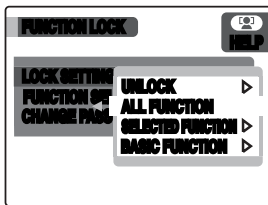

① Press ▲ or ▼ to select [LOCK SETTING].



② Press ►.



③ Press ▲ or ▼ to select options for [LOCK SETTING].



④ Press ► to display the confirmation screen.
If the [INPUT PASSWORD] screen is displayed, enter the password, then press MENU/OK.



⑤ Press MENU/OK to confirm the setting.

MEMO

If the menu is locked, it cannot be selected while the function lock is active.

■ Setting the function to be locked

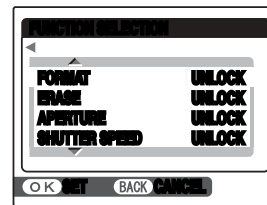

① Press ▲ or ▼ to select [FUNCTION SELECTION].



② Press ►.



③ Press ▲ or ▼ to select the function to be locked.



④ Press ►.

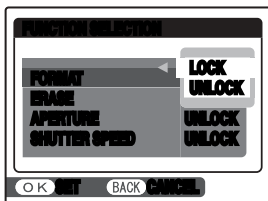

⑤ Press ▲ or ▼ to change the setting.



⑥ Press ◀ to return to selecting a function.

⑦ Repeat step ③–⑥ to change the settings of functions.



⑧ Press MENU/OK to confirm the setting.

■ Setting the password

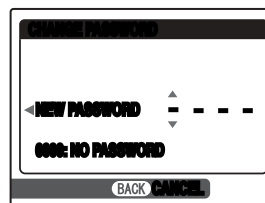

① Press ▲ or ▼ to select [CHANGE PASSWORD]



② Press ▶.



③ Press ▲▼◀▶ to enter a new password.



④ Press MENU/OK to confirm the setting.



⑤ Press MENU/OK after the confirmation screen is displayed. Press ◀ to return to the [FUNCTION LOCK] setting screen, if necessary.

Continued ➔

 MEMO

To change the password

If a password has been previously set, the following screen is displayed in step ③.

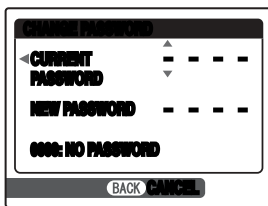

Enter the preset password and new password to change the password. **If you set [NEW PASSWORD] to [0000], the password setting is canceled.**

COMMAND DIALS

This option controls the operation of the main and sub-command dials.

[ROTATE DIRECTION]

Controls direction of rotation for the command dial operation when setting flexible program, shutter speed, aperture, easy exposure compensation, exposure mode, exposure compensation value, bracketing increment, and flash sync mode.

Select [ROTATE DIRECTION] and press ► on the multi-selector. Press ▲▼ to change the setting.

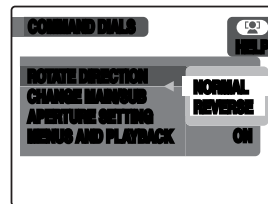

[NORMAL]

Normal command dial operation.

[REVERSE]

Reverses rotation of command dials.

[CHANGE MAIN/SUB]

Exchanges functions of main and sub-command dials when setting shutter speed and aperture.

Select [CHANGE MAIN/SUB] and press ► on the multi-selector. Press ▲▼ to change the setting.

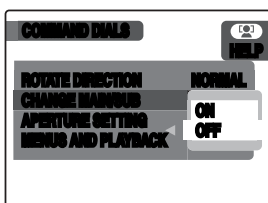
**[ON]**

Main-command dial controls aperture, sub-command dial controls shutter speed.

[OFF]

Main-command dial controls shutter speed, sub-command dial controls aperture.

[APERTURE SETTING]

Controls whether changes to aperture are made using lens aperture ring or command dials.

Select [APERTURE SETTING] and press ► on the multi selector. Press ▲▼ to change the setting.

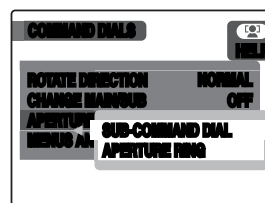
**[SUB-COMMAND DIAL]**

Aperture can only be adjusted with sub-command dial (or main command dial if [CHANGE MAIN/SUB] is [ON]).

[APERTURE RING]

Aperture can only be adjusted using lens aperture ring. Camera aperture display shows aperture in increments of 1 EV. This option is selected automatically when non-CPU lens is attached.

 **MEMO**

Regardless of setting chosen, the lens ring must be used to set aperture for non-CPU lenses, while the command dials to set aperture for type G lenses not equipped with aperture ring.

Continued ➔

[MENUS AND PLAYBACK]

Controls functions performed by command dials during playback or when menus are displayed.

Select [MENUS AND PLAYBACK] and press ► on the multi-selector. Press ▲▼ to change the setting.

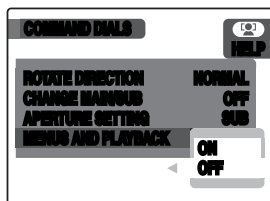
**[ON]**



Main-command dial performs same function as pressing multi-selector left or right. Sub-command dial performs same function as pressing multi-selector up or down. Note that this option has no effect on the roles played by the command dials during playback zoom.

[OFF]

Multi-selector used to choose picture displayed, highlight thumbnails, and navigate menus.

- Single-frame playback: the main-command dial is used to display additional photo information, or to zoom in on an image. The sub-command dial is used to choose a picture to display.
- Multi-frame playback: the main-command dial moves the cursor up or down, the sub-command dial moves the cursor left or right.
- Menu navigation: main-command dial moves highlight bar up or down. Rotate sub-command dial to right to display sub-menu, to left to return to previous menu.

BUTTON AND DIAL

This option allows adjustments that are normally made by pressing the MODE, , BKT, , ISO, QUAL, or WB button and rotating a command dial to be made by rotating the command dial after the button is released.

[DEFAULT]

Changes to settings made by rotating command dial while button is held down.

[HOLD]

Settings can be changed by rotating command dial after button is released. To exit, press button again, press the shutter button halfway, or wait for about 20 s. Waiting for about 20 s will not allow exit when [AUTO POWER SAVE] is set to [OFF].

TEST-SHOOTING (NO CARD)

This option can be used to disable the shutter release when no memory card is inserted in the camera. The default setting allows the shutter to be released without a memory card inserted in the camera.

[OFF]

Shutter button disabled when no memory card is inserted.

[ON]

Shutter button enabled when no memory card is inserted.

Photographs taken when no memory card is inserted are not saved, although they will be displayed in the LCD monitor.

MISC.

NON-CPU LENS DATA

See p.121 for details.

MB-D200 BATTERY TYPE

To ensure that the camera functions as expected when AA batteries are used in the Nikon MB-D200 battery pack, match the option selected in this menu to the type of battery inserted in the battery pack. There is no need to adjust this option when using NP-150 batteries.

CAUTION

When using AA batteries with the Nikon MS-D200 AA Battery Holder (supplied accessory of MB-D200), the remaining battery level cannot be checked. In this case, there is a possibility of shooting failure. Therefore, the camera functions are not guaranteed when using AA batteries. Also, the following batteries cannot be used:

- AA manganese battery
- AA NiCad battery
- AA lithium battery

The rechargeable battery, NP-150, is recommended.

AF-ON FOR MB-D200

This option controls the function assigned to the AF-ON button for the optional MB-D200 battery pack.



FILE TAG OPTIONS

Sets the data (such as tag information) which is effective when the saved image is used with an application.

[MASKING]

Part of an image can be masked when using the optional Hyper-Utility HS-V3 Software. Select the optimal aspect ratio for the desired printing range. A partial image from the range will be masked when the image is displayed. This function is best for a presentation of images, for example.

Select the item and press  on the multi-selector.

Then press   to change the setting.

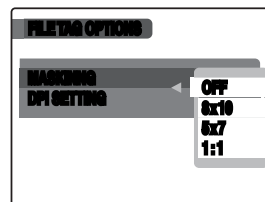

[OFF] Do not mask.

[8×10] Mask using 8x10 aspect ratio.

[5×7] Mask using 5x7 aspect ratio.

[1:1] Mask using 1x1 aspect ratio (square).

Continued 

[DPI SETTING]

Sets the number of pixels per inch to define the image data in length. The set information will be recorded on the tag information. The value can be set between 36 and 3000 DPI.

Select the item and press ► on the multi-selector to display the setting screen.

Use ▲▼ to change the setting.



 **MEMO**

Recommendation:

- Use the following values based on which Image Size Setting was selected when image was taken and if the desired print size of the short side is 8 inches (20.3 cm).
 - L (4256x2848): 356 DPI
 - M (3024x2016):252 DPI
 - S (2304x1536): 192 DPI
- Use the following values based on which Image Size Setting was selected when image was taken and if the desired print size of the short side is 5 inches (12.7 cm).
 - L (4256x2848): 570 DPI
 - M (3024x2016):403 DPI
 - S (2304x1536): 307 DPI

 **MAINTENANCE**

BATTERY INFO

View information on the rechargeable battery NP-150 currently inserted in the camera.

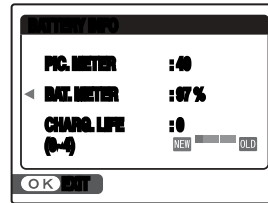

[PIC. METER]

Number of times shutter has been released with current battery since battery was last charged. Note that camera may sometimes release shutter without recording photograph, for example when measuring value for preset white balance.

[BAT. METER]

Current battery level as a percentage. Battery level may not be 100% even immediately after the battery is fully charged, depending on the ambient temperature in which the battery is being charged or used.

[CHARG. LIFE]

Five-level display showing battery age. 0 (New) indicates that battery performance has not been affected; 4 (Replace) indicates that battery has reached end of charging life and should be replaced.

FIRMWARE VERSION

View the camera firmware version.

MAINTENANCE COUNTER

View the number of times the shutter has been released ([NO OF PICTURE]), or how many times the shutter unit has been replaced ([UNIT REPLACE]). [NO OF PICTURE] is displayed in 100 unit increments.

MIRROR LOCK-UP (CLEANING)

This option is used to lock the mirror in the up position to allow inspection or cleaning of the CCD. See “Cleaning the CCD” (→p.204).

TIME・言語/LANG.

DATE/TIME

See p.36 for details.

TIME DIFFERENCE

Use this function when traveling to destinations in different time zones. This function sets a time difference relative to the date and time currently set. When this setting is enabled, the specified time difference is applied when pictures are taken.

1 Use time difference function.



Press ▲ or ▼ to change between [HOME] and [+ LOCAL].

To set the time difference, select [+ LOCAL].

[HOME] Your home time zone

[+ LOCAL] Your destination time zone

Continued ➔

2 Move to [TIME DIFFERENCE] screen.



3 Set time difference.

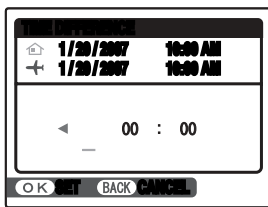

① Press ◀ or ▶ to select +/-, hour, and minute.



② Press ▲ or ▼ to change the setting.



③ Always press MENU/OK after the settings are completed.

✓ CHECK

Available time setting

-23:45 to +23:45 (in 15-minute increments)

📄 MEMO

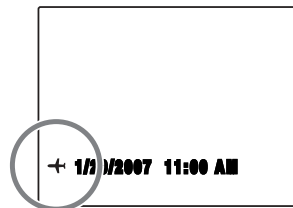

In the time difference setting, when you change to the shooting mode, ⏪ and the date is displayed for 3 seconds. Also, the date display turns yellow.

✓ CHECK

Upon returning from a trip, always change the time difference setting back to [HOME] and then check the date and time again.



See p.36 for details.

SYSTEM

FORMAT

Initialize (format) the memory card for use with the camera.

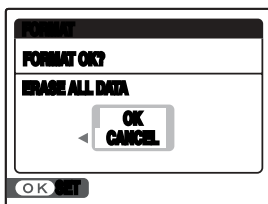

① Press ▲ or ▼ to select OK.



② Press MENU/OK to initialize the memory card.

CAUTION

- The Format function erases all the frames (files), including protected frames (files). Back up important frames (files) onto your PC or another media before formatting your memory card.
- Do not open the battery cover or slot cover during formatting, as formatting will be interrupted.

USB MODE

Before connecting the camera to a computer via USB (→p.194), select the appropriate USB option as determined by the computer operating system.

[MTP] MTP (PTP)]

Normally selected. Select [MTP (PTP)] to send pictures to the PC or to use PictBridge. The camera can be safely detached without eject operation from the PC.

[CAMERA] PC SHOOT. AUTO]

The camera automatically operates in PC shooting mode when connected to the PC with the USB cable, and shot images will be saved to the hard disc in the PC. When not connected to the PC, the camera operates normally, and shot images are saved to the memory card in the camera.

* The images not transferred to the PC will be lost if the USB cable is disconnected during shooting.

[CAMERA] PC SHOOT. FIXED]

The camera automatically operates in PC shooting mode when connected to the PC with the USB cable, and shot images will be saved to the hard disc in the PC.

Once the camera is connected to the PC, even when the USB cable is disconnected during shooting, shot images will be saved to the camera's memory buffer, and can be transferred to the hard disc in the PC later unless the camera is turned off. However in this case, shot images will not be recorded to the memory card in the camera.

FRAME NO.

Use this function to specify whether frame numbers are assigned consecutively from previous numbers or begin again.

	<CONTINUOUS>	<RENEW>
A	0001 ⋮ 0005	0001 ⋮ 0005
↓		
B	0006 ⋮ 0010	0001 ⋮ 0005

* Formatted memory card used for both A and B.

[CONTINUOUS]

Pictures are stored beginning from the highest file number stored on the last memory card used.

[RENEW]

Pictures are stored on each memory card beginning with a file number 0001. Each image will be numbered consecutively from the last number used. So when recorded images in the memory card are erased, the number of the erased frame will not be used again. Even erasing all frames in the memory card will not return the number to 0001.

CHECK

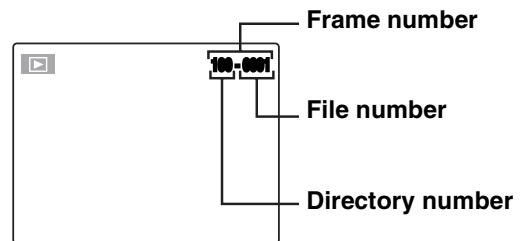

The last 4 digits of the 7-digit number in the top right corner of the screen are the file numbers, while the first 3 digits show the directory number.

MEMO

- Setting this function to [CONTINUOUS] makes file management easier as it makes sure that file names are not duplicated when images are downloaded to a PC.
- When the camera settings are [SET-UP RESET] (→p.181), the frame number setting ([CONTINUOUS] or [RENEW]) is changed to [CONTINUOUS] and the frame number itself does not return to 0001.
- In [CONTINUOUS] setting, images are stored beginning from the highest file number on the current memory card when the memory card already contains image files with file numbers higher than the highest file number on the last memory card.
- The displayed frame number may differ for images photographed on other cameras.
- When the number of files in a single folder exceeds 1000, a new folder will be created.

AUTO POWER SAVE

When this function is active and the camera remains unused for a pre-determined amount of time (15sec/30sec/1min/2min/5min/10min), the camera automatically shuts down (standby status). The viewfinder display, the aperture and shutter speed indicators in the control panel will turn off in standby status. Use this function when you want to get the maximum possible running time from your battery.

! CAUTION

The auto power save function is disabled during a slide show (→p.133), when a printer or a PC is connected (→p.183, 194), and when the AC power adapter is being used.

📄 MEMO

Press  or the shutter button halfway to return the camera back to ready status.

BEEP

Controls the pitch of the beep that sounds when the self-timer is counting down or the camera is focusing.

[LOW] Low pitch beep

[HIGH] High pitch beep

[OFF] No beep

📄 MEMO

When [LOW] or [HIGH] is selected,  beep indicator is displayed in the control panel.

VIDEO SYSTEM

Specifies whether video output is set to [NTSC] or [PAL].

SET-UP RESET

Returns all camera settings (other than [ PRESET CUSTOM], [DATE/TIME], [言語/LANG.] and [VIDEO SYSTEM]) to their factory default values.

Connecting to a TV

For easier viewing, you can connect to a TV so the images can be displayed on a larger screen.

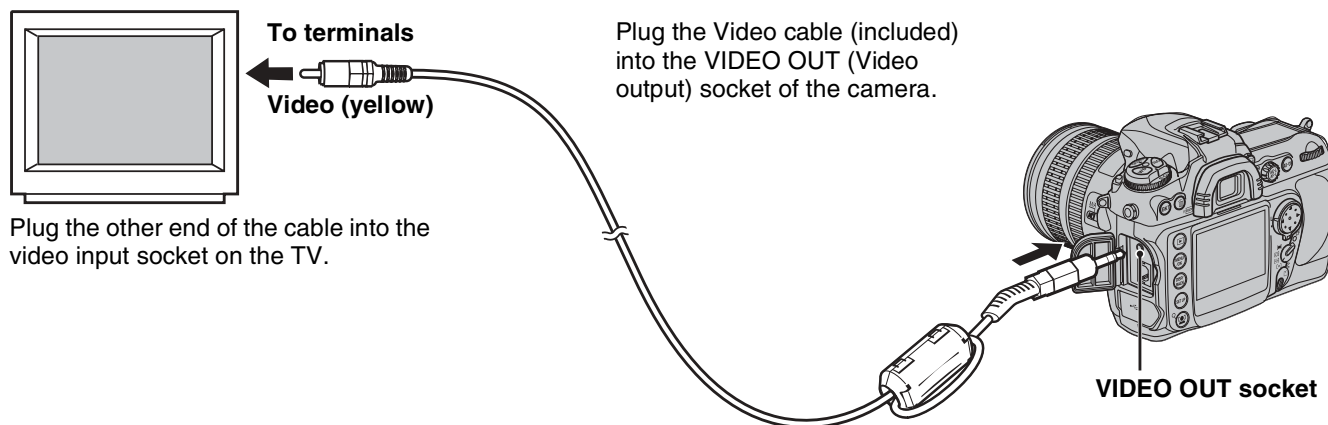

⚠ CAUTION

- Plug the Video cable (included) and the AC power adapter correctly and push them in each terminal.
- See p.210 for the information of the AC power adapter.

📄 MEMO

- When connecting the Video cable (included) to TV, the camera's screen is turned off.
- Use the AC-135VN (sold separately) when IS Pro is connected to a TV for long periods.

Connecting Camera Directly to Printer — PictBridge Function



When a printer that supports PictBridge is available, images can be printed by connecting the camera directly to the PictBridge-compatible printer without a PC.

Before connecting to a printer

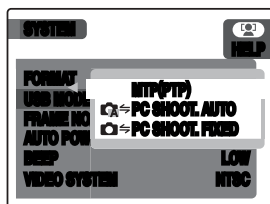

- ① Select [**MTP** MTP (PTP)] for [USB MODE] under [**SYSTEM**] in the [SET UP] menu. See “Using the [SET UP] menu” (→p.138).
- ② Turn the power switch to OFF to turn the camera off.

Connecting to a printer

- ① Connect the camera to your printer using the USB cable (mini-B).

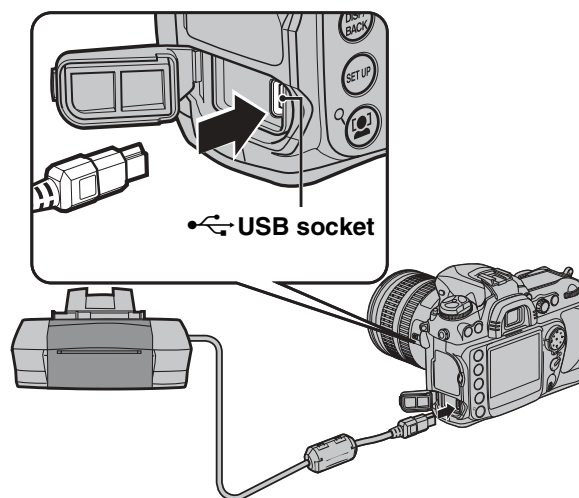

MEMO

Use the AC-135VN (sold separately) when IS Pro is connected to a printer.

Continued ➔

- ② Connect the camera to a printer and turn the printer on.
Set the Power switch to ON to turn the camera on.

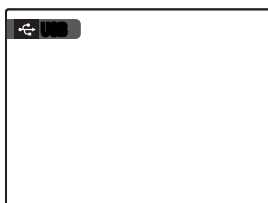

[USB] appears on the screen.

- ③ The following screen appears on the screen after a moment.

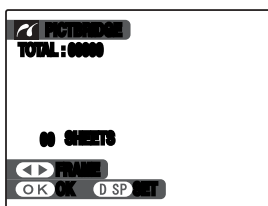

“Specifying images for printing”
→p.184
“Printing with DPOF setting”
→p.185

MEMO

Depending on the printer, some functions are disabled.

Specifying images for printing (PRINT WITH DATE / PRINT WITHOUT DATE)

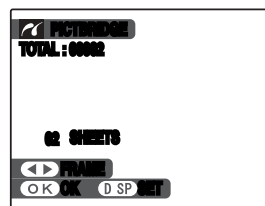

- ① Press ◀ or ▶ to display the frame (file) for specifying PRINT setting.



- ② Press ▲ or ▼ to set a value.
Up to 99 sheets are printed.

To specify more PRINT settings, repeat steps ① and ②.



- ③ Press MENU/OK to display the confirmation screen.



- ④ Press MENU/OK again to download the data to the printer and start printing the specified number of prints.

MEMO

Even if MENU/OK is pressed with the total number of images set at 0 (zero), the confirmation message appears for one print of the displayed image. Press MENU/OK again to start printing.

MEMO Printing with date

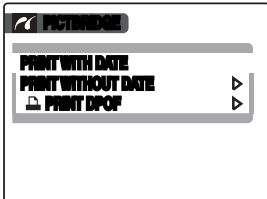

- ① Press DISP/BACK to display the setting display.
- ② Press ▲ or ▼ to select [PRINT WITH DATE].
- ③ Press MENU/OK.

CAUTION

[PRINT WITH DATE] is not available when the camera is connected to a printer that does not support date printing.

Printing with DPOF setting (PRINT DPOF)

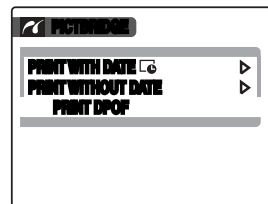

- ① Press DISP/BACK to open the menu.



- ② Press ▲ or ▼ to select [PRINT DPOF].



- ③ Press MENU/OK to display the confirmation screen.

Continued ➔

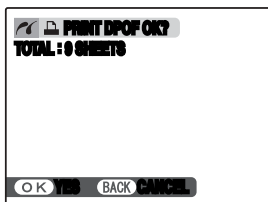

- ④ Press MENU/OK again to download the data to the printer and start printing the specified frames (files) continuously.

 **CHECK**

To select [PRINT DPOF], the DPOF settings must be specified on IS Pro beforehand (→p.128).

 **CAUTION**

Even when [WITH DATE] is specified in the DPOF settings (→p.128), the date is not inserted on printers that do not support date printing.

 **MEMO**

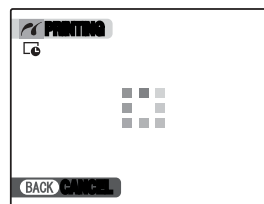

Press DISP/BACK to cancel the printing. Depending on the printer, the printing may not be canceled immediately or printing may stop midway through. When printing stops midway, briefly turn the camera off and then on again.

Disconnecting the printer

- ① Check that [PRINTING] is not displayed on the camera's screen.
 - ② Turn the camera off. Unplug the USB cable (mini-B).
-

! **CAUTION**

- In PictBridge function, images photographed anything other than a digital camera may not print properly.
- The camera cannot be used to specify printer settings such as the paper size and print quality.
- For best result, please connect the AC Power Adapter AC-135VN (sold separately) to your camera while using with a PictBridge printer.
- Use memory card that was formatted on IS Pro.
- Movies and CCD-RAW images cannot be printed.
- Images photographed with a camera other than the IS Pro may not print properly.
- When [ON] is set for the [QUICK PREVIEW DATA] under [SHOOTING] in the [SET UP] menu, images may not print properly.

Installation on a Windows PC

Pre-installation checklist

Hardware and software requirements

To run this software, you must have the hardware and software described below. Check your system before you begin the installation.

Operating System*1	Windows 98 SE Windows Millennium Edition (Windows Me) Windows 2000 Professional*2*3 Windows XP Home Edition*2 Windows XP Professional*2 Windows Vista*2
CPU	200 MHz Pentium minimum (Windows XP/Vista users: 800MHz Pentium 4 or better recommended)
RAM	64 MB minimum (128 MB minimum for Windows XP , 512 MB minimum for Windows Vista) Minimum 768 MB when converting CCD-RAW Data (1 GB minimum for Windows Vista)
Hard disk space	Amount required for installation: 450 MB minimum Amount required for operation: 600 MB minimum (When using ImageMixer VCD2 LE for FinePix: 2 GB or better) Minimum 2 GB when converting CCD-RAW Data (must specified in the OS as virtual memory or paging files)
Display	800 × 600 pixels or better, 16-bit color or better (When using ImageMixer VCD2 LE for FinePix: 1024 × 768 pixels or better)
Internet connection*4	<ul style="list-style-type: none">To use the FinePix Internet Service or mail attachment function: An Internet connection or e-mail transmission software is neededConnection speed: 56 k or better recommended

*1 Models with one of the above operating systems pre-installed.

*2 When you install the software, login using a system administrator account (e.g. "Administrator").

*3 Requires Service Pack4 when converting CCD-RAW Data.

*4 Required to use the FinePix Internet Service. The software can still be installed even if you do not have an Internet connection.

■ Recommended system

Operating System	Windows XP	Windows Vista
CPU	2 GHz Pentium 4 or better recommended	3 GHz Pentium 4 or better recommended
RAM	512 MB or better recommended	1 GB or better recommended
Hard disk space	2 GB or better	15 GB or better
Display	1024 × 768 pixels or better, Highest (32 bit)	1024 × 768 pixels or better, Highest (32 bit)
Internet connection	Broadband (ADSL, FTTH, CATV, etc.)	Broadband (ADSL, FTTH, CATV, etc.)

ⓘ CAUTION

- Connect the camera directly to the PC using the USB cable (mini-B). The software may not operate correctly when you use an extension cable or connect the camera via a USB hub.
- When your PC has more than one USB port, the camera can be connected to either port.
- Push the USB connector fully into the socket to ensure that it is securely connected. The software may not operate correctly if the connection is faulty.
- Additional USB interface board is not guaranteed.
- Windows 95, Windows 98 and Windows NT cannot be used.
- Operation is not guaranteed on home-built PCs or on PCs running updated operating system software.
- When you reinstall or remove FinePixViewer, the Internet menu and your user ID and password for the FinePix Internet Service are deleted from your PC. Click the [Register now] button, enter your registered user ID and password and download the menu again.

Continued ➔

Do not connect the camera to your PC until the software installation is completed.

1 Install FinePixViewer as instructed in the Quick start guide.

Launching the installer manually

- ① Double-click the “My Computer” icon.
* Windows XP users should click “My Computer” in the “Start” menu.
Windows Vista users should click “Computer” in the “Start” menu.
- ② Right-click “FINEPIX” (CD-ROM drive) in the “My Computer” window (Windows Vista users: in the “Computer” window) and select “Open”.
- ③ Double-click “SETUP” or “SETUP.exe” in the CD-ROM window.



- * The way file names are displayed differs as described below depending on your PC settings.
 - File extensions (3-letter suffixes indicating the file type) may be shown or hidden. (e.g. Setup.exe or Setup)
 - Text may be shown normally or all in uppercase (e.g. Setup or SETUP).

CHECK

For Windows Vista users:
When loading the bundled CD-ROM on your PC, the “AutoPlay” window may appear. In this case, click “SETUP.exe”.
When “User Account Control” window appears, click “Allow”.

Installing other applications

You may see messages for installing ImageMixer VCD2 LE for FinePix. Install this application as directed by the on-screen instructions.

2 Install DirectX as directed by the on-screen instructions and then restart your PC. If the latest version of DirectX is already installed on your PC, this installation is not performed.

CAUTION

- If the latest version is already installed, this window does not appear.
- Do not remove the CD-ROM during this procedure.

3 After restarting the PC, a message appears stating “Installation of the FinePixViewer has been completed”.

Installation on a Mac OS X

Pre-installation checklist

Hardware and software requirements

To run this software, you must have the hardware and software described below. Check your system before you begin the installation.

Compatible Mac *1	Power Macintosh G3*2, PowerBook G3*2, Power Macintosh G4, iMac, iBook, Power Macintosh G4 Cube, PowerBook G4, Power Macintosh G5, MacBook, MacBook Pro, or Mac mini
Operating System	Mac OS X (compatible with version 10.3.9 to 10.4.8)
RAM	192 MB minimum Minimum 768 MB when converting CCD-RAW Data
Hard disk space	Amount required for installation: 200 MB minimum Amount required for operation: 400 MB minimum (When using ImageMixer VCD2 LE for FinePix: 2 GB or better) Minimum 2 GB when converting CCD-RAW Data (required on the system disk)
Display	800 × 600 pixels or better, at least 32,000 colors (When using ImageMixer VCD2 LE for FinePix: 1024 × 768 pixels or better)
Internet connection *3	<ul style="list-style-type: none">• To use the FinePix Internet Service or mail attachment function: An Internet connection or e-mail transmission software is needed• Connection speed: 56 k or better recommended

*1 PowerPC, Intel processor loaded

*2 Models with a USB port as a standard feature

*3 Required to use the FinePix Internet Service. The software can still be installed even if you do not have an Internet connection.

CAUTION

- Connect the camera directly to the Macintosh using the USB cable (mini-B). The software may not operate correctly if you use an extension cable or connect the camera via a USB hub.
- Push the USB connector fully into the socket to ensure that it is securely connected. The software may not operate correctly if the connection is faulty.
- Additional USB interface board is not guaranteed.

Continued ➔

- 1 Turn your Macintosh on and start up Mac OS X. Do not launch any other applications.**
- 2 When the bundled CD-ROM is loaded into the CD-ROM drive, the “FinePix” icon appears. Double-click the “FinePix” icon to open the “FinePix” volume window.**
- 3 Double-click on “Installer for MacOSX”.**
- 4 The Installer setup dialog appears. Click the [Installing FinePixViewer] button.**

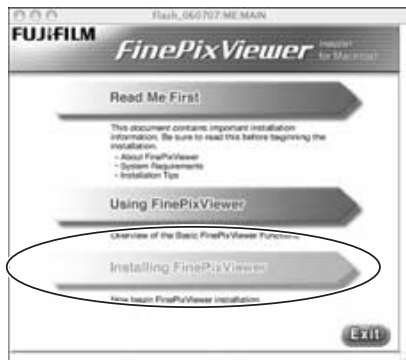

! CAUTION

For more information on what is installed, click the [Read Me First] button and [Using FinePixViewer] button.

- 5 The “Authenticate” dialog appears. Enter the name and password for the administrator account and then click the [OK] button.***

* The administrator account is the user account used for Mac OS X installation and you can confirm the user account in the Accounts dialog in the System Preferences.

- 6 The “License” dialog appears. Read the agreement carefully and then, if you agree to the terms of the Agreement, click the [Accept] button.**

- 7 The “Read me” dialog appears. Click the [Continue] button.**

- 8 The “FinePixInstallIOSX” window appears. Click the [Install] button to install FinePixViewer.**

9 The ImageMixer VCD2 LE for FinePix installer automatically starts up and a window showing the installation progress appears (Installation may take several minutes).

10 The “FinePixViewer installation completed” message dialog appears. Then click exit button and close it.

! **CAUTION**

When Safari is used as the Web browser, a message may be displayed and the CD-ROM may not be removed. If this happens, click the Safari icon in the Dock to make Safari the active application and then select “Quit Safari” in the “Safari” menu to shut down Safari.

11 Launch “Image Capture” from the “Applications” folder.

12 Change the Image Capture settings. Select “Preferences...” from the “Image Capture” menu.

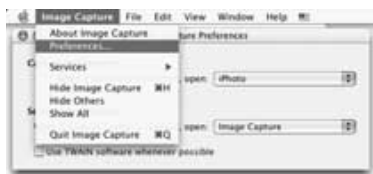

13 Select “Other...” from “When a camera is connected, open”.

14 Select “FPVBridge” from “FinePixViewer” folder in the “Applications” folder and click the [Open] button.



15 Select “Quit Image Capture” menu in the “Image Capture” menu.

Connecting to a PC

By connecting the camera to a PC, your system can be expanded to fill a wide range of uses. Using “FinePixViewer” performs images saving, browsing and file management etc.

MEMO

If the power cuts out during data transmission, the data will not be transmitted correctly. Always use the AC power adapter when connecting the camera to a PC.
When IS Pro is connected to Windows PC, IS Pro is recognized as “FinePix S5 Pro”.

Refer to Software Installation (→p.188, 191) the first time you connect the camera to your PC.

Install the software first. Do not connect the camera to the PC before installing all the software.



CD-ROM
(Software for FinePix CX)

- ① Insert the memory card with images into the camera (→p.34).

CAUTION

- Do not format the memory card in the camera on the PC.
- Use the memory card with images taken by a FUJIFILM Digital camera.
- When connecting to a PC, if the memory card contains large images, connection or transmission may take time or images may not be stored.

- ② Turn the power switch to ON to turn the camera on.

- ③ Select [~~MTP~~MTP(PTP)] for [USB MODE] under [SYSTEM] in the [SET UP] menu.

See “Using the [SET UP] menu” (→p.138).

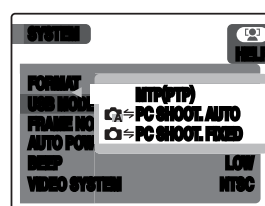

- ④ Turn the power switch to OFF to turn the camera off.
- ⑤ Connect the camera to your PC using the USB cable (mini-B).

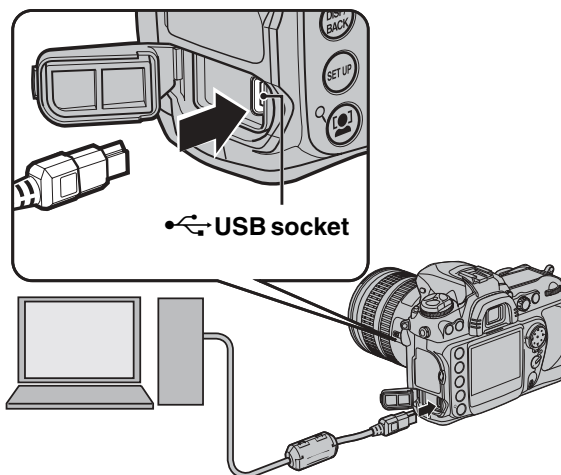

- ⑥ Set the Power switch to ON to turn the camera on.

- If the camera communicates with the PC successfully, **PC** will be displayed in the control panel and viewfinder. Photographs can be transferred to the computer as described in the manual for the supplied software (on CD).



MEMO

See the manuals provided with the supplied software for more information.

! CAUTION

- IS Pro is compatible with MTP/PTP (Picture Transfer Protocol). A MTP/PTP-compatible camera is a camera which can recognize the PC and printer automatically when connected.
- Always use the FUJIFILM AC Power Adapter AC-135VN (sold separately). If the camera suddenly loses power during data exchange, the memory card could be damaged.
- Do not disconnect the USB cable (mini-B) when the camera is communicating with a PC. If disconnecting the USB cable (mini-B) during communication, the files on the memory card may be destroyed.
- In Mac OS X, you must set the automatic setup when the first time you connect the camera to your PC.
- Make sure that USB cable (mini-B) is connected correctly and pushed in.
- Perform pre-arranged steps to disconnect and turn off the camera (→p.197).
- Auto power save is disabled during USB connection.
- Before replacing the memory card, always disconnect the camera from the PC. See p.197 for information on the disconnection procedure.
- The camera and PC may be exchanging data even when “Copying” disappears on your PC screen. Before disconnecting the USB cable (mini-B), always check that the access lamp is off.
- An image taken with CCD-RAW (→p.93) setting is required to be transferred to a PC using FinePixViewer.
- When Windows 98 SE is used, the supplied software must be installed first before connecting the camera to a PC using the USB cable. The PC will not recognize the camera if it is connected before the installation.

Continued ➔

⑦ Set a PC.

Windows 98 SE / Me / 2000 Professional / Macintosh

⚠ CAUTION

The Windows CD-ROM may also be required during installation. In this event, change CD-ROMs as directed by the on-screen instructions.

- FinePixViewer automatically starts up and the Save Image Wizard window (Save Image dialog box) appears. Follow the instructions provided on screen to save the images. To proceed without saving the images, click the [Cancel] button.



* Screen for Windows 2000 Professional

📎 MEMO

- You can only see images saved on a PC. Save images on a PC.
- If you cancel saving by clicking the [Cancel] button, set the power switch to OFF to turn off the camera and then disconnect it from the PC.

Windows XP / Vista

- ① The “Found New Hardware” help message appears in the bottom-right corner of your screen. This message will close when the settings are completed. No action is required.

⚠ CAUTION

This step is not required for subsequent connections.

- ② FinePixViewer automatically starts up and the Save Image Wizard window (Save Image dialog box) appears. Follow the instructions provided on screen to save the images. To proceed without saving the images, click the [Cancel] button.

📎 MEMO

- You can only see images saved on a PC. Save images on a PC.
- If you cancel saving by clicking the [Cancel] button, set the power switch to OFF to turn off the camera and then disconnect it from the PC.

Proceed to “Using FinePixViewer” (→p.198).

Disconnecting the camera

1 Windows

Once the image has been saved, the window below appears (Save Image Wizard window). To disconnect the camera, click the [Remove] button.



Macintosh

Once the image has been saved, the window below appears. To disconnect the camera, click the [OK] button.

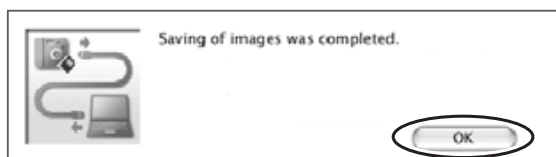

- 2** ① Set the Power switch to OFF to turn the camera off.
② Unplug the USB cable (mini-B) from the camera.

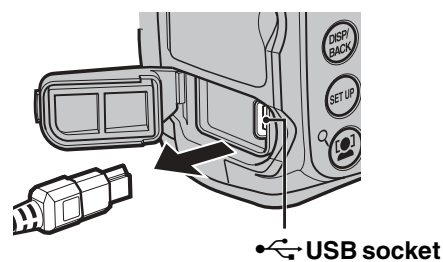

Using FinePixViewer

Mastering FinePixViewer

For all information on FinePixViewer functions, refer to “How to Use FinePixViewer” in the Help menu for details.

- **What is explained in “How to Use FinePixViewer”...** “How to Use FinePixViewer” covers a range of topics, including batch processing and ordering prints.

Example: Looking up slide shows

- ① Click “How to Use FinePixViewer” in the FinePixViewer Help menu.
- ② Click “Basic Operation” and then click “Slide Show” in the menu that appears.
- ③ The “Slide Show” information appears. Press the “<<<” key to view the previous page or the “>>>” key to view the next page.

Uninstalling the software

Only perform this operation when you no longer require the installed software or when the software was not installed correctly.

Windows

- ① Check that the camera is not connected to the PC.
- ② Quit all currently running applications.
- ③ Open the “My Computer” (Windows XP/Vista users should click “Control Panel” in the “Start” menu.) window. Then open the “Control Panel” (Windows Vista users: open the “Programs”) and double-click on “Add/Remove Programs” (Windows Vista users: “Programs and Features”).



- ④ The “Add/Remove Programs Properties” (Windows Vista users: “Programs and Features”) window appears. Select the software to be uninstalled (FinePixViewer or the driver) and then click the [Add/Remove] button (Windows Vista users: [Uninstall/Change] button).

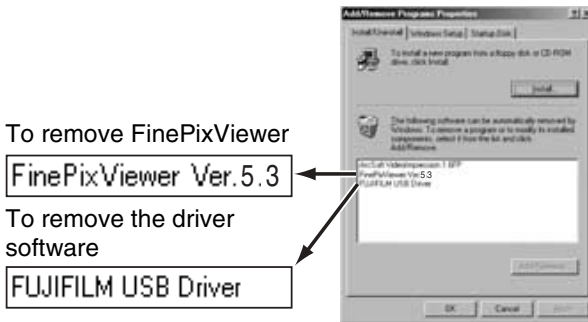

- ⑤ When the message appears, click the [OK] button. Check your selection carefully since the process cannot be canceled once you click the [OK] button.



- ⑥ Automatic uninstallation begins. When uninstallation ends, click the [OK] button.

Macintosh

Quit FinePixViewer. Then drag the installed FinePixViewer folder to the Trash and select “Empty Trash” in the “Finder” menu.

System Expansion Option

By using IS Pro together with other optional accessories, your system can be expanded to fill a wide range of uses. Accessory availability may vary by country. Please check with your local Fujifilm representative to confirm product availability.

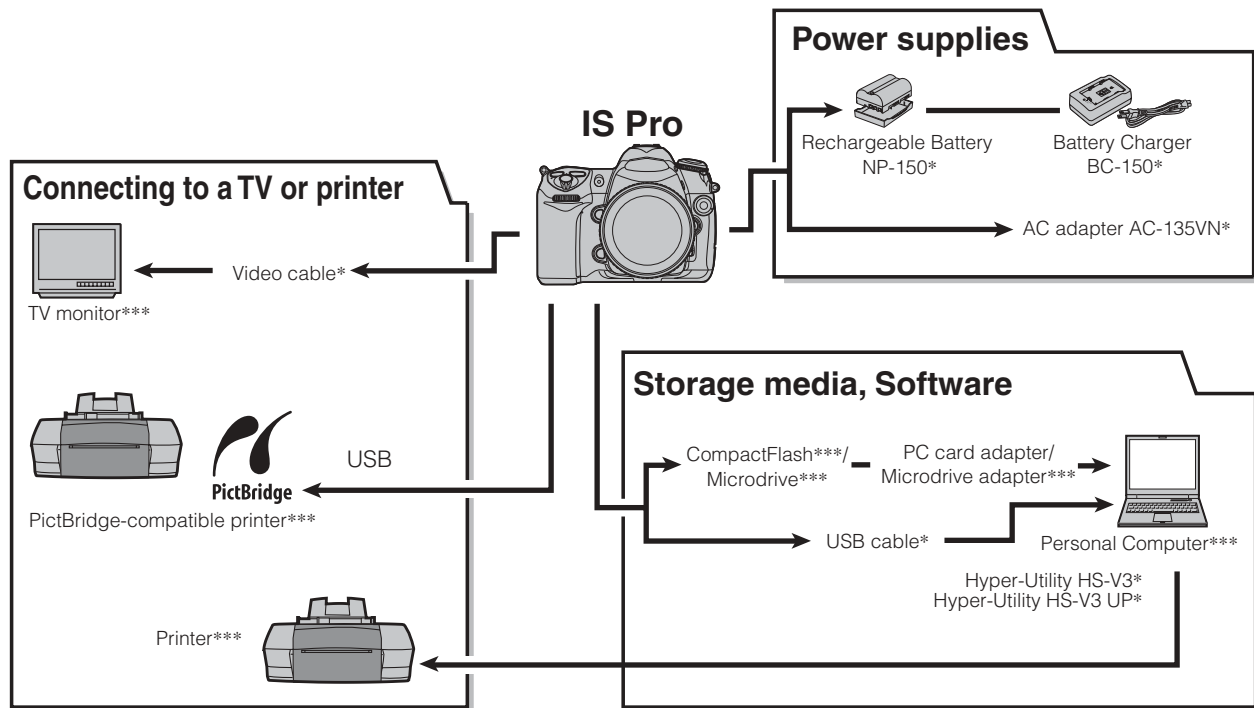

*IS Pro accessories, or sold separately ***Other manufacturer products

Usable Nikon accessories

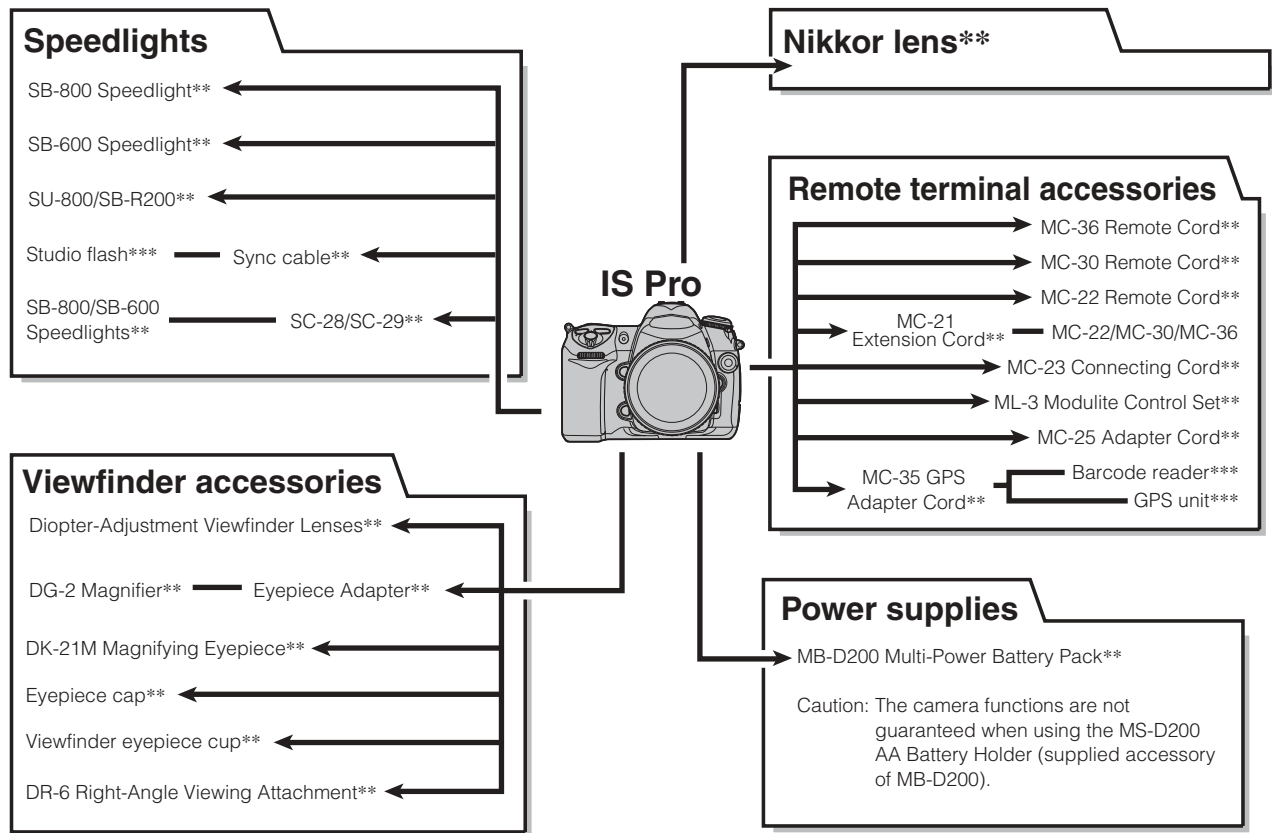

Nikon products *Other manufacturer products

Accessories Guide

Visit the FUJIFILM web site for the latest information on camera accessories.

<http://www.fujifilm.com/products/digital/index.html>

Accessory availability may vary by country. Please check with your local FUJIFILM representative to confirm product availability.

- **Rechargeable Battery NP-150 (1500mAh)**

NP-150 is a rechargeable lithium-ion high capacity battery.

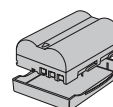

- **Battery Charger BC-150**

Charges the rechargeable battery. The BC-150 reduces charging time to approx. 2 hours and 15min.

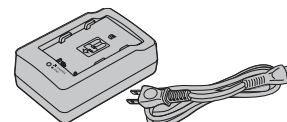

- **AC Power Adapter AC-135VN**

Use the AC-135VN when taking pictures or play back images for long periods or when IS Pro is connected to a PC.

* The shape of the AC power adapter, the plug, and power outlet depend on the country.

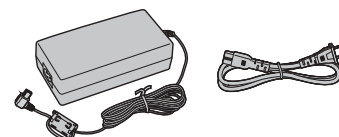



- **Hyper-Utility Software HS-V3**

- Offers PC-based functions such as browsing (includes the Zoom in Face function*1), two-image comparison, image sorting and organizing using a marker, as well as image analysis using a histogram and highlight warning displays for images shot on a digital camera (*1 only the images shot by IS Pro/S5 Pro).

- Allows you to specify the output image size and the processing parameters (tone curve, white balance, sharpness, color and dynamic range*2) for CCD-RAW files and also allows you to convert them to ordinary image files (16-bit/8-bit TIFF or Exif JPEG) (*2 compatible with IS Pro/S5 Pro/S3 Pro/S20 Pro/F710/F700).

- By connecting the camera to a PC, images shot on the camera can be downloaded automatically, or the camera can be controlled from the PC (Shoot from PC function). Compatible with IS Pro*3/S5 Pro/S3 Pro/S2 Pro/S20 Pro.

(*3 When using IS Pro, select S5 Pro.)

*When using Shoot from PC function, select [Control FinePix S5 Pro] from the [Tools] menu or click . Then click , select [FinePix S5 Pro].

- Provides a range of other functions for using photographed images in various ways, including printing, contact-sheet file creation and slide shows.

- Refer to the product package for detailed information on specifications and system requirements.

- **Hyper-Utility Software HS-V3UP**

This product is only for upgrade. The CD-ROM of HS-V2 or HS-S2 is necessary for the installation.

Using Your Camera Correctly

Read this information and the “Safety Notes” (→p.238), to make sure you use your camera correctly.

■ Places to Avoid

Do not store or use the camera in the following types of locations:

- In the rain or in very humid, dirty, or dusty places
- In direct sunlight or in places subject to extreme temperature rises, such as in a closed car in summer
- Extremely cold places
- Places with strong vibration
- Places with smoke or steam
- Places subject to strong electric magnetic fields (such as near broadcasting tower, power lines, radar, motors, transformers, magnets, etc.)
- In contact with chemicals such as pesticides
- Next to rubber or vinyl products

■ Damaged by Water or Sand

IS Pro can be damaged on the inside and outside by water and sand. When you are at the beach or close to water, make sure that the camera is not damaged by water or sand. Take care not to place the camera on a wet surface.

■ Damaged by Condensation

If the camera is carried from a cold location into a warm place, water droplets (condensation) may form on the inside of the camera or on the lens. When this occurs, turn the camera off and wait an hour before using the camera. Condensation may also form on the memory card. In this event, remove the memory card and wait a short time.

■ When the Camera is Not Used or is Stored for Extended Periods of Time

If you do not intend to use the camera for a long period of time, remove the batteries and the memory card.

■ Cleaning Your Camera

- Use a blower brush to remove any dust on the lens, LCD monitor or viewfinder, and then gently wipe the camera with a soft, dry cloth. If any soil remains, apply a small amount of lens cleaning liquid to a piece of FUJIFILM lens cleaning paper and wipe gently.
- Do not scratch hard objects against the lens, LCD monitor or viewfinder.
- Clean the body of the camera with a soft, dry cloth. Do not use volatile substances or cleaning products these items can cause damage.

■ Using the Camera When Traveling

When traveling overseas, do not place your camera in the check-in baggage. Baggage can be subjected to violent shocks, and the camera may be damaged inside or outside.

Cleaning the CCD

This camera is equipped with a CCD photosensitive element. This CCD is located behind the shutter screen. If dust or other soiling attaches to the surface of the CCD and pictures are then taken, this soiling may appear as spots in the image, depending on the camera settings and the type of subject. If this occurs, the CCD must be cleaned. Because the surface of the CCD is extremely fragile, wherever possible the camera should be returned to an authorized FUJIFILM dealer for cleaning (for a charge).

Any repairs carried out by an authorized FUJIFILM dealer to CCDs that were scratched or damaged during cleaning by the customer will be charged to the customer. Note that such repairs will probably involve replacing the CCD and will be expensive.

Dust inside the camera and on the surface of the CCD

- Before a FUJIFILM digital camera is shipped from the factory, it is carefully checked for dust inside the camera and on the surface of the CCD to ensure that it conforms to FUJIFILM standards.
- Bear in mind also that some types of soiling on the CCD surface cannot be removed even by an authorized FUJIFILM dealer. Should this occur, you can use features such as the despeckling function provided in the image processing software to remedy the problem.

Checking the condition of the CCD surface

- ① Select [MIRROR LOCK-UP (CLEANING)] for the [MAINTENANCE] in the [SET UP] menu. See "Using the [SET UP] menu" (→p.138).

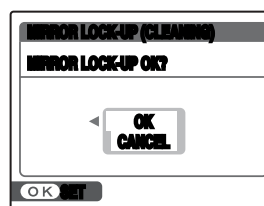

- ② Press ▲ or ▼ to select [OK]



- ③ Press MENU/OK. [- - - - -] is displayed in the control panel.



- ④ Press the shutter button all the way down. The mirror will be raised and the shutter curtain will open, and a row of dashes will blink in the control panel.

- ⑤ Hold the camera so that the sun shines on the CCD and check the surface for dust.

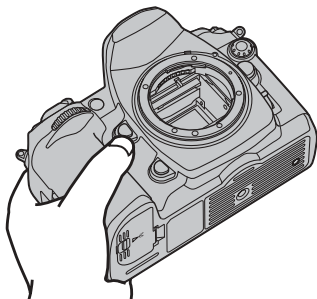

- ⑥ In case of surface clean

→ Turn the camera off and attach the lens cap, or if the lens is detached, attach a body cap to the camera.

In case of surface soiling

→ Contact a FUJIFILM dealer and request CCD cleaning. Or see Starting CCD cleaning (→p.205).

! CAUTION

- Note that this option is not available at battery levels less than  or while shooting multiple exposures.
- When cleaning the camera, always use the full charged battery or AC power adapter AC-135VN (sold separately) to prevent camera damage should the mirror drop or the shutter close.
- If the battery runs low while the mirror is raised, a beep will sound and the AF-assist illuminator will blink to warn that the shutter curtain will close and the mirror will lower in about two minutes. End cleaning or inspection immediately.

MEMO

To return to normal operation without raising the mirror, turn the camera off.

Starting CCD cleaning

Take great care to avoid scratching or damaging the CCD during cleaning, as you will be responsible for the possibly high cost of repairs (or replacement) by an authorized FUJIFILM dealer.

- ① Use a blower (without a brush attached) to remove any soiling on the CCD surface.

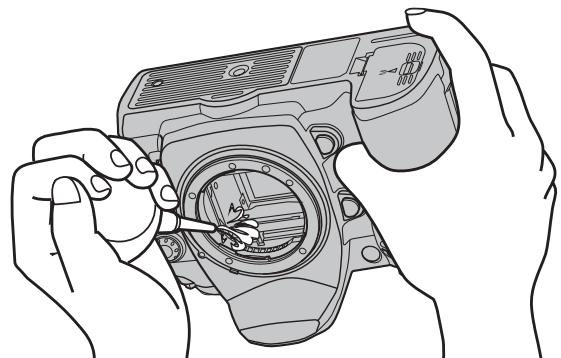

MEMO

Use a blower that does not have a brush attached. Using a blower brush to clean soiling from the CCD can scratch the CCD surface.

Continued →

Cleaning the CCD

- ② Check whether the dust has been removed from the CCD surface.

- The blower has removed the dust (There are no oily marks or fingerprints).
→ Turn the camera off and mount the lens or body cap on the camera.
- There are oily marks or fingerprints left on the CCD that cannot be removed with the blower.
→ Proceed to step③.

! CAUTION

When you turn the camera off, the mirror drops down and the shutter closes at the same time. Ensure that your fingers are not caught inside the camera.

■ Ensure that you have the cleaning equipment ready

- Cleaning swabs
Sensor Swab (Photographic Solutions, Inc.)
* For information on suppliers outside Japan, visit the web site listed below
(<http://www.photosol.com/swabproduct.htm>).
- Cleaning fluid
Anhydrous ethanol

- ③ Moisten the bottom 5 mm (0.2 in) of the Sensor swab evenly with cleaning fluid.

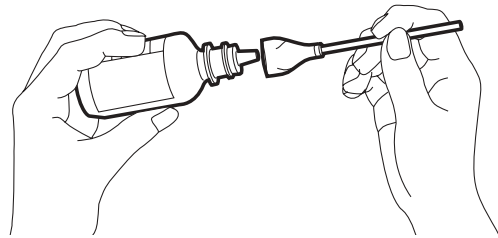

! CAUTION

Do not use the swab when it is dry or not moistened with cleaning fluid.

- ④ Slowly and gently wipe using only one side of the sensor swab just once across the full width of the CCD from left to right.

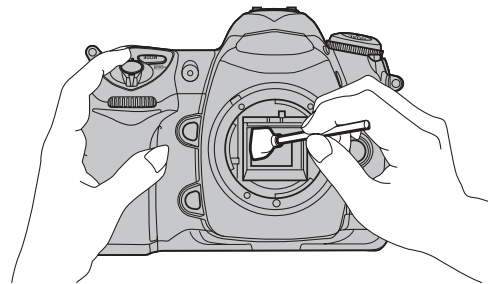

-
- ⑤ Wipe using the other side of the swab across the full width of the CCD from left to right once more. Do not reuse the swab.

! CAUTION

If this does not remove the soiling, repeat steps ③ to ⑤ with a new Sensor swab or contact an authorized FUJIFILM dealer.

- ⑥ Turn the camera off and mount the lens or body cap on the camera.

! CAUTION

- When you turn the camera off, the mirror drops down and the shutter closes at the same time. Take care to ensure that your fingers are not caught inside the camera.
- Always use this procedure to clean the CCD. Never clean the CCD in bulb shooting mode. A current runs through the CCD in bulb shooting mode and cleaning could cause damage.

Power Supply and Battery

Notes on the Battery (NP-150)

This camera uses the rechargeable lithium-ion Battery NP-150. Note the points below when using the rechargeable battery. Take particular care to read the Safety Notes to make sure that you use the battery correctly.

- * When shipped, the NP-150 is not fully charged. Always charge the NP-150 before using it.
- When carrying the NP-150, load it in the digital camera or attach the enclosed battery cap.

Battery Features

- The NP-150 gradually loses its charge even when not used. Use a NP-150 that has been charged recently (in the last day or two) to take pictures.
- To maximize the life of the NP-150, turn the camera off as quickly as possible when it is not being used.
- The number of available frames will be lower in cold locations or at low temperatures. Take along a spare fully charged NP-150.

You can also increase the amount of power produced by putting the NP-150 in your pocket or another warm place to heat it and then loading it into the camera just before you take a picture.

If you are using a heating pad, take care not to place the NP-150 directly against the pad. The camera may not operate if you use a depleted NP-150 in cold conditions.

Charging the Battery

- You can use the battery charger BC-150 (included) to charge the NP-150. When charging, use the NP-150 battery adapter supplied with the BC-150.
- The NP-150 can be charged using the BC-150 Battery Charger at ambient temperatures between 0°C and +40°C (+32°F and +104°F). At an ambient temperature of +23°C (+73°F), it takes approx. 135 minutes to charge a fully depleted NP-150 battery.
- You should charge the NP-150 at an ambient temperature between +10°C and +35°C (+50°F and +95°F). If you charge the NP-150 at a temperature outside this range, charging takes longer because the performance of the NP-150 is impaired.
- The NP-150 does not need to be fully discharged or exhausted flat before being charged.
- The NP-150 may feel warm after it has been charged or immediately after being used. This is perfectly normal.
- Do not recharge a fully charged NP-150.

Battery Life

At normal temperatures, the NP-150 can be used at least 300 times.

If the time for which the NP-150 provides power shortens markedly, this indicates that the NP-150 has reached the end of its effective life and should be replaced.

Notes on storage

The rechargeable lithium-ion battery NP-150 is both compact and capable of storing large quantities of power. However, if it is stored for long periods while charged, the performance of the battery can be impaired.

- If the battery will not be used for some time, run the battery out before storing it.
- If you do not intend to use the camera for a long period of time, remove the battery from the camera.
- Store the battery in a cool place.
- * The battery should be stored in a dry location with an ambient temperature between +15°C and +25°C (+59°F and +77°F).
- * Do not leave the battery in hot or extremely cold places.

■ Handling the Battery

To avoid injury or damage, observe the following:

- Do not carry or store battery with metal objects such as necklaces or hairpins.
- Do not heat the battery or throw it into a fire.
- Do not attempt to take apart or change the battery.
- Do not recharge the battery with chargers other those specified.
- Dispose of used battery promptly.

To avoid damaging the battery or shortening its life, observe the following:

- Do not drop the battery or otherwise subject it to strong impacts.
- Do not expose the battery to water.

To make sure that you obtain optimum battery performance, observe the following:

- Always keep the battery terminals clean.
- Do not store battery in warm or humid places. Storing the battery for long periods in a hot location can shorten the battery life.
- Do not split or peel outer labels of the battery.

If you use the battery for a long period, the camera body and the battery itself will become warm. This is normal. Use an optional AC power adapter if you are taking pictures or viewing images for a long period of time.

■ Specifications of the included NP-150

Nominal voltage	DC 7.2V
Nominal capacity	1500 mAh
Operating temperature	0°C to +40°C (+32°F to +104°F)
Dimensions	39.5 mm × 55.8 mm × 20.9 mm (1.6 in. × 2.2 in. × 0.8 in.) (W × H × D)
Mass (Weight)	Approx. 80 g (2.8 oz.)

Continued ➔

AC Power Adapter

Always use the AC power adapter AC-135VN with the camera.

The use of an AC power adapter other than the AC-135VN can cause damage to your digital camera.

- Use the AC power adapter for indoor use only.
- Plug the connection cord plug securely into the DC input terminal of the FUJIFILM Digital camera.
- Turn off the FUJIFILM Digital camera before disconnecting the cord from the FUJIFILM Digital camera's DC input terminal. To disconnect, pull out the plug gently. Do not pull on the cord.
- Do not use the AC power adapter with any device other than your camera.
- During use, the AC power adapter will become hot to the touch. This is normal.
- Do not take apart the AC power adapter. Doing so could be dangerous.
- Do not use the AC power adapter in a hot and humid place.
- Do not subject the AC power adapter to strong shocks.
- The AC power adapter may emit a humming. This is normal.
- If used near a radio, the AC power adapter may cause static. If this happens, move the camera away from the radio.

Notes on the Memory Card

■ Protecting Your Data

- Images may be lost or destroyed in the following situations. Please note that FUJIFILM assumes no responsibility for data that is lost or destroyed.
 1. Removal of the memory card or turning the power off while the memory card is being accessed (i.e., during record, erase, initialization, and playback operations).
 2. Improper handling and use of the memory card by the user or third party.

! CAUTION

Save your important data to another media (i.e., MO disk, CD-R, hard disk, etc.).

■ Handling Memory card (all types)

- When inserting the memory card into the camera, hold the memory card straight as you push it in.
- Never remove the memory card or turn the camera off during data recording or erasing (memory card formatting) as this could be damaged to the memory card.
- Do not bend, drop or otherwise subject the memory card to strong force or shocks.
- Do not use or store these memory card in places with affected by strong static electricity or electrical noise.
- Do not use or store memory card in hot humid places or in places where they are exposed to corrosive substances.

■ Using CompactFlash

Contact the CompactFlash card manufacturer for information on the CompactFlash functions, operation details and system requirements.

Card types approved for use with the IS Pro are listed on the FUJIFILM website.

<http://home.fujifilm.com/products/digital/>

























- The CompactFlash card may be hot immediately after being used in the camera and should be handled with care.
- Do not touch the card contact area with your fingers or metal objects.
- Unused CompactFlash cards should be formatted before being used.

■ Using memory card with a PC

- When taking pictures using a memory card that has been used on a PC, reformat the memory card using your camera for best quality.
- When formatting a memory card, a directory (folder) is created. Image data is then recorded in this directory.
- Do not change or delete the directory (folder) or file names on the memory card because this will make it impossible to use the memory card in your camera.
- Always use the camera to erase image data on a memory card.
- To edit image data, copy the image data to the PC and edit the copy.
- Do not copy files other than those that will be used by the camera.

Warning Displays

Warning messages displayed in the control panel and viewfinder

Control panel	Viewfinder	Explanation	Remedy
 (blinks)	 (blinks)	Lens aperture ring is not locked at minimum aperture.	Lock ring at minimum aperture (largest f/-number).
		Low battery.	Ready fully-charged spare battery.
 (blinks)	 (blinks)	<ul style="list-style-type: none"> Battery exhausted. Battery information not available. 	<ul style="list-style-type: none"> Exchange with fully-charged spare battery. Battery cannot be used in camera.
		No lens attached, or non-CPU lens attached without specifying maximum aperture. Aperture shown in stops from maximum aperture.	Aperture value will be displayed if maximum aperture is specified.
—	 (blinks)	Camera unable to focus using autofocus.	Focus manually.
		Subject too bright; photo will be overexposed.	<ul style="list-style-type: none"> Choose lower sensitivity. Use optional neutral density (ND) filter. In exposure mode: <ul style="list-style-type: none">  Increase shutter speed  Choose smaller aperture (larger f/-number)
		Subject too dark; photo will be underexposed.	<ul style="list-style-type: none"> Choose a higher sensitivity (ISO equivalency) Use optional Speedlight. In exposure mode: <ul style="list-style-type: none">  Lower shutter speed  Choose a larger aperture (smaller f/-number)
 (blinks)	 (blinks)	 selected in mode  and mode dial rotated to S.	Change shutter speed or select mode  .
 (blinks)	 (blinks)	Nikon Speedlight that does not support i-TTL flash control attached and set to TTL.	Change flash mode setting on optional Speedlight.

Control panel	Viewfinder	Explanation	Remedy
<i>FULL</i> 0 (blinks)	<i>FUL</i> (blinks)	Memory insufficient to record further photos at current settings, or camera has run out of file or folder numbers.	<ul style="list-style-type: none"> • Reduce quality or size. • Delete photographs. • Insert new memory card.
{-E-}	 (blinks) {-E-}	No memory card.	Insert memory card.
<i>Err</i> (blinks)	<i>Err</i> (blinks)	Problem(s) detected while shooting.	Press the shutter button again. Contact your FUJIFILM dealer, if the warning is still displayed, or is displayed frequently.

Warning messages displayed in the LCD monitor

Warning Displayed	Explanation	Remedy
NO CARD	Memory card is not inserted.	Insert a memory card.
CARD NOT INITIALIZED	<ul style="list-style-type: none"> Memory card is not formatted. The memory card contact area is soiled. Camera fault. 	<ul style="list-style-type: none"> Format memory card on the camera (→p.179). Wipe the contact area on the memory card with a soft, dry cloth. It may be necessary to format the memory card (→p.179). If the message still appears, replace the memory card. Contact your FUJIFILM dealer.
CARD ERROR	<ul style="list-style-type: none"> The memory card format is incorrect. Memory card access error. 	<ul style="list-style-type: none"> It may be necessary to format the memory card (→p.179). If the message still appears, replace the memory card. Contact your FUJIFILM dealer.
MEMORY FULL	Memory card is full.	Erase some images in the memory card (→p.53), or use a memory card that has ample free space.
WRITE ERROR	<ul style="list-style-type: none"> The data could not be recorded due to a memory card error or a connection error between the memory card and camera. The image cannot be recorded as it is too large to fit in the available space on the memory card. The memory card is not formatted. 	<ul style="list-style-type: none"> Re-insert the memory card or turn the camera off and then on again. If the message still appears, contact your FUJIFILM dealer. Use a new memory card. Format the memory card on the camera (→p.179).
FRAME NO. FULL	The frame number has reached 999-9999.	<ol style="list-style-type: none"> Insert a formatted memory card into the camera. Set [RENEW] for [FRAME NO.] under [SYSTEM] in the [SET UP] menu. Start taking pictures (The frame number starts from "100-0001"). Set [CONTINUOUS] for [FRAME NO.] under [SYSTEM] in the [SET UP] menu.
READ ERROR	<ul style="list-style-type: none"> The played back file was not recorded correctly. Camera fault. An attempt was made to play back the image that was not recorded on this camera. 	<ul style="list-style-type: none"> This file cannot be played back. Contact your FUJIFILM dealer. The movie and image cannot be played back.

Warning Displayed	Explanation	Remedy
PROTECTED FRAME	An attempt was made to erase a protected file.	Protected files cannot be erased. Remove the protection (→p.132).
NO IMAGE	An attempt was made to playback images from an empty memory card.	It is impossible to playback.
S CANNOT CROP RAW CANNOT CROP	An attempt was made to crop an image whose size is 2304 × 1536 pixels, or an image shot with RAW setting.	The image cannot be cropped.
CANNOT CROP	<ul style="list-style-type: none"> An attempt was made to crop an image shot using a camera other than IS Pro. The image is damaged. 	The image cannot be cropped.
DPOF FILE ERROR	Prints were specified for 1000 or more frames in the DPOF frame settings.	The maximum number of frames for which prints can be specified on the same memory card is 999. Copy the images for which you want to order prints onto another memory card and then specify the DPOF settings.
CANNOT SET DPOF RAW CANNOT SET DPOF	An attempt was made to specify DPOF settings for an image that is not supported by DPOF.	DPOF printing cannot be used with this image format.
COMMUNICATION ERROR	The camera is not connected to a PC or printer.	<ul style="list-style-type: none"> Check that the USB cable (mini-B) is connected correctly. Check that your printer is turned on.
PRINTER ERROR	Displayed for PictBridge.	<ul style="list-style-type: none"> Check that the printer is not out of paper or out of ink. Turn the printer off briefly and then turn it back on. See the user manual supplied with your printer.
PRINTER ERROR RESUME?	Displayed for PictBridge.	Check that the printer is not out of paper or out of ink. Printing automatically restarts when the error is cleared. If the message still appears after checking, press MENU/OK to restart printing.

Continued ➔

Warning Displays

Warning Displayed	Explanation	Remedy
CANNOT BE PRINTED	Displayed for PictBridge.	<ul style="list-style-type: none"> • See the user manual supplied with the printer and check whether the printer supports the JFIF-JPEG or Exif-JPEG image format. If not, the printer cannot print the images. • Images with CCD-RAW cannot be printed. • Was the image data photographed using IS Pro? You may not be able to print some images photographed by other cameras.
CAN NOT USE IN CURRENT SETTING	<ul style="list-style-type: none"> • An attempt was made to make a setting for a multiple exposure picture when [ISO AUTO CONTROL] was [ON]. • An attempt was made to make a setting for a multiple exposure picture when the auto bracketing was active. • An attempt was made to use live view display when the auto bracketing was active. 	<ul style="list-style-type: none"> • Select [OFF] for [ISO AUTO CONTROL] under [ISO AUTO CONTROL] under [<input checked="" type="checkbox"/> EXPOSURE] in the [SET UP] menu (→p.154). • Make a setting for multiple exposure shooting after canceling bracketing (→p.104). • You can use the live view display after canceling bracketing (→p.104).
ERROR	An attempt was made to attach the GPS device when [BCR 1 SHOT] or [BCR CONTINUOUS] is set for the [BARCODE READER/GPS] under [<input checked="" type="checkbox"/> SHOOTING] in the [SET UP] menu	Turn the camera off briefly and set [GPS] for [BARCODE READER/GPS] under [<input checked="" type="checkbox"/> SHOOTING] in the [SET UP] menu. Then, attach the device again.

Troubleshooting

■ Getting ready

Matters	Problems	Possible causes	Solutions	Page
Battery and power supply	The camera is not turned ON when setting the power switch to ON.	The battery has run out.	Charge the battery or load fully charged battery.	30, 32, 208
		The battery is loaded backward.	Load the battery in the correct direction	32
		The battery cover is not closed securely.	Close the battery cover securely.	32
		The camera and AC power adapter are not connected correctly.	Connect the camera and AC power adapter correctly.	210
	Battery runs out quickly.	Camera is used in extremely cold conditions.	Put the battery in your pocket or another warm place to heat it and then load it into the camera just before you take a picture.	30, 33, 208
		The battery terminals are soiled.	Wipe the battery terminals with a clean, dry cloth.	208
		Same battery has been used for a long period.	The battery can no longer be recharged. Load a new battery.	32, 33, 208
	Power cuts out during operation.	The battery has run out.	Charge the battery or load fully charged battery.	30, 32, 208
		The camera and AC power adapter are not connected correctly.	Connect the camera and AC power adapter correctly.	210
		Not usable battery is loaded.	Use the rechargeable battery NP-150.	30, 32

■ Setting menu etc.

Matters	Problems	Possible causes	Solutions	Page
LCD monitor display	Screens are not displayed in English.	A language other than English is selected for [言語/LANG.] under [🕒] TIME · [言語/LANG.] in the [SET UP] menu.	Select ENGLISH.	41

■ Shooting

Matters	Problems	Possible causes	Solutions	Page
Basic operations	No photograph is taken when pressing the shutter button.	The memory card is full.	Insert a new memory card or erase some unnecessary frames.	34, 53, 127
		The memory card is not formatted.	Format the memory card on the camera.	35, 145, 179
		The focus is not set in AF-S mode (focus indicator "●" not lit).	Use AF lock to set the focus and check that the focus indicator "●" is lit before taking the shot.	54, 61
		No memory card.	Insert a memory card.	34
		The camera will not focus.	Set the focusing mode to manual (M), focus on the subject manually and take the picture.	60
		An error occurred.	Refer to the warning displays on P.212-216 and take the appropriate action.	212-216
		The memory card is damaged.	Insert a new memory card.	34
		The battery has run out.	Charge the battery or load fully charged battery.	30, 32, 208
	The Auto power off function has turned the camera off.	Turn the camera on.	36	
Focusing	Camera has difficulty in focusing on the subject.	You are shooting a subject that is not suited to autofocus (→p.63).	Use the focus lock to take the picture.	61

Continued ➔

Troubleshooting

Matters	Problems	Possible causes	Solutions	Page
Flash	Cannot use the flash.	The shutter button was pressed while the flash was charging.	Wait until the charging is completed before pressing the shutter button.	79
		The flash is set to suppressed flash mode. (The flash is closed.)	Raise the built-in flash.	79
		The battery has run out.	Charge the battery or load fully charged battery.	30, 32, 208
	The playback image is dark even though the flash was used.	The subject is too far away.	Move to within the effective flash range before taking the picture.	81
		Your finger was covering the flash.	Hold the camera correctly.	48
Photographed images	The image is blurred.	The lens is dirty.	Clean the lens.	203
		M (Manual) was set for the focus mode when the picture was taken.	Set S (Single-servo AF) or C(Continuous-servo AF) for the focus mode. Or make sharp focus using M (Manual) before taking a picture.	54, 60
		The shutter speed was slow when the picture was taken.	It may cause camera shake. Hold the camera steadily.	–
Recording images	Photographed images are not recorded.	AC power adapter was connected or disconnected during turning the camera on.	Connect or disconnect the AC power adapter only when the camera is off. Failing to turn the camera off first can result in damage to the memory card or malfunctions during PC connection.	210

■ Playing back

Matters	Problems	Possible causes	Solutions	Page
Erasing	The function which erases a frame does not perform.	Some frames may be protected.	Unprotect frame(s).	132
	[ALL FRAMES] under [ERASE] does not erase all frames.			
Frame No.	[CONTINUOUS] under [FRAME NO.] does not function.	You opened the battery cover without turning the camera off when replacing the battery or memory card.	Always turn the camera off when replacing the battery or memory card. Opening the battery cover without turning the camera off may cause the frame number memory to not function.	36

■ Connecting

Matters	Problems	Possible causes	Solutions	Page
Connecting to TV	There is no image on the TV.	The camera is not connected to the TV correctly.	Connect the camera and TV correctly.	182
		"TV" is selected as the TV input.	Set the TV input to "VIDEO".	–
		The video output setting is incorrect.	Change the setting to [NTSC] or [PAL].	138, 145
	The TV image is black and white.	The video output setting is incorrect.	Change the setting to [NTSC] or [PAL].	138, 145
Connecting to PC	PC does not recognize the camera.	The USB cable (mini-B) is not correctly connected to the PC or camera.	Set up the camera, and connect the USB cable (mini-B) correctly.	194

Continued ➔

Troubleshooting

Matters	Problems	Possible causes	Solutions	Page
Connecting to printer	Cannot print with PictBridge.	The USB cable (mini-B) is not correctly connected to the printer or camera.	Set up the camera, and connect the USB cable (mini-B) correctly.	183
		The printer is not turned on.	Turn the printer on.	–

■ Others

Matters	Problems	Possible causes	Solutions	Page
Camera operation etc.	Nothing happens when pressing the buttons on the camera.	Camera malfunction may be caused temporarily.	Briefly remove the battery or disconnect the AC power adapter. Then reload the battery or reconnect the AC power adapter and try again.	32, 210
		The battery has run out.	Charge the battery or load fully charged battery.	30, 32, 208
		Camera functions are locked by the function lock.	Unlock the function lock.	169
	The camera no longer works correctly.	Camera malfunction may be caused temporarily.	Briefly remove the battery or disconnect the AC power adapter. Then reload the battery or reconnect the AC power adapter and try again. If you think the camera is faulty, contact your FUJIFILM dealer.	32, 210

Specifications

System	
Model	Digital camera IS Pro
Effective pixels	12.34 million (S-pixel: 6.17 million, R-pixel: 6.17 million) pixels
CCD	Large-format (23.0 × 15.5 mm) Super CCD SR Pro with primary color filter Total 12.9 megapixels (S-pixels: 6.45 million; R-pixels: 6.45 million)
Storage media	CF card and Microdrive™ (FAT32-compatible) (Compatibility is listed on Fujifilm website: http://home.fujifilm.com/products/digital/)
File format	DCF-compliant Compressed: Exif Ver.2.2 JPEG, DPOF-compatible Uncompressed: CCD-RAW (RAF)*1
Number of recorded pixels	4256×2848 / 3024×2016/2304×1536
File size	See the table on the p.226
Lens mount	Nikon F mount (with AF coupling and AF contacts)
Sensitivity	Auto, ISO 100/125/160/200/250/320/400/500/640/800/1000/1250/1600/2000/2500/3200*2 (Standard Output Sensitivity)
Metering modes	TTL open metering/3D 1005-pixel RGB matrix, Center-weighted, Spot
Exposure control	Program AE, Shutter-priority AE, Aperture-priority AE, Manual exposure
Exposure compensation	-5.0 EV to +5.0 EV 1/3, 1/2, 1 EV step
Shutter	Electronically controlled vertical-travel focal-plane shutter
Shutter speeds	30 to 1/8000 sec, Bulb X contact: Max. 1/250 sec.*3
Auto bracketing	Number of shots 2-9 compensated EV value 1/3 1/2 2/3 1 EV step
Focus	Mode: Single-AF servo, Continuous AF servo, Manual AF system: TTL phase difference detection with auxiliary AF flash AF frame selection: Single-area AF, Dynamic-area AF, Group dynamic AF, Dynamic-area AF with closest subject priority

Continued ➔

Specifications

System	
White balance	Automatic scene recognition, Fine, Flash, Shade, Fluorescent(1-5), Incandescent, Choose color TEMP., Preset custom(1-5) *Can be fine tuned.
Self-timer	20 sec./10 sec./5 sec./2 sec.
Flash	Manual pop-up, i-TTL balanced fill-flash for digital SLR, standard i-TTL flash for digital SLR, Guide No.: 12 (ISO 100-m); Sync. shutter speed: 1/250 sec. or slower
Flash modes	Front Synchro, Slow Synchro, Rear synchro, Red-eye Reduction and Red-eye Reduction Slow Synchro
Accessory shoe	Standard ISO-type with hot-shoe contact (Safty lock provided)
Synchro contacts	X contacts only, synchronizing speed: 1/250 sec. or slower
Synchro terminal	Equipped with ISO 519 synchro terminal as standard, lock screw provided
Viewfinder	Eye-level pentaprism (coverage: Approx. 95% vertical and horizontal), dioptic adjustment mechanism, viewfinder magnification approx. 0.94x)
LCD monitor	2.5-inch 230,000-pixels low-temperature polysilicon TFT color LCD panel (approx. 100% coverage for playback)
Remote release	10-pin remote release terminal provided.
Photography functions	Color space selection, dynamic range selection, film simulation mode selection, framing guideline, frame no. memory, multiple exposure shooting, live image
Playback functions	Cropping, slide show, multi-frame playback, histogram display, brightness warning display
Other functions	PictBridge compatibility, Exif Print compatibility, PRINT Image Matching II compatibility, language selection (日本語, English, Francais, Deutsch, Español, Italiano, 中文簡, 繁體, 한글), time difference

Input/Output Terminal

Video output	NTSC/PAL-type
Digital interface	USB 2.0 High-Speed, MTP/PTP (Picture Transfer Protocol)
DC input socket	AC Power Adapter AC-135VN (sold separately)

Power Supply and Others

Power supply	Use one of the following: Rechargeable Battery NP-150 (included) AC Power Adapter AC-135VN (sold separately)
---------------------	--

Guide to the number of available frames for battery operation

Battery Type	With LCD monitor OFF
NP-150 (1500 mAh)	Approx.400 frames

According to the CIPA (Camera & Imaging Products Association) standard procedure for measuring digital still camera battery consumption (extract):
Using the battery supplied with the camera and AF50mm/F1.4D lens. The storage media should be CompactFlash card.

Pictures should be taken at a temperature of +23°C (+73°F), shoot every 30 seconds with the AF-moved for each shot, the flash used at full power every second shot and the camera turned off and then on again once every 10 shots.

- Note: Because the number of available shots varies depending on the level of charge in the battery, the figures shown here for the number of available shots using the battery is not guaranteed. The number of available shots will also decline at low temperatures.

Camera dimensions (W/H/D) 147 mm × 113 mm × 74 mm/5.8 in. × 4.4 in. × 2.9 in. (not including accessories and attachments)

Camera mass (weight) Approx. 830 g/29.3 oz. (not including accessories, battery and memory card)

Operating Conditions Temperature: 0°C to +40°C (+32°F to +104°F)
80% humidity or less (no condensation)

*1 CCD-RAW is a format specific to the IS Pro. The enclosed "FinePixViewer" software or the optional Hyper-Utility software "HS-V3" is required to interpret images.

*2 Images shot in high-sensitivity photography may appear coarse and may also be affected by noise such as white dots.

*3 Images shot with long exposures may appear coarse and may also be affected by noise such as white dots.

Continued ➔ 225

Specifications

■ Memory card capacity and image quality/size

The following table shows the approximate number of pictures that can be stored on a 1 GB memory card at different quality and size settings.

Exposure mode *M*, ISO200, focus mode M, [IMAGE DISPLAY] set to [OFF], [QUICK PREVIEW DATA] set to [ON], SanDisk SDCFX (Extreme III) series card

[D-RANGE] set to [100%(STD)]

Image quality	Image size	File size	No. of images	Buffer capacity	Minimum shooting interval
RAW+FINE	L	approx.18.1MB	55	approx.20	Max. 3 frames/sec.
	M	approx.16.3MB	61	approx.21	
	S	approx.15.1MB	66	approx.21	
RAW+NORMAL	L	approx.15.7MB	63	approx.21	
	M	approx.14.8MB	67	approx.21	
	S	approx.14.2MB	70	approx.21	
RAW	–	approx.12.8MB	78	approx.24	
FINE	L	approx.5.3MB	189	approx.29	
	M	approx.3.5MB	285	approx.39	
	S	approx.2.2MB	442	approx.51	
NORMAL	L	approx.2.9MB	345	approx.30	
	M	approx.2.0MB	495	approx.71	
	S	approx.1.4MB	718	approx.80	

[D-RANGE] set to WIDE (other than [100%(STD)])

Image quality	Image size	File size	No. of images	Buffer capacity	Minimum shooting interval
RAW+FINE	L	approx.30.3MB	32	approx.8	Max. 1.6 frames/sec.
	M	approx.28.6MB	34	approx.8	
	S	approx.27.3MB	36	approx.8	
RAW+NORMAL	L	approx.28.0MB	35	approx.8	
	M	approx.27.1MB	36	approx.8	
	S	approx.26.5MB	37	approx.8	
RAW	–	approx.25.1MB	39	approx.10	
FINE	L	approx.5.3MB	189	approx.19	
	M	approx.3.5MB	285	approx.73	
	S	approx.2.2MB	442	approx.100	
NORMAL	L	approx.2.9MB	345	approx.19	
	M	approx.2.0MB	495	approx.90	
	S	approx.1.4MB	718	approx.100	

 **MEMO**

- When [OFF] is set for the [QUICK PREVIEW DATA] under [ SHOOTING] in the [SET UP] menu, File size decreases, and then No. of images and Buffer capacity differs from the value denoted above.
- No. of images varies depending on the scene recorded and the make of memory card.
- Buffer capacity decreases when [IMAGE DISPLAY] is set to [CONTINUOUS], [4 SEC] or [2 SEC].

* These specifications are subject to change without notice. FUJIFILM shall not be held liable for damages resulting from errors in this Owner's Manual.

* The LCD monitor on your digital camera is manufactured using advanced high-precision technology. Even so, small bright points and anomalous colors (particularly around text) may appear on the monitor. These are normal display characteristics and do not indicate a fault with the monitor. This phenomenon will not appear on the recorded image.

* The operation error may be caused in a digital camera by the strong radio interference (i. e. electric fields, static electricity, line noise, etc.).

Explanation of Terms

EV

A number denotes Exposure Value. The EV is determined by the brightness of the subject and sensitivity (speed) of the film or CCD. The number is larger for bright subjects and smaller for dark subjects. As the brightness of the subject changes, a digital camera maintains the amount of light hitting the CCD at a constant level by adjusting the aperture and shutter speed. When the amount of light striking the CCD doubles, the EV increases by 1. Likewise, when the light is halved, the EV decreases by 1.

JPEG

Joint Photographic Experts Group

A file format used for compressing and saving color images. The higher the compression rate, the greater the loss of quality in the decompressed (restored) image.

Smear

A phenomenon specific to CCDs whereby white streaks appear on the image when there is a very strong light source, such as the sun or reflected sunlight, in the photography screen.

White Balance

Whatever the kind of the light, the human eye adapts to it so that a white object still looks white. On the other hand, devices such as digital cameras see a white subject as white by first adjusting the color balance to suit the color of the ambient light around the subject. This adjustment is called matching the white balance.

CCD-RAW

This is the image data prior to signal processing (the reconstruction of the data read in from the CCD as an image). Because the signal processing is performed on the computer, high levels of control are possible.

* To reconstruct images, FinePixViewer (on the enclosed CD-ROM) or the Hyper Utility (optional) must be installed on your computer.

Color Temperature

A low-temperature light source, such as a candle flame, is strongly red, while a high-temperature light source, such as a gas burner flame, is strongly blue. The color of the light for these temperatures is expressed as a color temperature (K = Kelvin). The light of the sun at midday in a completely clear sky is taken to be 5500K.

Adobe RGB (1998)

A color space introduced as the working color space for Adobe Photoshop 5.0. AdobeRGB encompasses almost all the colors reproduced by CMYK printers and is intended primarily for printing applications. It was introduced as "SMPTE-240E" in the RGB settings in Adobe Photoshop 5.0 and as "Adobe RGB (1998)" in the profile settings from version 6.0 onwards.

Color space

Refers to the range of colors, expressed as two-dimensional or three-dimensional numerical values, that can be reproduced by devices such as cameras, monitors and printers. The sRGB and AdobeRGB color spaces are each shown as an xy color chart (a coordinate color space in which colors are represented in two dimensions with no brightness value). The range of colors that can be expressed by a particular color space is indicated by a triangle imposed on the xy color chart. Colors become brighter as they approach the outer edge of the xy color chart. This color representation method is capable of showing all the actual colors.



Exif Print Format is a newly revised digital camera file format that contains a variety of shooting information for optimal printing.

FUJIFILM Digital Camera Worldwide Network

If you have technical questions or if you need repair service, ask the following local distributor.

Please present the warranty card and your purchase receipt when you ask for repairs. Refer to the warranty card for conditions of the warranty.

There is a case that repair and Technical support cannot be accepted for some models which your local distributor does not deal with.

These lists are subject to change without notice.

NORTH AMERICA		
Canada	FUJIFILM Canada Inc.	600 Suffolk Court Mississauga Ontario, L5R 4G4
	Technical support	TEL 1-866-818-FUJI (3854) http://www.fujihelp.ca
	Repair service	600 Suffolk Court Mississauga Ontario, L5R 4G4
		TEL 1-800-263-5018 FAX 1-905-755-2993 http://www.fujihelp.ca
U.S.A.	FUJIFILM U.S.A., Inc.	1100 King George Post Rd., Edison, NJ 08837
	Technical support	TEL 800-800-3854 FAX 732-857-3487 digitalinfo@fujifilm.com
	Repair service	1100 King George Post Rd., Edison, NJ 08837
		TEL 732-857-3000 FAX 732-857-3471 njcamerarepair@fujifilm.com
Hawaii	FUJIFILM Hawaii, Inc.	94-468 Akoki Street, Waipahu, HI. 96797
	Technical support & Repair service	TEL 1-808-677-3854, ext. 209 FAX 1-808-677-1443 kurt_kmett@fujifilmhawaii.com
CENTRAL & SOUTH AMERICA		
Argentina	Imagen e informacion S.A.	Fondo de la Legua 936 San Isidro Pcia. de Buenos Aires
	Technical support & Repair service	TEL +54-11-4836-1000 FAX +54-11-4836-1144 servtec@imagineinformacion.com.ar
Bolivia	Reifschneider Bolivia Ltda.	Calle H N.º 5 - Equipetrol Norte - Santa Cruz
	Technical support & Repair service	TEL +591 33 44 1129 FAX +591 33 45 2919 gciagral@bibosi.scz.entelnet.bo
Brazil	FUJIFILM do Brasil Ltda.	Av. Vereador José Diniz, 3400 - Campo Belo, São Paulo/SP
	Technical support & Repair service	TEL 0800-12-8600 FAX +55 11 5091-4150 camarasdigitais@fujifilm.com.br
Chile	Reifschneider SA	Av. El Conquistador del Monte 5024, Huechuraba, Santiago, Chile
	Technical support & Repair service	TEL 02-4431500 FAX 02-4431596 ceciliacalvo@reifschneider.cl
Colombia	Animex de Colombia Ltda.	Calle 44 N.º 13-43 Piso 2 Apartado 18001 - Bogotá
	Technical support & Repair service	TEL +57 1 338-0299 FAX +57 1 288-2208 animex@etb.net.co
Ecuador	Espacri Cia Ltda	Bolívar 5-69 y Hermano Miguel
	Technical support & Repair service	TEL 593-72-835526 FAX 593-72-833157

Ecuador	Importaciones Espacri Cia. Ltda. Technical support & Repair service	Simón Bolívar 5-69 y Hno. Miguel - Cuenca TEL +593 783 5526 FAX +593 783 3157 portiz@fujifilm.com.ec
Mexico	Fujifilm de Mexico, S.A. de C.V. Technical support Repair service	Av. Ejercito Nacional 351, Col. Granada 11520 Mexico, D.F. TEL (52-55) 5263-5566 / 68 FAX (52-55) 5254-1508 jlgiraud1@fujifilm.com.mx Av. Presidente Juarez 2007, Col. Tepetlaco, 54090 Tlalnepantla, Edo. de Mexico TEL (52-55) 5263-5500 FAX (52-55) 5254-1508 jlgiraud1@fujifilm.com.mx
Paraguay	Errece S.R.L. Technical support & Repair service	Edificio Unitas 15 de Agosto 1035, Asunción TEL +595 21 444256 FAX +595 21 444651 jmarbulo@fujifilm.com.py
Peru	Procesos de Color S.A. Technical support & Repair service	Pablo Bermudez 111 Apartado 3794 - Esq. Arequipa - Lima 11 TEL +51 14 33 5563 FAX +51 14 33 7177 jalvarado@fujifilm.com.pe
Uruguay	Fotocamara S.R.L. Technical support & Repair service	Cuareim 1439, montevideo, Uruguay TEL +598-2-9002004 FAX +598-2-9008430 fotocam@adinet.com.uy
Uruguay	Kiel S.A. Technical support & Repair service	Maldonado 1787 Montevideo- Uruguay TEL (05982) 419 4542 FAX (05982) 412 0046 kiel@fujifilm.com.uy
Venezuela	C. Hellmund & Cia Sa Technical support & Repair service	Av. Ppal Diego Cisneros Caracas Venezuela Edf Oficentro TEL 0212-2022300 FAX 0212-2399796 hellmund@hellmund.com

EUROPE

Austria	Fuji Film Oesterreich Technical support & Repair service	Traviatagasse/Pfarrgasse, 1230 Vienna, Austria TEL 0043 1 6162606/51 or 52 FAX 0043 1 6162606/58 kamera.service@fujifilm.at
Belgium	Belgian Fuji Agency Technical support & Repair service	20, Avenue Lavoisier, Wavre, 1300, Belgium TEL 3210242090 FAX 3210238562 info@fuji.be
Croatia	I&I d.o.o. Technical support Repair service	Hondlova 2, Zagreb, Croatia TEL 38512319060 FAX 2310240 dsaravanja@fujifilm.hr Hondlova 2, Zagreb, Croatia TEL 38512316228 FAX 2310240 info@fujifilm.hr
Cyprus	PMS IMAGING LTD Technical support & Repair service	11, Dighenis Akritas Avenue, P.O.BOX 22315, 1586 Nicosia TEL 35722746746 FAX 35722438209 mariosashiotis@fujifilm.com.cy

FUJIFILM Digital Camera Worldwide Network

Cyprus	Doros Neophytou CAMERA REPAIRS Technical support & Repair service	28B, Agiou Demetriou, Acropoli, Nicosia TEL 35722314719 FAX 35722515562 dorosn@logosnet.cy.net
Czech Republic	Fujifilm Cz., s.r.o. Technical support	U nakladoveho nadrazi 2/1949, 130 00 Praha 3 TEL 00420 234 703 411 FAX 00420 234 703 489 fricman@fujifilm.cz
Czech Republic	AWH servis Repair service	Milesovska 1, 130 00 Praha 3, Czech republic TEL 00420 222 721 525 FAX 00420 222 720 122 awh@awh.cz
Denmark	Fujifilm Denmark A/S Technical support & Repair service	Stubbeled 2, 2950 Vedbæk Denmark TEL 0045 45662244 FAX 0045 45662214 fujifilm@fujifilm.dk
Finland	Fuji Finland Oy Technical support & Repair service	Martinkyläntie 41, 01720 Vantaa, Finland TEL +358 9 825951 FAX +358 9 870 3818 fuji@fuji.fi
France	FUJIFILM France Technical support & Repair service	2, Avenue Franklin, 78186 Saint-Quentin en Yvelines, France FAX 33 1 01 30 58 58 65 direction.technique@fujifilm.fr
Germany	FUJIFILM Europe GmbH Technical support & Repair service	Heesenstr. 70, 40549 Düsseldorf International call TEL +49 211 50890 FAX +49 211 5089668 service@fujifilm.de National call* TEL 0180 5898980 FAX 0180 5898982 *12 Cent/Min aus dem deutschen Festnetz
Greece	FUJIFILM HELLAS S.A. Technical support & Repair service	1, Ihou & Ag. Anargiron str., 175 64 P.Phaliro, Athens, Greece TEL 0030 210 9404100 FAX 0030 210 9404397 fujifilm@fujifilm.gr
Hungary	Fujifilm Hungary Ltd. Technical support	Váci ut 19, Budapest, 1134, Hungary TEL 3612389410 FAX 3612389401 fujifilm@fujifilm.hu
Iceland	Icephoto (Ljosmyndavorur) Technical support & Repair service	Skipholt 31, 105 Reykjavik, Iceland TEL 354 568 0450 FAX 354 568 0455 framkollun@fujifilm.is
Italy	FujiFilm Italia S.p.A. Technical support Repair service	Via Dell'Unione Europea, 4 - 20097 San Donato Milanese (MI), Italy TEL 039-02895821 FAX 039-0289582912 info@fujifilm.it Fujifilm On Line - Call center TEL 039-026695272 info@fujifilm.it
Lithuania	Fujifilm Lithuania Technical support & Repair service	Gerosios Vilties str. 38, LT-03143 Vilnius, Lithuania TEL 370-5-2130121 FAX 3705-5-2134066 info@fujifilm.lt

Malta	Ciancio (1913) Co.Ltd. Technical support & Repair service	Fuji Tech Centre, Ciancio House, Cannon Road, Qormi, QRM05 TEL 0356-21-480500 FAX 0356-21-488328 info@fujifilm.com.mt
Netherlands	Fujifilm Nederland BV Technical support	Hoogstraat 39, 3011 PE, Rotterdam, The Netherlands TEL 010-2812345 FAX 010-2812334 fuji@fujifilm.nl
	Repair service	Hoevenseweg 43, 4877 LA, Etten-Leur, The Netherlands TEL 010-2812345 FAX 076-7502641 reparatie@fujifilm.nl
Norway	Fujifilm Norge AS Technical support	Lilleakerveien 10, 0283 Oslo, Norway TEL 0047-22736000 FAX 0047-22736020 http://www.fujifilm.no/ mailto:post@fujifilm.no
	Repair service	Liaveien 1, 5132 Nyborg, Norway TEL 0047-55393880 FAX 0047-55195201 http://www.camera.no/ mailto:service@camera.no
Poland	Fujifilm Polska Distribution Sp. z o.o. Technical support	Poland Al..Jerozolimskie 178; 02-486 Warszawa TEL +48-22-517-66-00 FAX +48-22-517-66-02 fujifilm@fujifilm.pl
	Repair service	Poland, Muszkieterow 15, 02-273 Warszawa TEL +48-22-886-94-40 FAX +48-22-886-94-42 serwis@fujifilm.pl
Portugal	Fujifilm Portugal, Lda Technical support	Av. Fontes Pereira de Melo, 342, 4100-259 Porto, Portugal TEL (351) 226194200 FAX (351) 226194213 finepix@fujifilm.pt
	Repair service	Av. Fontes Pereira de Melo, 342, 4100-259 Porto, Portugal TEL (351) 226194200 FAX (351) 225194662 cameras@fujifilm.pt
Romania	CTS-Cardinal Top Systems Ltd Technical support & Repair service	112, Calea Dorobanti street, 4 flat, 1sector, Bucharest, Romania TEL 4021-230-09-82 FAX 4021-230-09-82 cts_tirla@hotmail.com
Russia	ZAO "Fujifilm RU" Technical support	Bld. 1, 10, Rozanova str., Moscow, 123007, Russia TEL +7-095-956-9858 FAX +7-095-230-6217 info@fujifilm.ru
	Repair service	18, Shelepikhinskaya Naberezhnaya str., Moscow, 123290, Russia TEL +7-095-797-3434 FAX +7-095-797-3434
Slovakia	Fujifilm Slovakia Technical support	Pribylinska 2, 831 04 Bratislava, Slovakia TEL 00421 2 44 888 077 FAX 00421 2 44 889 300 fujifilm@fujifilm.sk
	Repair service	FIS Tatracentrum, Hodzovo nam. 4 - Tatracentrum, 811 06 Bratislava, Slovakia TEL 00421 2 54 647 347 fis.tatracentrum@stonline.sk
Spain	Fujifilm España S.A. Technical support	Aragón 180, 08011 Barcelona (España) TEL 902012535 FAX 934515900 / 933230330 info@fujifilm.es
	Repair service	Aragón 180, 08011 Barcelona (España) TEL 934511515 FAX 934515900 / 933230330 tallersat@fujifilm.es

FUJIFILM Digital Camera Worldwide Network

Sweden	Fujifilm Sverige AB	Sveavägen 167 104 35 Stockholm
	Technical support	TEL 46 8 506 141 70 FAX 46 8 506 142 09 kamera@fujifilm.se
	Repair service	Sveavägen 167 104 35 Stockholm
		TEL 46 8 506 513 54 FAX 46 8 506513 54 kameraverkstaden@fujifilm.se
Switzerland / Lichtenstein	Fujifilm (Switzerland) AG	Niederhaslistrasse 12, 8157 Dietlikon, Switzerland
	Technical support & Repair service	TEL +41 44 855 5154 FAX +41 44 855 5329 RepairCenter@fujifilm.ch
Turkey	Fujifilm Turkiye Sinfo A.S.	Fujifilm Plaza, Dereboyu Cad. 39 34660 Halkali, Istanbul, Turkey
	Technical support	TEL +90 212 696 5090 FAX +90 212 696 5009 csarp@fujifilm.com.tr
	Repair service	Fujifilm Plaza, Dereboyu Cad. 39 34660 Halkali, Istanbul, Turkey
		TEL +90 212 696 5090 FAX +90 212 696 5010 servis@fujifilm.com.tr
U.K.	FUJIFILM UK Ltd.	St Martins Way St Martins Business Centre Bedford MK42 0LF
	Technical support	TEL +44 (0)123 424 5383 FAX +44 (0)123 424 5285 fujitec@fuji.co.uk
	Repair service	St Martins Way St Martins Business Centre Bedford MK42 0LF
		TEL +44 (0)123 421 8388 FAX +44 (0)123 424 5285 fujitec@fuji.co.uk
Ukraine	Image Ukraine CJSC	12, Kontraktova ploshcha, Kyiv 04070, Ukraine
	Technical support & Repair service	TEL +380-44-4909075 FAX +380-44-4909076 d@fujifilm.ua
MIDDLE EAST		
Iran	Tehran Fuka Co.	229, "Fuji" Bldg., Mirdamad Blvd., Tehran 19189, Iran
	Technical support & Repair service	TEL (+98-21)2254810-19 FAX (+98-21)2221002 fuka@neda.net
Israel	Shimone Group Ltd.	Efal 33 keyriat Arie Petah Tikva 49130, Israel
	Technical support	TEL (+) 972 3 9250666 digital@fujifilm.co.il
	Repair service	Efal 33 keyriat Arie Petah Tikva 49130, Israel
		TEL (+) 972 3 9250666 FAX 972 3 9250699 khaim@shimone.com
Jordan	Grand Stores	Al- Abdali, Amman / Jordan
	Technical support & Repair service	TEL 009626-4646387 FAX 009626-4647542 gstores@go.com.jo
Qatar	Techno Blue	Blue Salon Bldg, 3rd Floor, Suhaim bin Hamad st, Al- Saad, Doha
	Technical support	TEL 00974 44 66 175 FAX 00974 44 79 053 prabu@techno-blue.com
Saudi Arabia	Emam Distribution Co. Ltd.	P.O. Box 1716, Jeddah 21441, Saudi Arabia
	Technical support	TEL 96626978756 FAX 96626917036 service@fujifilm.com.sa

Syria	Film Trading Company Technical support Repair service	Al-Shahbandar P.O. Box:31180 Damascus SYRIA TEL + 963 11 2218049 FAX + 963 11 44673456 f.t.c@Net.SY Al-cheikh Taha P.O. Box: 6171 Aleppo SYRIA TEL + 963 21 4641903 FAX + 963 21 4641907 filmtradin@Net.SY
U.A.E.	Grand Stores Technical support & Repair service	P. O. Box 2144, Saleh Bin Lahej Building, Al Garhoud, Deira, Dubai TEL + 971-4-2823700 FAX + 971-4-2828382 photography@grandstores.ae
Yemen	Al-Haidary Trading Technical support Repair service	P.O.Box-2942 Haddah St. HTC, Sana'a, Yemen TEL 00967-1-503980 FAX 00967-1-503983 P.O.Box-2942 Haddah St. HTC, Sana'a, Yemen TEL 00967-1-503977 FAX 00967-1-503983
AFRICA		
Egypt	Foto Express Egypt Technical support & Repair service	426 Pyramids St., Giza, Egypt TEL (202) 7762062 FAX (202) 7760169 fotoegypt@access.com.eg
Kenya	Fuji Kenya Ltd Repair service	P.O.Box 41669-00100, Fuji Plaza, Chiromo Road, Nairobi, Kenya. TEL (254-20)4446265-8 FAX (254-20)4448515 / 7 info@fujifilm.co.ke
OCEANIA		
Australia	FUJIFILM Australia Pty Ltd Technical support & Repair service	Locked Bag 5100, Brookvale, NSW, 2100 TEL 1800 226 355 FAX +61 (2) 9466 2854 digital@fujifilm.com.au
Fiji	Brijlal & Co. Ltd Technical support & Repair service	70-72 Cumming Street, Suva, Fiji TEL (679)3304133 FAX (679)3302777 kapadia@connect.com.fj
New Caledonia	Phocidis SARL Technical support & Repair service	58, rue Higginson - B.P.661 - 98845 TEL (00 687) 25-46-35 FAX (00 687) 28-66-70 phocidis@phocidis.nc
New Zealand	Fujifilm NZ Ltd Technical support & Repair service	Cnr William Pickering & Bush Road Albany, Auckland TEL +64-9-4140400 FAX +64-9-4140410 glenn.beaumont@fujifilm.co.nz
Papua New Guinea	Oceania PNG Limited Technical support	Section 15, Allotment 1, Reke St, Boroko NCD. PNG. Mail: PO Box 2167, Boroko NCD. PNG. TEL +675 3256411 FAX +675 3250311 oceania@daltron.com.pg
ASIA		
Hong Kong	Fuji Photo Products Co., Ltd. Technical support & Repair service	8/F., TSUEN WAN IND. CENTRE, 220 TEXACO RD., TSUEN WAN, HONG KONG TEL (852)2406 3287 FAX (852)2408 3130 rsd@chinahphoto.com.hk

FUJIFILM Digital Camera Worldwide Network

Indonesia	PT Modern Photo Tbk Technical support & Repair service	Jl.Matraman Raya 12, Jakarta Timur 13150 TEL +62 021 2801000 FAX +62 021 8581620+62 021 2801012 assd_kmr@modernphoto.co.id
Malaysia	FUJIFILM (Malaysia) Sdn. Bhd. Technical support Repair service	Letter Box 1, Level 10, 11 & 12, Menara Axis, No 2, Jalan 51A/223, 46100 Petaling Jaya, Selangor Darul Ehsan, Malaysia TEL 603-79584700 FAX 603-79584110 digital@fujifilm.com.my Letter Box 1, Level 10, 11 & 12, Menara Axis, No 2, Jalan 51A/223, 46100 Petaling Jaya, Selangor Darul Ehsan, Malaysia TEL 603-79584700 FAX 603-79584110 technical@fujifilm.com.my
Philippines	YKL Development & Trdg. Corp. Technical support Repair service	24 Sto. Domingo St., Quezon City 1100, Philippines TEL 632-7436601~06 FAX 632-7324661 digital@yklcolor.com 24 Sto. Domingo St., Quezon City 1100, Philippines TEL 632-7436601~06 FAX 632-7324661 tech_services@yklcolor.com
Singapore	FUJIFILM (Singapore) Pte Ltd Technical support & Repair service	10 New Industrial Road Fujifilm Building Singapore 536201 TEL 65-6380 5557 FAX 65-6281 3594 service@fujifilm.com.sg
South Korea	Korea Fujifilm Co., Ltd. Technical support	30-1, Mukjeung-dong, Jung-gu, Seoul, Korea TEL +82-2-3282-7363 FAX +82-2-2269-7435 photo@fujifilm.co.kr
South Korea	Yonsan AS Center (Fujidigital) Repair service	#301, 3F, Jeonjaland, 16-9, Hangangro3-ga, Yongsan-gu, Seoul, Korea TEL +82-2-701-1472 FAX +82-2-718-1331 1bowl@hanmail.net
South Korea	Kangnam AS Center (Digitalgallery) Repair service	2F, Hyeongin Tower, 23-2, Bangyi-dong, Songpa-gu, Seoul, Korea TEL +82-2-2203-1472 FAX +82-2-418-5572 nurijili@hanmail.net
South Korea	Busan AS Center (Digital-Sewon) Repair service	241-4, Bujeon-dong, Busanjin-gu, Busan, Korea TEL +82-51-806-1472 FAX +82-51-817-0083 merahan@yahoo.co.kr
Taiwan	Hung Chong Corp. Technical support & Repair service	No. 38, Min-Chuan E. Rd. Sec. 6, Taipei (114), Taiwan, R.O.C. TEL 886-2-6602-8988 FAX 886-2-2791-8647 dah@mail.hungchong.com.tw
Thailand	FUJIFILM (Thailand) Ltd. Technical support Repair service	388 SP Building, 8th Floor, Phayathai, Bangkok 10400 TEL +662-2730029 ext. 755 FAX +662-2730239 supaleark@fujifilm.co.th 388 SP Building, 8th Floor, Phayathai, Bangkok 10400 TEL +662-2730029 ext.761,762 FAX +662-2730239 warin@fujifilm.co.th

Safety Notes

- Make sure that you use your IS Pro correctly. Read these Safety Notes and your Owner's Manual carefully before use.
- After reading these Safety Notes, store them in a safe place.

About the Icons

The icons shown below are used in this document to indicate the severity of the injury or damage that can result if the information indicated by the icon is ignored and the product is used incorrectly as a result.



WARNING

This icon indicates that death or serious injury can result if the information is ignored.



CAUTION

This icon indicates that personal injury or material damage can result if the information is ignored.

The icons shown below are used to indicate the nature of the information which is to be observed.



Triangular icons tell you that this information requires attention ("important").



Circular icons with a diagonal bar tell you that the action indicated is prohibited ("Prohibited").



Filled circles with an exclamation mark tell you an action that must be performed ("Required").



WARNING

If a problem arises, turn the camera off, remove the battery, disconnect and unplug the AC power adapter.

Continued use of the camera when it is emitting smoke, is emitting any unusual odor, or is in any other abnormal state can cause a fire or electric shock.

- Contact your FUJIFILM dealer.



Unplug from power socket.

Do not allow water or foreign objects to enter the camera.

If water or foreign objects get inside the camera, turn the camera off, remove the battery and disconnect and unplug the AC power adapter.

Continued use of the camera can cause a fire or electric shock.

- Contact your FUJIFILM dealer.



Do not use the camera in the bathroom or shower.

This can cause a fire or electric shock.



Do not use in the bathroom or shower.







Never attempt to change or take apart the camera. (Never open the casing.) Do not use the camera when it has been dropped or the casing is damaged.





This can cause a fire or electric shock.

- Contact your FUJIFILM dealer.





Do not disassemble.









 WARNING	
<p>Do not change, heat or unduly twist or pull the connection cord and do not place heavy objects on the connection cord.</p> <p>These actions could damage the cord and cause a fire or electric shock.</p> <ul style="list-style-type: none"> • If the cord is damaged, contact your FUJIFILM dealer. 	
<p>Do not place the camera on an unstable surface.</p> <p>This can cause the camera to fall or tip over and cause injury.</p>	
<p>Never attempt to take pictures while in motion.</p> <p>Do not use the camera while you are walking or driving a vehicle. This can result in you falling down or being involved in a traffic accident.</p>	
<p>Do not touch any metal parts of the camera during a thunderstorm.</p> <p>This can cause an electric shock due to induced current from the lightning discharge.</p>	
<p>Do not use the battery except as specified.</p> <p>Load the battery as aligned with the indicator.</p>	

 WARNING	
<p>Do not heat, change or take apart the battery.</p> <p>Do not drop or subject the battery to impacts.</p> <p>Do not store the battery with metallic products.</p> <p>Do not use chargers other than the specified model to charge the battery.</p> <p>Any of these actions can cause the battery to burst or leak and cause fire or injury as a result.</p>	
<p>Use only the battery or AC power adapter specified for use with this camera.</p> <p>Do not use voltages other than the power supply voltage shown.</p> <p>The use of other power sources can cause a fire.</p>	
<p>If the battery leaks and fluid gets in contact with your eyes, skin or clothing. Flush the affected area with clean water and seek medical attention or call an emergency number right away.</p>	
<p>Do not use the charger to charge battery other than those specified here.</p> <p>The charger is designed for the rechargeable battery NP-150. Using the charger to charge conventional batteries or other types of rechargeable battery can cause the battery to leak fluid, overheat or burst.</p>	

Continued ➔

Safety Notes

 WARNING	
<p>When carrying the NP-150, install it in a digital camera or keep it in the soft case provided.</p> <p>When storing the NP-150, keep it in the soft case provided.</p> <p>When discarding, cover the battery terminals with insulation tape.</p> <p>Contact with other metallic objects or battery could cause the battery to ignite or burst.</p>	
<p>Keep memory cards out of the reach of small children.</p> <p>Because memory cards are small, they can be swallowed by children. Be sure to store memory cards out of the reach of small children. If a child swallows a memory card, seek medical attention or call an emergency number.</p>	

 CAUTION	
<p>Do not use this camera in locations affected by oil fumes, steam, humidity or dust.</p> <p>This can cause a fire or electric shock.</p>	
<p>Do not leave this camera in places subject to extremely high temperatures.</p> <p>Do not leave the camera in locations such as a sealed vehicle or in direct sunlight. This can cause a fire.</p>	
<p>Keep out of the reach of small children.</p> <p>This product could cause injury in the hands of a child.</p>	
<p>Do not place heavy objects on the camera.</p> <p>This can cause the heavy object to tip over or fall and cause injury.</p>	
<p>Do not move the camera while the AC power adapter is still connected.</p> <p>Do not pull on the connection cord to disconnect the AC power adapter.</p> <p>This can damage the power cord or cables and cause a fire or electric shock.</p>	
<p>Do not use the AC power adapter when the plug is damaged or the plug socket connection is loose.</p> <p>This could cause a fire or electric shock.</p>	
<p>Do not cover or wrap the camera or the AC power adapter in a cloth or blanket.</p> <p>This can cause heat to build up and distort the casing or cause a fire.</p>	



CAUTION

When you are cleaning the camera or you do not plan to use the camera for an extended period, remove the battery and disconnect and unplug the AC power adapter.

Failure to do so can cause a fire or electric shock.



When charging ends, unplug the charger from the power socket.

Leaving the charger plugged into the power socket can cause a fire.



Using a flash too close to a person's eyes may temporarily affect the eyesight.

Take particular care when photographing infants and young children.



When a memory card is removed, the card could come out of the slot too quickly. Use your finger to hold it and gently release the card.



Request regular internal testing and cleaning for your camera.

Build-up of dust in your camera can cause a fire or electric shock.

- Contact your FUJIFILM dealer to request internal cleaning every 2 years.
- Please note this is not a free of charge service.



FUJIFILM

FUJIFILM Corporation

7-3, AKASAKA 9-CHOME, MINATO-KU, TOKYO 107-0052, JAPAN

<http://www.fujifilm.com/products/digital/>