



**LEICA CL**  
Instruction manual

## FOREWORD

Dear Customer,

We wish you a great deal of fun and success taking photographs with your new Leica CL. Please read this manual thoroughly to familiarize yourself with the full scope of functions your camera has to offer.

Your Leica Camera AG

## SCOPE OF DELIVERY

Before using your camera for the first time, please check that the accessories supplied are complete.

- Leica CL
- Lithium-ion battery Leica BP-DC12
- Charger Leica BC-DC12, incl. mains cable (US, EU)
- Camera bayonet cover
- Accessory shoe cover
- Carry strap
- Quick Start Guide
- CE flyer
- Creative Cloud flyer
- Test certificate

Subject to changes in design and production.

## REPLACEMENT PARTS/ACCESSORIES

Please visit the Leica Camera AG website for information on the extensive range of Leica replacement parts/accessories:

<http://en.leica-camera.com/Photography/Leica-APS-C/Accessories>

Only the accessories specified and described in this manual or by Leica Camera AG must be used with the camera (battery, charger, mains plug, mains cable, etc.). These accessories should only be used with this product. Third-party accessories may result in malfunctions or damage to the product.

Please read the chapters “Legal information”, “Safety remarks”, and “General information” before using your camera for the first time. Knowledge of the content will prevent inadvertent damage to the product, possible injuries and other risks.

## LEGAL INFORMATION

### LEGAL INFORMATION

- Compliance with copyright laws is mandatory. The recording and publication of pre-recorded media, e.g. tapes, CDs, or other published or broadcast material may be in breach of copyright laws.
- The same applies for all software supplied in the scope of delivery.
- The following applies for all video material created with this camera: This product is governed by the AVC Patent Portfolio license and is meant for private use by a consumer only. The device may furthermore be used for purposes for which the consumer receives no remuneration, e.g. (i) encoding in accordance with the AVC Standard (“AVC Video”) and/or (ii) decoding of AVC Video that was encoded by a consumer in accordance with the AVC Standard within the scope of personal use and/or which the consumer has received from the provider, who is in possession of a license to offer AVC Video. No license is granted or implied for any other use. Any other use, specifically the provision of AVC video in exchange for remuneration, may require a separate license agreement with MPEG LA, L.L.C. Please visit the MPEG LA, L.L.C. website at: [www.mpegla.com](http://www.mpegla.com) for more information.

## REGULATORY INFORMATION

You will find the manufacturing date of your camera on the stickers in the Warranty Card and/or on the packaging.  
The date format is year/month/day.

Specific regional approvals for this device can be found in the camera menu.

- ▶ Select **Camera Information** in the main menu
- ▶ Select **Regulatory Information** from the submenu

The CE mark on our products documents compliance with the fundamental requirements of applicable EU guidelines.

#### Deutsch

##### Konformitätserklärung (DoC)

Die "Leica Camera AG" bestätigt hiermit, dass dieses Produkt den grundlegenden Anforderungen und sonstigen relevanten Vorgaben der Richtlinie 2014/53/EU entspricht.

Kunden können eine Kopie der Original-DoC zu unseren RE-Produkten von unserem DoC-Server herunterladen:  
[www.cert.leica-camera.com](http://www.cert.leica-camera.com)

Wenden Sie sich im Fall weiterer Fragen an den Produkt Support der Leica Camera AG: Am Leitz-Park 5, 35578 Wetzlar, Deutschland

##### Produktabhängig (siehe Technische Daten)

Type	Frequency band (central frequency)	Maximum power (dBm e.i.r.p.)
WLAN	2412 - 2462 MHz/	20
	5180 - 5240 MHz/	20
	5260 - 5320 MHz/ 5500 - 5700 MHz	20
Bluetooth	2402 - 2480 MHz	20



## DISPOSAL OF ELECTRICAL AND ELECTRONIC EQUIPMENT

(Applies within the EU and for other European countries with active waste separation policies.)

This device contains electric and/or electronic components which must not be disposed of in general household waste. Instead, it should be disposed of at a recycling collection point provided by your local authority.

This service is free of charge. Any standard or rechargeable batteries used in this device must be removed and disposed of separately in accordance with local regulations.

Please contact your local authorities, waste disposal collection point or the retailer, from whom you purchased the device for more information on correct waste disposal.

## IMPORTANT NOTES REGARDING THE USE OF WLAN/BLUETOOTH® (LEICA FOTOS)

Please read the important notes on specific functions of Leica FOTOS on p. 132.

- Appropriate measures must be taken to ensure security and protect against disruptions to the systems in place where devices or computer systems are in use that require more stringent security than WLAN devices.
- Leica Camera AG shall not accept liability for damages arising from the use of the camera for purposes other than as a WLAN device.
- It is assumed that the WLAN function will be used in countries where this camera is sold. There may be a risk of breaching statutory wireless communication regulations when using the camera in other countries. Leica Camera AG shall not accept liability for such breaches.
- Please note that there is a risk of unauthorized third party interception of wirelessly communicated data. We highly recommend that you activate encryption in the wireless access point settings to ensure data safety.
- Avoid using the camera in areas where it can be exposed to magnetic fields, static electricity or other interferences, e.g. near a microwave oven. RF transmissions may otherwise not reach the camera.
- Using the camera near devices like microwave ovens or wireless phones that use the 2.4 GHz RF band may negatively affect the performance of both devices.
- Do not attempt to connect to wireless networks you are not authorized to use.
- The device will automatically search for wireless networks, once the WLAN function is enabled. A list, including networks you are not authorized to access, will be displayed (SSID: Network

identifier for a WLAN network). Do not attempt to connect to such a network, as this could be construed as unauthorized access.

- We recommend disabling the WLAN function while on an aircraft.



## SAFETY REMARKS

### GENERAL INFORMATION

- Do not use your camera in the immediate vicinity of devices that generate powerful magnetic, electrostatic or electromagnetic fields (e.g. induction ovens, microwave ovens, television sets or computer screens, video game consoles, cell phones, broadcasting equipment). Their electromagnetic fields can interfere with recordings.
- Strong magnetic fields, e.g. from speakers or large electric motors can damage the stored picture data or disrupt recording.
- Switch off the camera, remove the battery briefly, replace it and switch the camera back on in case of a camera malfunction due to the effects of electromagnetic fields.
- Do not use the camera in the immediate vicinity of radio transmitters or high-voltage power lines. Their electromagnetic fields may interfere with recordings.
- Always store small parts e.g. the accessory shoe cover as follows:
  - out of the reach of children
  - in a safe location, where they will not get lost or stolen
- State-of-the-art electronic components are sensitive to static discharge. You can easily pick up charges of several 10,000 volts by simply walking on synthetic floor coverings. A static discharge can occur when you touch the camera and especially if it is placed on a conductive surface. A static discharge on the camera housing poses no risk for the electronics. Despite built-in safety circuits, you should avoid direct contact with external camera contacts like those in the flash shoe.
- Take care not to soil or scratch the sensor for lens detection in the bayonet. You must similarly prevent direct contact of the bayonet with grains of sand or similar particles, as these could cause irreparable damage. This component must only be cleaned with a dry cloth (in system cameras).
- Use a cotton or linen cloth instead of a microfiber cloth from an optician's (synthetic) when cleaning the contacts. Make sure to discharge any electrostatic charge by deliberately touching a heating or water pipe (conductive, grounded material). Dirt deposits and oxidation on the contacts can be avoided by storing your camera in a dry location with the lens cap and the flash shoe/viewfinder cap (in system cameras) attached.
- Only use accessories specified for this model to prevent faults, short circuits or electric shock.
- Do not attempt to remove parts of the housing (covers) yourself. Repairs must be done at authorized service centers only.
- Protect the camera against contact with insect sprays and other aggressive chemicals. Petroleum spirit, thinner and alcohol must not be used for cleaning. Some chemicals and liquids can damage the camera housing or the surface finish.
- Rubber and plastics are known to expel aggressive chemicals and should therefore not be kept in contact with the camera for extended periods of time.
- Prevent any sand or dust or water penetration into the camera, e.g. during snowfall or rain or on the beach. Be extra careful when changing the lens (in system cameras) and when inserting or removing the memory card and rechargeable battery. Sand and dust can damage the camera, the lens, the memory card and the battery. Moisture can cause malfunctions and irreparable damage to the camera and memory card.



## LENS

- A camera lens can have the effect of a magnifying glass when exposed to direct frontal sunlight. The camera must therefore be protected against extended exposure to direct sunlight.
- Attaching the lens cap and keeping the camera in the shade or ideally in its camera case, will help prevent damage to the interior of the camera.

## RECHARGEABLE BATTERY

- Improper use of the batteries or the use of unapproved battery types may result in an explosion!
- Do not expose the rechargeable battery to sunlight, heat, humidity or moisture for prolonged periods of time. Likewise, the batteries must not be placed in a microwave oven or a high-pressure container as this would pose a fire or explosion hazard.
- Do not under any circumstances charge or insert a damp or wet battery into the camera!
- A safety valve in the battery ensures that any excess pressure caused by improper handling is discharged safely. It is nevertheless important to dispose of a bloated battery immediately. It may pose an explosion hazard!
- Keep the battery contacts clean and easily accessible. Although lithium-ion batteries are secured against short circuits, they should still be protected against contact with metal objects like paper clips or jewelry. A short-circuited battery can get very hot and cause severe burns.
- When a battery is accidentally dropped, make sure to check the housing and the contacts immediately for any damage. A damaged battery can damage the camera.
- The battery must be removed from the camera or charger and must be replaced immediately in case of a strange smell,

discoloration, deformation, overheating or leakage. Continued use of the battery may result in overheating, which can cause fire and/or explosion!

- Never throw batteries into a fire as they may explode.
- Keep the battery away from sources of heat in case of leakage or if you smell burning. Leaked fluid can catch fire!
- The use of other chargers not approved by Leica Camera AG can cause damage to the batteries – and in extreme cases – cause serious or life-threatening injuries.
- Make sure that the power socket is freely accessible at all times.
- The in-car charging cable supplied must never be connected while the charger is connected to mains electricity.
- Do not attempt to open the battery or the charger. Repairs must only be carried out by authorized service centers.
- Keep batteries out of the reach of children. Batteries can cause suffocation when swallowed.

### FIRST AID

- Battery fluid may cause blindness if it comes into contact with the eyes. Rinse the eyes thoroughly with clean water immediately. Avoid rubbing. Seek medical attention immediately.
- Leaked battery fluid poses an injury hazard when it comes in contact with clothing or skin. Rinse the affected areas thoroughly with clean water.

## CHARGER

- Using the charger in the vicinity of broadcasting receivers may interfere with reception. Ensure a distance of at least 1 m (3 ft) between the charger and the receiver.
- When the charger is in use, it may emit a buzzing sound – this is normal and not a malfunction.
- Disconnect the charger from the mains when it is not in use, as it consumes electricity (a very small amount), even if no battery is inserted.
- Always keep the charger contacts clean, and never short circuit them.

## MEMORY CARD

- Never remove the memory card during a datasave or card reading process. The camera must not be switched off or be subjected to impact or vibrations while working.
- Do not open the cover/remove the memory card or the battery while the status LED is lit, which indicates memory access. Data on the card may otherwise be destroyed and camera malfunctions may occur.
- Do not drop or bend memory cards as this will cause damage and result in the loss of stored data.
- Do not touch the connections on the reverse of the memory card and keep them clean and dry.
- Keep memory cards out of the reach of children. Swallowing a memory card may cause suffocation.

## SENSOR

Cosmic radiation (e.g. during flights) may cause pixel defects.

## CARRY STRAP

- Carry straps are usually made of very robust material. You should therefore keep it out of the reach of children. A carry strap is not a toy and poses a strangulation risk.
- Use the carry strap only for its intended purpose on a camera or on binoculars. Any other use poses the risk of injury and may possibly result in damage to the carry strap and is therefore not permitted.
- Carry straps should also not be used for cameras/binoculars during sports activities that pose a risk of entanglement (e.g. when mountain climbing and similar outdoor activities).

Please read the section about “Care/Maintenance” for more information about what to do in case of problems.

## GENERAL INFORMATION

### CAMERA/LENS

- Make a note of the serial numbers of your camera (engraved in the base of the camera housing) and lenses, as this information will be extremely important in case of loss.
- Make sure to always have a lens or the camera bayonet cover attached to prevent dust or other foreign bodies penetrating the camera.
- That is why you should always replace lenses quickly and in a dust-free environment.
- Never store the camera bayonet cover or the lens back cover in a pants pocket, as they will attract lint and dust, which could then be accidentally introduced into the camera.
- Leica releases firmware updates for lenses at irregular intervals. You can download any new firmware version from our homepage and transfer it to your lens. Please read the section “Installing firmware” (p. 128) for more information.

### LCD PANEL

- Condensation may form on the LCD panel if the camera is exposed to great temperature fluctuations. Wipe the screen carefully with a soft, dry cloth.
- The screen image will initially be slightly darker than normal if the camera is very cold when it is switched on. The normal level of brightness will be reached as soon as the LCD panel warms up.

## RECHARGEABLE BATTERY

- The battery must have a temperature between + 0°C and + 35°C for charging (otherwise the charger will not switch on or will switch off again immediately).
- Lithium-ion batteries can be charged at any time, regardless of their current charge level. A partially charged battery will charge to full capacity faster than a fully discharged one.
- The rechargeable batteries come only partly charged ex works and should therefore be charged fully before their first use.
- A new battery only reaches its full capacity after it has been fully charged and – by using it in the camera – depleted 2 to 3 times. This depletion process should be repeated roughly every 25 cycles.
- Battery and charger heat up during the charging process. That is normal and not a malfunction.
- Rapid flashing of the two LEDs (> 2 Hz) when charging commences indicates a charging error (e.g. maximum charging time exceeded, voltages or temperatures outside permitted ranges or a short circuit). Disconnect the charger from the mains and remove the battery. Ensure that the above temperature conditions are met and then restart the charging process. Please contact your dealer, the Leica office in your country or Leica Camera AG if the problem persists.
- Rechargeable lithium-ion batteries generate power by way of internal chemical reactions. These reactions are influenced by ambient temperature and humidity. To ensure a maximum service life of the battery, it should not be exposed to extreme temperatures (high or low) for extended periods of time (e.g. in a parked car in the summer or winter).
- However, every battery has a limited service life! After several hundred charging cycles, this limitation will become evident as the operating times get significantly shorter.

- The replaceable battery supplies power to a backup battery, which is permanently installed in the camera. This backup battery retains the date and time for some weeks. Once the backup battery is depleted, it must be replenished by inserting a charged main battery. The time and date will have to be set again after a full depletion of both batteries.
- As the battery capacity deteriorates or if using an older battery, warning messages may appear and some functions may be restricted or blocked entirely.
- Remove the battery if the camera will not be used for an extended period of time. Make sure to switch the camera off via the main switch before removing the battery. Leaving the battery in the camera will result in a deep discharge after a few weeks. Voltage levels will decrease significantly, as the camera uses a low idle current to maintain settings.
- Dispose of damaged batteries in accordance with the relevant regulations at an approved collection point for proper recycling.
- The date of manufacture can be found on the battery. The date format is week/year.

## MEMORY CARD

- The range of available SD/SDHC/SDXC cards on the market is too extensive for Leica Camera AG to test for compatibility and quality. Generally, any type of memory card may be used without any damage to the camera or memory card. As some "no name" cards may not fully comply with the SD/SDHC/SDXC standards, Leica Camera AG cannot provide any guarantee of function.
- We recommend formatting memory cards from time to time, because fragmented residual data from deleted files may block some of the storage capacity.
- Generally, it is not necessary to format (initialize) memory cards that have been previously used. Formatting will, however, be necessary if you insert an unformatted memory card or a card that was formatted in another device (e.g. a computer) for the first time.
- We recommend backing up your data on a PC, because electromagnetic fields, static electricity and any memory card or camera defects could result in permanent damage or loss of your data.
- SD, SDHC, and SDXC memory cards come with a write protection slider to prevent accidental overwriting. This slider is located on the non-beveled side of the card. All data on the card is protected when the slider is set to its lower position, marked LOCK.

## SENSOR

- Any dust or dirt particles stuck to the glass cover of the sensor may result in noticeable dark stains or specks on the pictures.

## DATA

- All data, including personal information, may be changed or deleted due to incorrect or accidental operation, static discharge, accidents, malfunctions, repairs and other measures.
- Please note that Leica Camera AG does not accept liability for direct or consequential damage due to the manipulation or destruction of data and personal information.

## FIRMWARE UPDATE

Leica is constantly working on developing and optimizing the Leica CL. As many functions on digital cameras are controlled purely electronically, improvements and extensions to the range of functions may need to be installed on the camera at a later date. Leica releases what are known as firmware updates at irregular intervals. Cameras are always supplied from the factory with the latest firmware. Otherwise you can download it from our website yourself and transfer it to your camera.

You will receive a newsletter informing you of the availability of a new firmware update if you register your camera on the Leica Camera homepage.

Visit the download section or the "Customer Area" for information about how to register or how to get firmware updates for your Leica CL. Additionally, you can find information about changes or additions to the manual at:

<https://owners.leica-camera.com>

Select menu item "Firmware" (see p. 127) to check whether your camera and lenses are running the latest firmware version.

## WARRANTY

In addition to your statutory warranty rights regarding your dealer, you will receive an additional Leica Camera AG product warranty valid from the date of purchase at an authorized Leica retailer. For more information regarding the warranty scope, services and limitations, please visit: [warranty.leica-camera.com](http://warranty.leica-camera.com)

# TABLE OF CONTENT

FOREWORD .....	2	Right setting wheel.....	38
SCOPE OF DELIVERY .....	2	RIGHT SETTING WHEEL BUTTON .....	38
REPLACEMENT PARTS/ACCESSORIES .....	3	DIRECTIONAL PAD/CENTER BUTTON.....	39
LEGAL INFORMATION .....	4	PLAY BUTTON/FN BUTTON/MENU BUTTON .....	40
SAFETY REMARKS .....	8	TOUCH SCREEN .....	40
GENERAL INFORMATION .....	12	TOP DISPLAY.....	41
WARRANTY.....	15	<b>MENU CONTROL.....</b>	<b>42</b>
TABLE OF CONTENT .....	16	CONTROL ELEMENTS .....	42
PART DESIGNATIONS .....	20	STRUCTURE OF THE MENU SCREEN .....	43
DISPLAYS.....	22	MENU NAVIGATION .....	44
PHOTO .....	22	FAVORITES MENU .....	49
VIDEO .....	24	DIRECT ACCESS TO MENU FUNCTIONS .....	50
DISPLAYS IN THE TOP DISPLAY .....	25	<b>KEYLOCK.....</b>	<b>51</b>
PREPARATION .....	26	<b>CAMERA DEFAULT SETTINGS .....</b>	<b>52</b>
ATTACHING THE CARRY STRAP .....	26	MENU LANGUAGE .....	52
PREPARING THE CHARGER.....	26	DATE/TIME.....	52
CHARGING THE BATTERY.....	27	POWER SAVE MODE (STANDBY MODE).....	53
INSERTING/REMOVING THE BATTERY.....	28	LCD PANEL/VIEWFINDER (EVF) SETTINGS .....	54
INSERTING/REMOVING THE MEMORY CARD.....	30	LCD PANEL/EVF USE.....	54
DIOPTER SETTINGS .....	32	EYE SENSOR SENSITIVITY.....	55
CHANGING THE LENS .....	33	BRIGHTNESS.....	55
COMPATIBLE LENSES .....	34	INFORMATION DISPLAYS .....	56
CAMERA OPERATION.....	36	AUTOMATIC DEACTIVATION OF ALL DISPLAYS .....	56
OPERATING ELEMENTS.....	36	<b>ACOUSTIC SIGNALS .....</b>	<b>57</b>
MAIN SWITCH .....	36	ELECTRONIC SHUTTER SOUND .....	57
SHUTTER BUTTON .....	37	AUTOFOCUS CONFIRMATION .....	57
LEFT SETTING WHEEL.....	38	<b>BASIC PICTURE SETTINGS .....</b>	<b>58</b>
Left setting wheel button.....	38	<b>PHOTO .....</b>	<b>58</b>
		FILE FORMAT.....	58
		JPG RESOLUTION .....	58
		IMAGE PROPERTIES.....	59



COLOR PROFILE.....	60	COMPATIBLE FLASH UNITS.....	95
MONOCHROME PROFILE.....	60	FLASH EXPOSURE METERING (TTL METERING).....	96
IMAGE STABILIZATION.....	61	FLASH MODES.....	97
<b>VIDEO.....</b>	<b>62</b>	FLASH CONTROL.....	98
FILE FORMAT.....	62	<b>VIDEO MODE.....</b>	<b>102</b>
VIDEO RESOLUTION.....	62	<b>START/EXIT VIDEO MODE.....</b>	<b>102</b>
MICROPHONE.....	62	<b>START/END VIDEO RECORDING.....</b>	<b>103</b>
VIDEO STABILIZATION.....	63	EXPOSURE CONTROL.....	103
IMAGE PROPERTIES.....	63	FOCUSING.....	103
<b>PICTURE MODE.....</b>	<b>64</b>	<b>PLAYBACK/REVIEW MODE.....</b>	<b>104</b>
<b>FOCUSING.....</b>	<b>64</b>	<b>INITIATE/EXIT PLAYBACK/REVIEW MODE.....</b>	<b>104</b>
AUTOFOCUS MODES.....	64	<b>SELECTING/SCROLLING THROUGH RECORDINGS.....</b>	<b>105</b>
AUTOFOCUS METERING METHODS.....	65	<b>DISPLAYS IN PLAYBACK/REVIEW MODE.....</b>	<b>105</b>
LIMITING THE AUTOFOCUS SETTING RANGE.....	67	DISPLAYING ASSIST FUNCTIONS.....	107
MF ASSIST FUNCTIONS.....	68	<b>CROPPED SECTION ZOOM.....</b>	<b>107</b>
MANUAL FOCUSING (MF).....	69	<b>DISPLAYING MULTIPLE RECORDINGS AT ONCE.....</b>	<b>109</b>
MF ASSIST FUNCTIONS.....	69	<b>TAGGING/RATING OF RECORDINGS.....</b>	<b>110</b>
<b>ISO SENSITIVITY.....</b>	<b>71</b>	<b>DELETING RECORDINGS.....</b>	<b>111</b>
<b>WHITE BALANCE.....</b>	<b>72</b>	DELETING INDIVIDUAL RECORDINGS.....	111
<b>EXPOSURE.....</b>	<b>74</b>	DELETING MULTIPLE RECORDINGS.....	112
EXPOSURE METERING METHODS.....	74	DELETING ALL RECORDINGS.....	113
FULLY AUTOMATIC EXPOSURE SETTING - P.....	76	DELETING UNRATED RECORDINGS.....	114
SCENE MODE.....	77	<b>PREVIEW OF LATEST RECORDING.....</b>	<b>114</b>
Exposure simulation is active in all modes (see p. 83).....	78	<b>SLIDE SHOW.....</b>	<b>115</b>
SEMI-AUTOMATIC EXPOSURE SETTING - A/S.....	81	<b>VIDEO PLAYBACK.....</b>	<b>116</b>
MANUAL EXPOSURE SETTING - M.....	83	VIDEO EDITING.....	120
EXPOSURE CONTROL.....	83		
<b>OTHER FUNCTIONS.....</b>	<b>88</b>		
AUXILIARY DISPLAYS.....	88		
SERIAL EXPOSURES.....	91		
INTERVAL SHOOTING.....	92		
SELF-TIMER.....	94		
<b>FLASH PHOTOGRAPHY.....</b>	<b>95</b>		

<b>OTHER FUNCTIONS .....</b>	<b>122</b>
<b>USER PROFILES .....</b>	<b>122</b>
<b>DATA MANAGEMENT .....</b>	<b>124</b>
DATA STRUCTURE ON THE MEMORY CARD.....	124
EDIT FILE NAMES.....	125
CREATING A NEW FOLDER .....	125
FORMATTING A MEMORY CARD.....	126
<b>DATA TRANSFER .....</b>	<b>127</b>
<b>USING RAW DATA (DNG).....</b>	<b>127</b>
<b>RESETTING THE CAMERA     TO FACTORY SETTINGS.....</b>	<b>127</b>
<b>FIRMWARE UPDATES .....</b>	<b>127</b>
<b>LEICA FOTOS .....</b>	<b>130</b>
<b>CONNECTION.....</b>	<b>130</b>
<b>REMOTE CAMERA CONTROL .....</b>	<b>132</b>
<b>CARE/STORAGE.....</b>	<b>134</b>
<b>FAQ.....</b>	<b>135</b>
<b>INDEX.....</b>	<b>141</b>
<b>MENU OVERVIEW .....</b>	<b>144</b>
<b>TECHNICAL DATA.....</b>	<b>145</b>
<b>LEICA CUSTOMER CARE.....</b>	<b>150</b>

**Definition of the various categories of information found in this manual****Note**

Additional information

**Important**

Failure to observe the instructions may result in damage to the camera, the accessories or the pictures.

**Attention**

Non-compliance may result in personal injury

## PART DESIGNATIONS

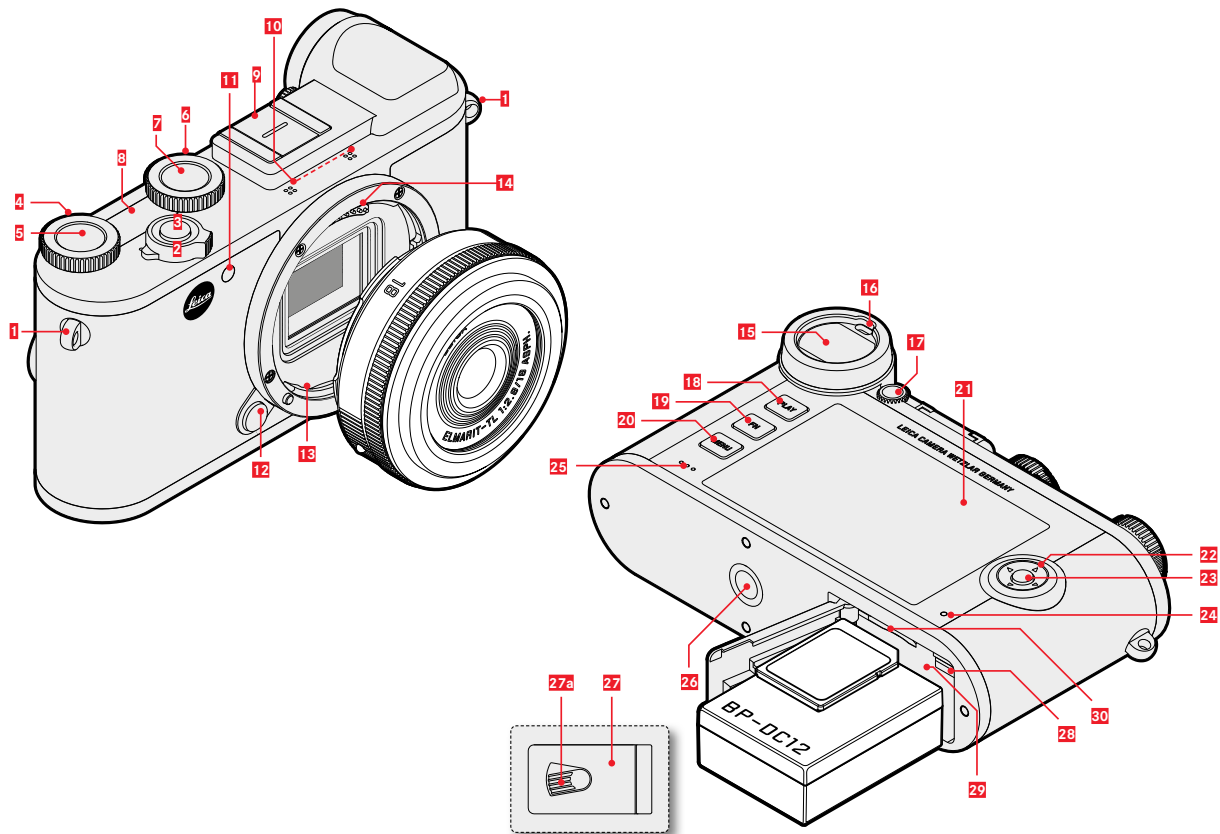

- 1** Strap lugs
- 2** Main switch
- 3** Shutter button
- 4** Right setting wheel
- 5** Right setting wheel button
- 6** Left setting wheel
- 7** Left setting wheel button
- 8** Top display
- 9** Accessory shoe
- 10** Microphone
- 11** Self-timer LED/AF assist light
- 12** Lens release button
- 13** Bayonet
- 14** contact strip
- 15** Viewfinder eyepiece
- 16** Eye sensor
- 17** Diopter setting wheel
- 18** **PLAY** button
- 19** **FN** button
- 20** **MENU** button

- 21** LCD panel
- 22** Directional pad
- 23** Center button
- 24** Status LED
- 25** Speaker
- 26** Tripod thread
- 27** Cover for battery compartment and memory card slot
- 27a** Release lever
- 28** Battery release lever
- 29** Battery compartment
- 30** Memory card slot

\*Lens not included in the delivery package.

## DISPLAYS

The images displayed on the LCD panel and in the viewfinder are identical.

## PHOTO

### WHEN TAKING A PICTURE

All displays/values refer to the actual settings

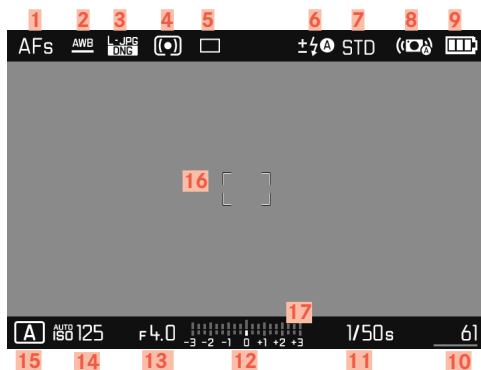

### IN REVIEW MODE

All displays/values refer to the displayed image

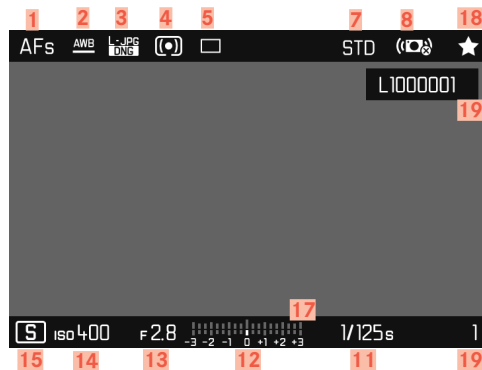

- 1 Focus mode
- 2 White balance mode
- 3 File format/compression level/resolution
- 4 Exposure metering method
- 5 Picture mode (Picture sequence)
- 6 Flash mode/flash exposure compensation
- 7 Color rendering (Film Style)
- 8 Stabilization activated
- 9 Battery capacity
- 10 Remaining number of exposures incl. trend detection via bar chart = remaining capacity of the inserted memory card
- 11 Shutter speed
- 12 Light balance
- 13 Exposure value
- 14 ISO Sensitivity
- 15 Exposure mode
- 16 AF Field
- 17 Exposure compensation scale
- 18 Icon for marked picture
- 19 File number of the picture shown

#### Activated Capture Assistants

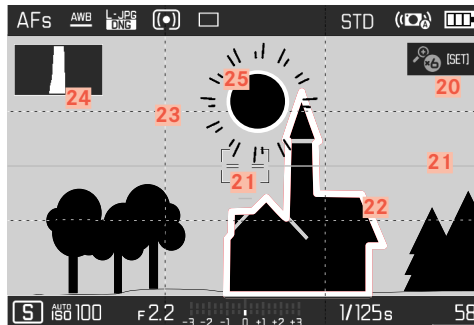

- 20 Automatic magnification as Focus Assist for manual focusing (+3x or +6x magnification available)
- 21 Level display (Horizon)
- 22 Focus Peaking (identification of in sharp edges in the object)
- 23 Grid lines
- 24 Histogram
- 25 Clipping identification of overexposed subject elements

## VIDEO

### WHEN TAKING A PICTURE

All displays/values refer to the actual settings

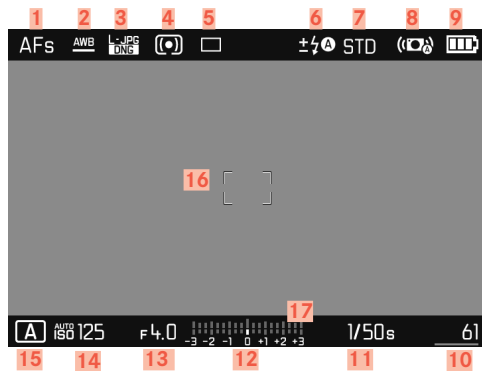

### IN PLAYBACK MODE

All displays/values refer to the displayed image

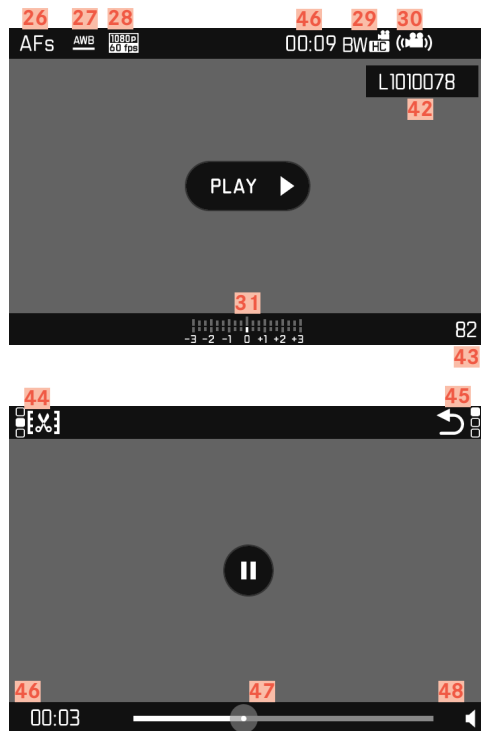



- 26 Focus mode
- 27 White balance mode
- 28 Video Resolution
- 29 Color rendering (Video Style)
- 30 Stabilization activated
- 31 Light balance
- 32 Exposure compensation scale
- 33 Microphone recording level
- 34 Battery capacity
- 35 Histogram
- 36 Video mode
- 37 ISO Sensitivity
- 38 Exposure value
- 39 Shutter speed
- 40 Total remaining memory capacity/recording time
- 41 Length of recording
- 42 File name
- 43 Number of pictures on the memory card
- 44 Video editing function
- 45 Exiting video playback
- 46 Elapsed playback time
- 47 Playback status bar
- 48 Playback volume

## DISPLAYS IN THE TOP DISPLAY

When the camera is switched on



49 Camera name

50 Battery status

Standard view



51 Aperture

52 Exposure mode

53 Shutter speed

When changing modes



54 Currently selected exposure mode

55 Arrows for the shift direction

## PREPARATION

### ATTACHING THE CARRY STRAP

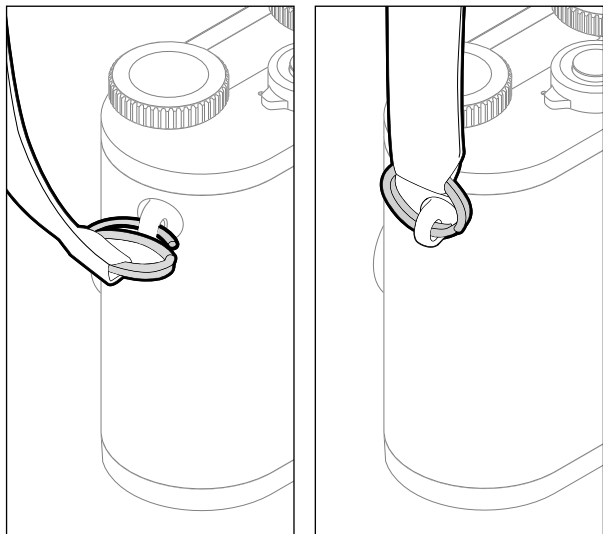

#### Attention

Once you have attached the carry strap, please make sure that the clips are mounted correctly to prevent the camera from falling.

### PREPARING THE CHARGER

Use the mains cable with the matching regional plug to connect the charger to mains electricity.

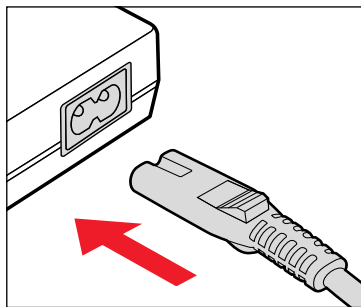

#### Note

The charger will automatically adapt to local mains voltage.

## CHARGING THE BATTERY

The camera is powered by a lithium-ion battery.

### INSERTING THE BATTERY IN THE CHARGER

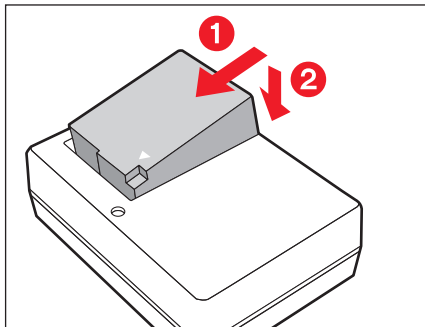

- ▶ Insert the battery into the charger at an angle so that the contacts meet
- ▶ Press down on the battery until you can hear and feel it clicking into place

### REMOVING THE BATTERY FROM THE CHARGER

- ▶ Tilt the battery up and lift it out at an angle

## CHARGE STATUS INDICATORS ON THE CHARGER

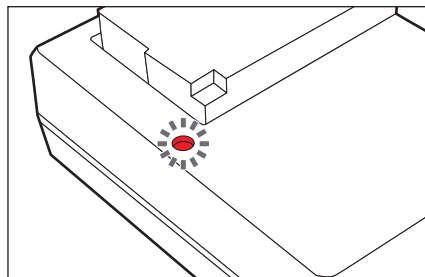

The status LED indicates a correct charging process.

Display	Charge status
lights up green	battery is charging
goes out	100%

Disconnect the charger from mains electricity when the charging process is complete. There is no risk of overcharging.

## INSERTING/REMOVING THE BATTERY

- ▶ Ensure that the camera is switched OFF (see p. 36)
- ▶ Open the cover of the battery compartment/memory card slot and close it again afterwardsn (see p. 31)

### Important

Removing the battery while the camera is switched on may result in the loss of custom settings or damage to the memory card.

## INSERTION

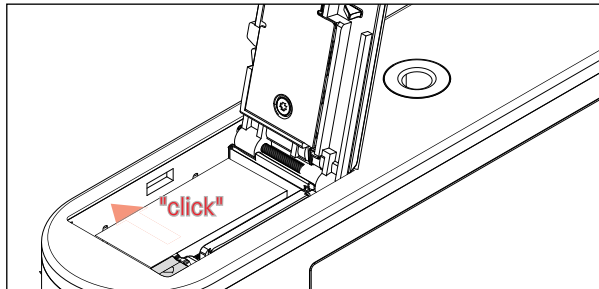
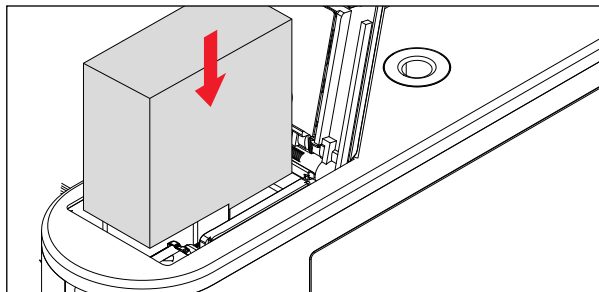

- ▶ Insert the battery into the charger so that the contacts meet
- ▶ Press the battery down into the battery compartment
  - The battery locking latch will spring out to secure the battery.

## REMOVAL

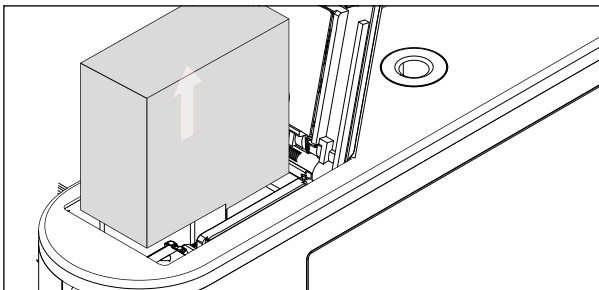
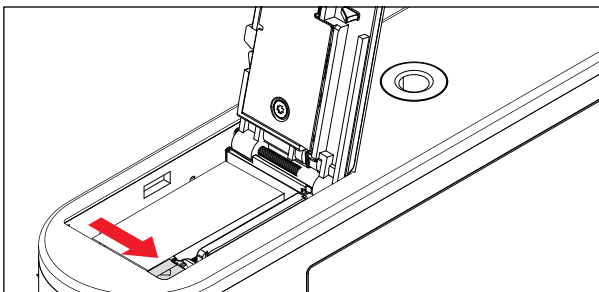

- ▶ Press the battery locking latch as shown
  - The battery will spring out a little.
- ▶ Removing the battery

## CHARGE STATUS INDICATOR ON THE LCD PANEL

The battery charge status is displayed on the LCD panel (see p. 23).

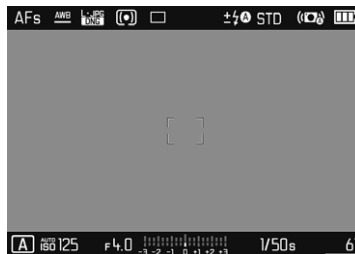

## INSERTING/REMOVING THE MEMORY CARD

The camera will save exposures to an SD (Secure Digital), SDHC (High Capacity) or SDXC (eXtended Capacity) memory card.

### Notes

- SD/SDHC/SDXC memory cards are available from various suppliers in various sizes and with differing read/write speeds. Memory cards with high storage capacities and high read/write speeds offer quick storage and rendering.
- Check the memory card for correct alignment if you are having difficulties inserting it into the camera.
- Video recordings require a high write speed.
- Proper camera function cannot be guaranteed when using WLAN memory cards.

- ▶ Ensure that the camera is switched OFF (see p. 36)
- ▶ Open the cover of the battery compartment/memory card slot and close it again afterwards (see p. 31)

### INSERTION

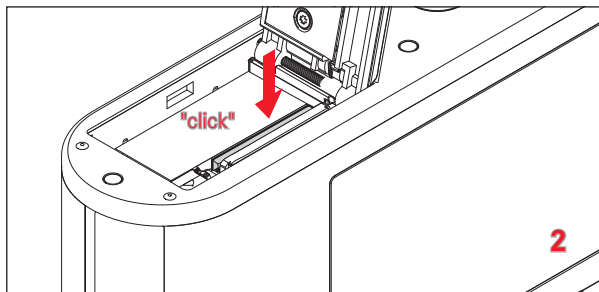
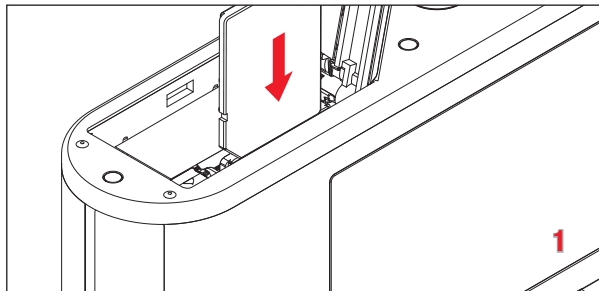

- ▶ Push the memory card into the slot until you hear and feel it clicking into place

## REMOVAL

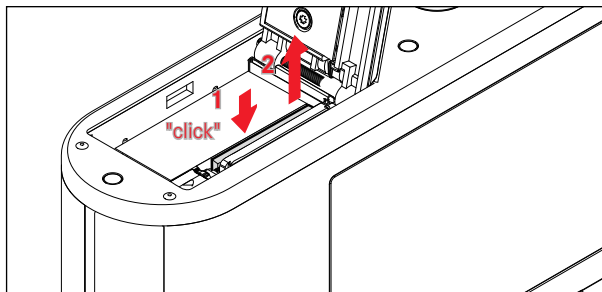

- ▶ Push down on the card until you hear a click
  - The card pushes out slightly.
- ▶ Remove the memory card

## OPENING/CLOSING THE COVER OVER THE BATTERY COMPARTMENT/MEMORY CARD SLOT

### OPEN

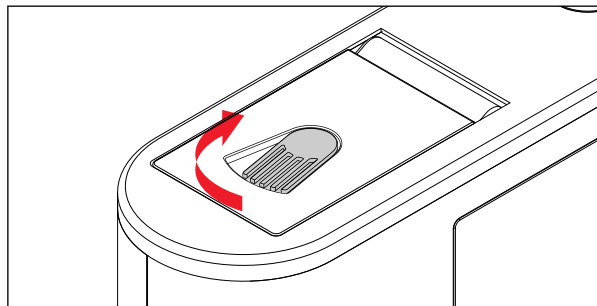

- ▶ Push the release lever in the direction of the arrow
  - The cover opens.

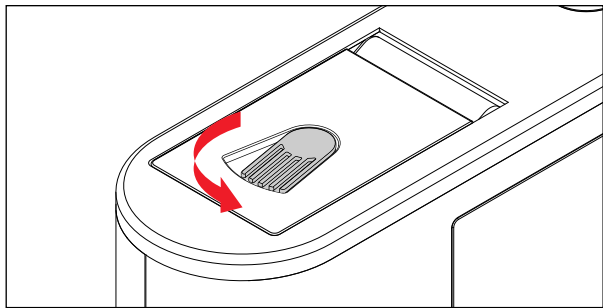
**CLOSE**

- ▶ Close and hold the cover.
- ▶ Push the release lever in the direction of the arrow.

**DIOPTER SETTINGS**

The viewfinder has a diopter setting function with a range between +4 and -4 diopter to allow glasses wearers the use of the camera without eyeglasses (Diopter adjustment).

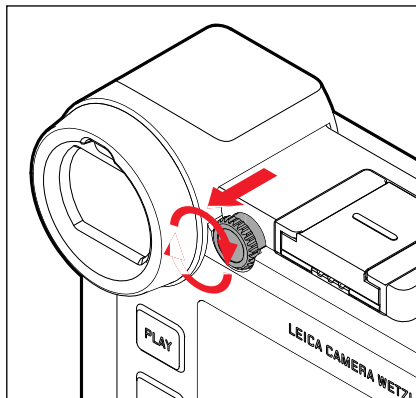

- ▶ Pull the setting wheel on the right of the eyepiece backward to unlock
- ▶ Look through the viewfinder
- ▶ Turn the diopter setting wheel until you see the image in the viewfinder and the displays in perfect focus
- ▶ Push the setting wheel back into the locked position



## CHANGING THE LENS

### ATTACHING THE LENS

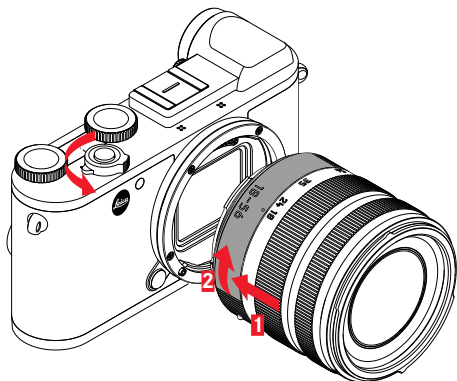

- ▶ Ensure that the camera is switched OFF
- ▶ Hold the lens on the fixed ring
- ▶ Position the alignment button on the lens opposite the release button on the camera housing
- ▶ Attach the lens in this position
- ▶ Turn the lens clockwise until you hear and feel it click into place

### DETACHING THE LENS

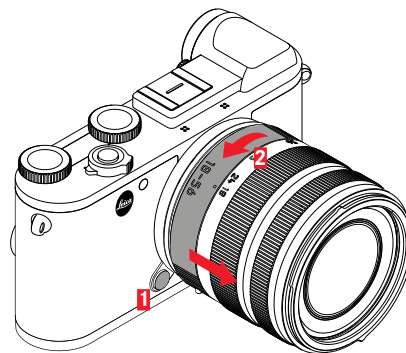

- ▶ Ensure that the camera is switched OFF
- ▶ Hold the lens on the fixed ring
- ▶ Press and hold the release button on the camera housing
- ▶ Turn the lens counter-clockwise until the alignment button is opposite the release button
- ▶ Remove the lens

## COMPATIBLE LENSES

All Leica TL lenses share the same basic external structure: They have an external bayonet fitting for the lens hood, an internal thread for filters, a focus setting ring, a fixed ring with a red alignment button for lens changes, and a contact strip for the transfer of data and control signals. Leica CL Vario lenses have an additional zoom setting ring with its own alignment point. In addition to Leica TL lenses, the Leica CL can also accommodate Leica SL lenses with full functionality via the L bayonet. Leica M and R lenses can also be used in conjunction with Leica M/R L adapters.

## EXPOSURE METERING AND EXPOSURE CONTROL USING VARIO LENSES

Some Leica TL and SL zoom lenses have a variable speed, i.e. the effective aperture opening depends on the configured focal length. Make sure to set the desired focal length before storing the meter value or changing the shutter speed/aperture combination to prevent incorrect exposure. Please read the sections on "Exposure" starting on page 74 for more information. Make sure that the aperture setting on the flash unit matches the camera aperture if you are using a non-system compatible flash unit.

## LENS HOODS

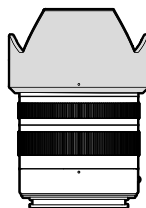

Picture position

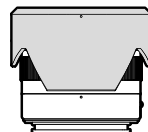

Transport position

Leica CL lenses are usually supplied with matching lens hoods. The symmetrical bayonet fitting can be attached quickly and easily in operational position, as well as in reverse position for space-saving storage.

Lens hoods reduce light scatter and reflection, and protect the front lens against damage and soiling.

## FILTERS

Leica CL lenses can accommodate screw-on filters. Please read the technical information provided in the lens manual for the correct diameter.

## USING LEICA M AND R LENSES

Leica M and R lenses can be attached via Leica M or R L adapters. There are lens profiles stored in the camera, which allow the following functions:

- The flash exposure and flash reflector controls utilize the stored lens data (see “Compatible flash units”).
- The lens data is furthermore written to the EXIF data of the images. The focal length of the lens is additionally displayed when rendering the extended picture data.

The camera will automatically select the appropriate lens type settings if the Leica M lens used comes with 6 bit encoding, or the Leica R lens has an ROM contact strip. You will have to enter the lens model manually if the lenses are not relevantly equipped.

- ▶ Select **Lens Profiles** in the main menu
- ▶ Select automatic lens identification (**Auto**) in the submenu, or enter the lens model manually into one of the two lens lists, or deactivate the function altogether.

If you want to enter the lens model yourself:

- ▶ Select **M Lenses** or **R Lenses**

You can shorten the lens lists by deleting all unnecessary lens types to simplify operation:

- ▶ Select **Edit list of M lenses** or **Edit list of R lenses** in the **M lenses** or **R lenses** submenus.
- ▶ Activate (**On**) or deactivate (**Off**) the lens types you will be using in the lens lists

### Note

This menu item is not available for Leica TL and SL lenses and the relevant item line is marked unavailable in gray lettering.

## CAMERA OPERATION

### OPERATING ELEMENTS

#### MAIN SWITCH

The main switch switches the camera on and off.

#### SWITCHING THE CAMERA ON

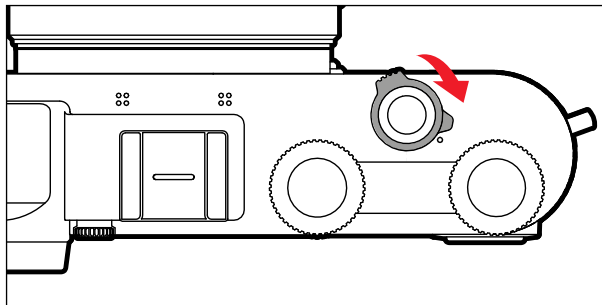

#### Notes

- Once switched on, the camera will be ready to use after approx. 1 s.
- The LED lights up briefly and the displays in the viewfinder appear.

#### SWITCHING THE CAMERA OFF

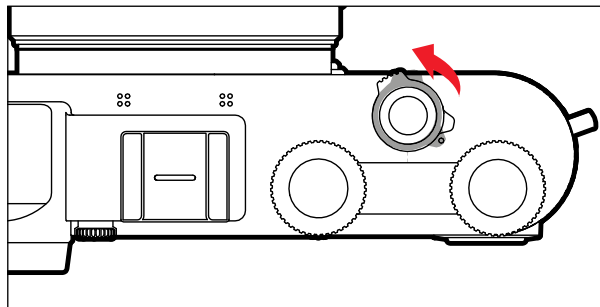

#### Note

The function **Auto Shutdown** (see p. 53) deactivates the camera automatically if no operation occurs within a preset time. Use the main switch to deactivate the camera if this function is **Off** to prevent inadvertent exposures and battery discharge when the camera is not in use.

## SHUTTER BUTTON

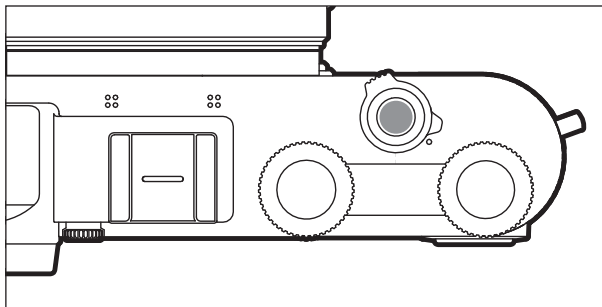

The shutter button works in two stages.

1. **Tapping** (= Pressing the shutter button to the 1st pressure point)
  - activates the camera electronics and rangefinder display
  - saves the metered exposure value in aperture priority mode, i.e. the shutter speed calculated by the camera
  - stops a running self-timer delay time
  - reverts the camera back to picture mode:
    - if playback mode is set
    - if menu control is active
    - if the camera is in Standby mode
2. **Press down fully**
  - to take the picture
    - The data is then transferred to the memory card.
  - starts a preselected self-timer delay

## Notes

- Press down the shutter button in a smooth motion until you hear the click of the shutter to prevent camera shake.
- The shutter button remains locked
  - if the memory card is inserted and the internal buffer memory is (temporarily) full.
  - if the battery has exceeded its performance limits (capacity, temperature, age).
  - if the memory card is write-protected or damaged.
  - if image numbering on the memory card has reached its limit.
  - if the camera prompts for language, date and time settings at first use or after a reset.
  - if the sensor is too hot.
- When the shutter button is released, camera electronics and viewfinder displays remain active for the time set in the main menu item **Power Saving**.

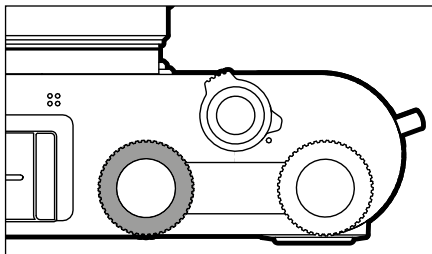
**LEFT SETTING WHEEL**

- Toggling between operating modes
- Setting of exposure compensation, aperture, shutter speed or program shift (depending on operating mode setting wheel assignments)
- Scrolling through the picture memory

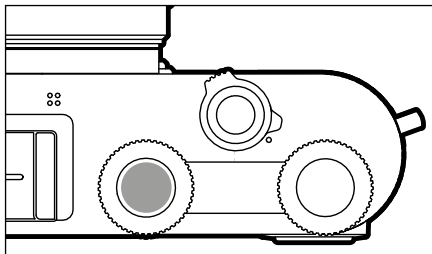
**Left setting wheel button**

- Tagging/rating of recordings
- Keylock

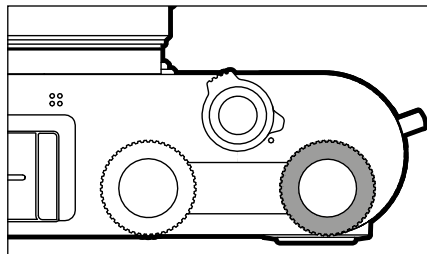
**Right setting wheel**

- Menu navigation
- Setting of exposure compensation, aperture, shutter speed or program shift (depending on operating mode setting wheel assignments)
- Enlarging/reducing viewed pictures

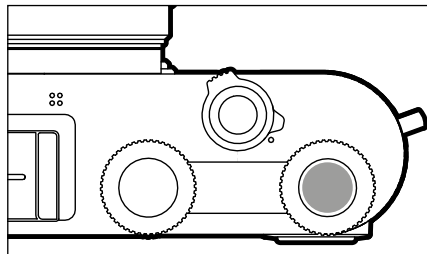
**RIGHT SETTING WHEEL BUTTON**

- Confirming the selection
- Direct access to menu functions

## SETTING WHEEL FUNCTIONS IN RECORDING MODE

The function of each of the setting wheels depends on the active operating mode.

	Left setting wheel	Right setting wheel
<b>P</b>	Exposure compensation	Mode shift
<b>S</b>	Shutter speed	Exposure compensation
<b>A</b>	Exposure compensation	Aperture
<b>M</b>	Shutter speed	Aperture
<b>AI</b>	Exposure compensation	Aperture
<b>PL</b>	Exposure compensation	Exposure compensation
<b>Sr</b>	Exposure compensation	Exposure compensation

In picture mode, the relevant function of the setting wheel is indicated on screen below the wheel, once the setting wheel is turned to the next position.

The functions of the right and left setting wheels can be swapped for the operating modes **P**, **S**, **A**, **M** and **AI**.

- ▶ Select **Customize Control** in the main menu
- ▶ Select **Wheel Assignment** in the submenu
- ▶ Select a setting

## DIRECTIONAL PAD/CENTER BUTTON

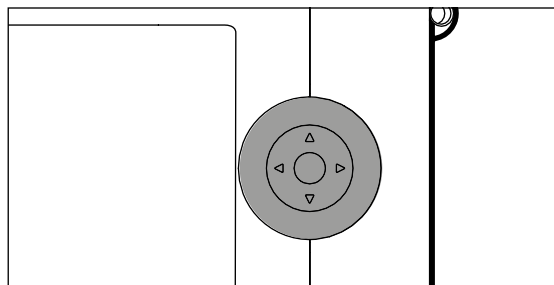

### DIRECTIONAL PAD

- Menu navigation
- Setting selected menu items/functions
- Scrolling through the picture memory
- Shifting the metering field (Field or Spot AF)

### CENTER BUTTON

- Accessing the status display
- Accessing the submenu
- Applying menu settings
- Confirming the selection
- Confirming a deletion
- Display of picture data during review
- Playback of video recordings

## PLAY BUTTON/FN BUTTON/MENU BUTTON

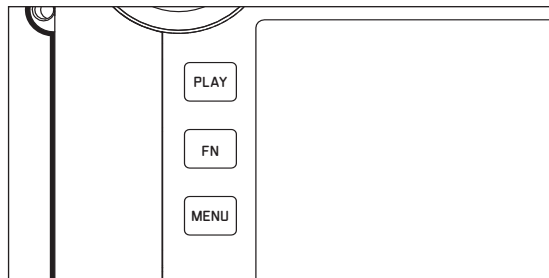

### PLAY BUTTON

- Activation and deactivation of the (continuous) review/playback mode
- Return to full-screen display

### FN BUTTON

- Direct access to menu functions
- Direct access to delete function

### MENU BUTTON

- Accessing the **Favorites** or **Main menu**
- Exiting the currently displayed (sub) menu
- Accessing the Playback/Review menu

## TOUCH SCREEN

### TOUCH CONTROL

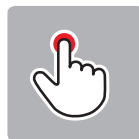

Tap briefly



Double tap



Touch and hold,  
drag and drop



horizontal/vertical  
swipe



Two-finger pinch



Two-finger spread



**In picture mode**

- Set the exposure metering field position (tap the desired location)
- Changing to video mode (horizontal swipe)
- Changing to review mode (vertical swipe)

**In Playback/Review mode**

- Changing to picture mode (vertical swipe)
- Scrolling through the picture memory (horizontal swipe)
- Zooming in/out of viewed pictures (two-finger pinch/spread)
- Setting an image area for viewfinder live zoom (double tap)

**Note**

A light touch is enough, do not press down.

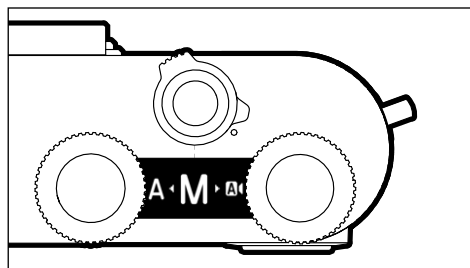
**TOP DISPLAY**

- Display when changing operating modes
- Set operating mode
- Information about aperture, shutter speed, exposure compensation and program shift (depending on the set operating mode)

## MENU CONTROL

Menu sections: **Main menu** and **Favorites**

**Main Menu:**

- contains all menu items

**Favorites:**

- your custom list (see p. 49 for details on how to manage this list)

### Note

The favorites menu can only be displayed if it has at least one menu item assigned.

## CONTROL ELEMENTS

The following elements are used for menu control.

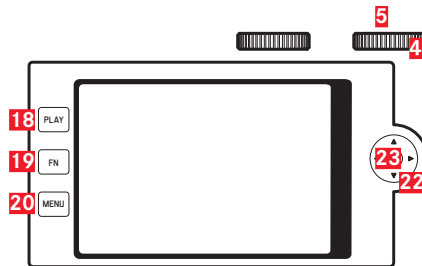

**18** PLAY button

**19** FN button

**20** MENU button

**5** Right setting wheel button

**4** Right setting wheel

**22** Directional pad

**23** Center button

## STRUCTURE OF THE MENU SCREEN

### MAIN MENU

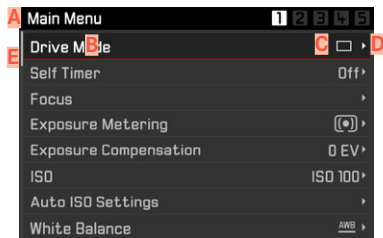

- A** Menu section: Main Menu/Favorites
- B** Menu item name
- C** Menu item setting
- D** Submenu reference
- E** Scrollbar: current position in the menu list

### SUBMENU

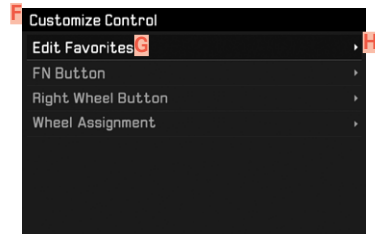

- F** Current menu item
- G** Submenu item
- H** Reference to other submenus

#### Note

In some cases, an additional scale will be available, where values can be set or function options can be selected.

## MENU NAVIGATION

### DISPLAY “HOME” SCREEN (INITIAL MENU CONTROL SCREEN)

#### In picture mode

- if there are no menu items assigned to the favorites menu:
  - ▶ Press the **MENU** button 1x
    - **Main Menu** appears.
- if at least one menu item was assigned to the favorites menu:
  - ▶ Press the **MENU** button 1x
    - **Favorites** menu appears.

#### Getting back to the main menu

- if the favorites menu consists of one page:
  - ▶ Press the **MENU** button 1x
- if the favorites menu consists of 2 pages:
  - ▶ Press the **MENU** button 2x
 or
  - ▶ **Select Main Menu** (last item in the favorites menu)

#### In Playback/Review mode

- ▶ Tap the shutter button
  - back to picture mode
- ▶ Press the **MENU** button
  - The Home screen is displayed

## SHOW SUBMENU

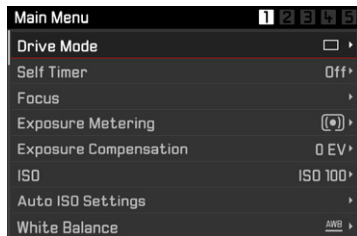

- ▶ Press the center button
- or
- ▶ Press the directional pad to the right
- or
- ▶ Press the right setting wheel button

## NAVIGATING WITHIN THE MENUS

### Page by page navigation

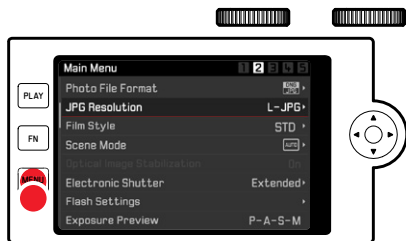

- ▶ Press the **MENU** button
  - Continuous scrolling will return the main menu to Screen 1 after Screen 5.
  - Back to the favorites menu:
    - ▶ Press the shutter button
    - ▶ Press the **MENU** button

### Line by line navigation

(Function/function option selection)

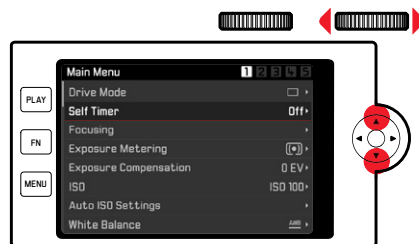

- ▶ Press the directional pad up/down
- or
- ▶ Turn the right setting wheel
    - (to the right = down, to the left = up)
    - Once the last menu item has been reached scrolling up or down, the display will automatically jump to the previous or next screen.

### Note

- Some menu items can only be accessed under specific circumstances. The text in the relevant line is displayed in gray to signify the existence of a submenu.

## CONFIRM SELECTION

- ▶ Press the center button
- or
- ▶ Press the right setting wheel button
  - The screen image changes back to the active menu item. The set function variant is shown on the right in the relevant menu line.

### Note

No confirmation is needed for the selection of **On** or **Off**. An automatic save is done.

## GO BACK ONE STEP

- ▶ Press the directional pad left
  - The directional pad is not available for this function in scale-type submenus.

## EXITING THE MENU

You can exit the menus and submenus at any time - with/without applying the settings made.

### Return to the superordinate menu item

- ▶ Press the directional pad left

### Go to picture mode

- ▶ Press the shutter button

### Go to playback mode

- ▶ Press the **PLAY** button

## OPERATING THE KEYBOARD/NUMBER PAD

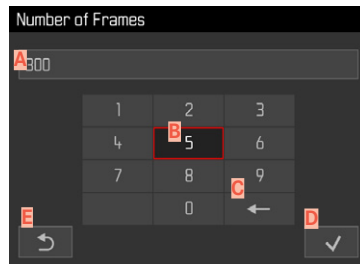
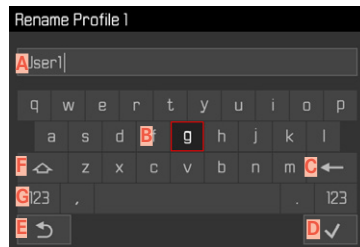

- A** Input line
- B** Keyboard/Number pad
- C** “Delete” button (deletion of the respective last value)
- D** Press “Confirm”  
(to apply individual values and the complete settings)
- E** Return to previous menu level
- F** Shift key (toggles between upper and lower case letters)
- G** Changing the character type

### Using button control

#### **To move left or right**

- ▶ Press the directional pad left/right  
or
- ▶ Turn the right setting wheel

#### **To go up or down**

- ▶ Press the directional pad up/down

#### **To toggle between upper and lower case letters**

- ▶ Use the directional pad to select “Shift” **F**
- ▶ Press the center button

#### **To change the character type (letters/numerals)**

- ▶ Use the directional pad to select the **G** key
- ▶ Press the center button

#### **To enter the selected character**

- ▶ Press the center button  
or
- ▶ Press the right setting wheel button

#### **To save**

- ▶ Use the directional pad to select the **D** key
- ▶ Press the center button

### Using touch control

- ▶ Press the button of your choice

#### **To save**

- ▶ Select button **D**

#### **To exit the menu**

- ▶ Select button **E**

## USING THE MENU BAR

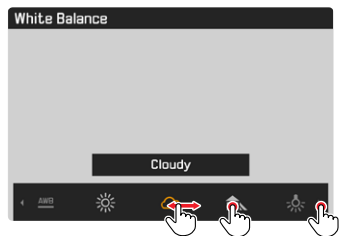

### Using button control

- ▶ Press the directional pad left/right
- or
- ▶ Turn the right setting wheel

### Using touch control

- ▶ Select the desired function or swipe

## USING THE SCALES SUBMENU

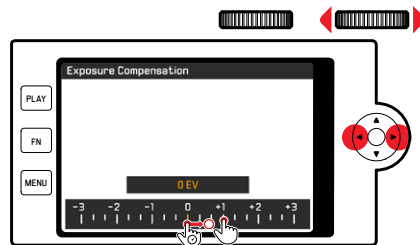

### Using button control

- ▶ Press the directional pad left/right
- or
- ▶ Turn the right setting wheel

### Using touch control

- ▶ Select the desired function or swipe

### Notes

- The currently active setting displayed in the center is highlighted in yellow.
- The set value is displayed above the scale/below the menu bar.
- The selected function requires no confirmation and will be active immediately.



## FAVORITES MENU

Assign you most frequently used menu items to a favorites menu (up to 15 items) for quick and easy access. The available functions are shown in the list on p. 146.

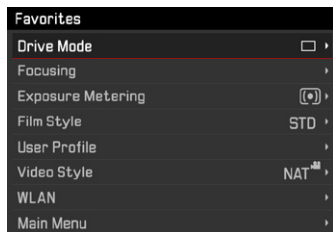

## MANAGE FAVORITES MENU

- ▶ Select **Customize Control** in the main menu
- ▶ Select **Edit favorites** in the submenu

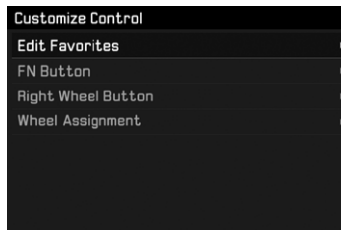

- ▶ Select the desired menu item

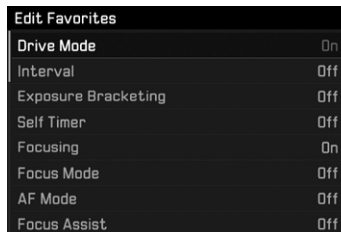

- ▶ Select **On** or **Off**
  - A warning message appears when the favorites menu has reached the maximum of 15 menu items and no further items can be added.

### Note

The favorites menu will be deleted completely if all menu items are set to **Off**.

## DIRECT ACCESS TO MENU FUNCTIONS

You can assign specific menu functions to the following operating elements for extra quick direct access to menu items in recording mode. The available functions are shown in the list on p. 146.

- **FN** button (factory setting: **Self Timer**)
- Right setting wheel button (factory setting: **ISO**)

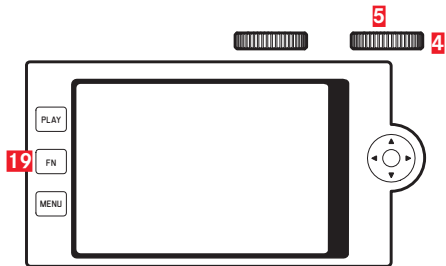

**19** FN button

**5** Right setting wheel button

**4** Right setting wheel

## Creating the custom list

- ▶ Select **Customize Control** in the main menu
- ▶ Select **FN button/Right setting wheel button** in the submenu
- ▶ Select **On** or **Off** for each menu item
  - You can activate a maximum of 8 menu items for this list.
  - The available functions are identical for both buttons.

## Changing the assignment via the custom list

- ▶ Press and **hold** the **FN** button/right setting wheel button
  - The direct access list you have created will appear on the LCD panel.
  - This list can be modified at any time via the menu item **Customized Control**.
- ▶ Select the desired menu item
  - You will not be prompted to acknowledge your selection. The change is applied immediately.

## Accessing the assigned menu function

- ▶ Press the **FN** button/right setting wheel button **briefly**
  - The assigned function is accessed, or a submenu appears on screen.
  - Settings can be done via key control or using gesture control on the LCD panel.

## KEYLOCK

Various buttons can optionally be locked in recording mode.

### LOCK ALL BUTTONS

All buttons (except the shutter button) are locked.

#### To lock all buttons

- ▶ Press and hold the left setting wheel button
  -  Appears on screen when a button is pressed while the lock is active.



#### To unlock all buttons

- ▶ Press and hold the left setting wheel button

## LOCKING THE SETTING WHEELS

The function of both setting wheels can be locked/unlocked.

### Using touch control

- ▶ Tap the relevant function display (with cogwheel icon), until /  appears at the bottom center of the screen (after approx. 2 seconds)



### Using button control

- ▶ Select **Wheel lock in Live View** in the main menu
- ▶ Select **Right wheel** or **Left wheel** in the submenu
- ▶ Select **On** or **Off**.
  - A locked setting wheel is indicated by  on screen.

## CAMERA DEFAULT SETTINGS

For details on how to navigate in the menus and for inputs see chapter "Menu control" (p. 42).

### MENU LANGUAGE

Factory setting: English

Available menu languages: German, French, Italian, Spanish, Russian, Japanese, Korean, Traditional or Simplified Chinese

- ▶ Select **Language** in the main menu
- ▶ Select your language
  - Aside from a few exceptions, the language will be changed for all information.

### DATE/TIME

#### DATE

You can choose one of 3 options.

- ▶ Select **Date & Time** in the main menu
- ▶ Select **Date Setting** in the submenu
- ▶ Select the desired date format  
(**Day/Month/Year**, **Month/Day/Year**, **Year/Month/Day**)
- ▶ Set the date

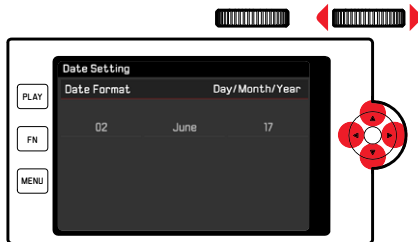

**To move to the next settings field**

- ▶ Press the directional pad left/right
- or
- ▶ turn the right setting wheel

**To set values**

- ▶ Press the directional pad up/down

**To save and return to parent menu item**

- ▶ Press the center button/right setting wheel button

## TIME

- ▶ Select **Date & Time** in the main menu
- ▶ Select **Time Setting** in the submenu
- ▶ Select the desired display format  
(**12 Hours**, **24 Hours**)
- ▶ Set the time  
(Select **am** or **pm** for the 12-hour format)

## TIME ZONE

- ▶ Select **Date & Time** in the main menu
- ▶ Select **Time zone** in the submenu
- ▶ Select your time zone/current location
  - The Greenwich Mean Time offset is shown on the left of the line
  - Major cities in the relevant time zones are shown on the right

## DAYLIGHT SAVING TIME

- ▶ Select **Date & Time** in the main menu
- ▶ Select **Daylight Saving Time** in the submenu
- ▶ Select **On** or **Off**.

## POWER SAVE MODE (STANDBY MODE)

The camera will switch to the power-saving standby mode after a preset time to extend battery life if this function is activated. The device has two power save levels.

- Standard Save mode:  
Activation of the stand-by mode after 2/5/10 minutes.
- Automatic LCD panel shutdown (see p. 56)

## ACTIVATE/DEACTIVATE FUNCTION

Both functions are activated/deactivated concurrently.

- ▶ Select **Power Save** in the main menu
- ▶ Select **Power Save Mode**
- ▶ Select **On/Off**

## STANDARD SAVE MODE

- ▶ Select **Power Save** in the main menu
- ▶ Select **Auto Power Off**
- ▶ Select the desired setting  
(**Off**, **2 min**, **/5 min**, **/10 min**)

### Note

The camera can be reactivated from standby mode at any time by pressing the shutter button or by switching the main switch off and on again.

## LCD PANEL/VIEWFINDER (EVF) SETTINGS

The camera comes equipped with a 3" LCD color screen. The following functions can be configured and used individually:

- Use of the LCD panel and EVF (electronic viewfinder)
- Eye sensor sensitivity
- Brightness
- Information display
- Automatic LCD panel shutdown (standby mode)

## LCD PANEL/EVF USE

You can preset the situations in which EVF and LCD panel should be used. The displays appearing on screen and in the viewfinder are identical.

Factory setting: **Auto**

	EVF	LCD panel
Auto	The eye sensor in the viewfinder automatically toggles the camera between LCD panel and EVF. <ul style="list-style-type: none"> <li>• Pictures</li> <li>• Playback</li> <li>• Menu control</li> </ul>	
LCD		<ul style="list-style-type: none"> <li>• Pictures</li> <li>• Playback</li> <li>• Menu control</li> </ul>
EVF	<ul style="list-style-type: none"> <li>• Pictures</li> <li>• Playback</li> <li>• Menu control</li> </ul>	
EVF Extended	<ul style="list-style-type: none"> <li>• Pictures</li> </ul>	<ul style="list-style-type: none"> <li>• Playback</li> <li>• Menu control</li> </ul>

- ▶ Select **Display Settings** in the main menu
- ▶ Select **EVF-LCD** in the submenu
- ▶ Select a setting

### Note

Select **EVF** if you want to keep the LCD panel switched off (e.g. on dark environments).

## EYE SENSOR SENSITIVITY

You can adjust the eye sensor sensitivity to ensure that the changeover functions reliably if you wear eyeglasses.

Factory setting: **Low**

- ▶ Select **Display Settings** in the main menu
- ▶ Select **Eye Sensor Sensitivity** in the submenu
- ▶ Select a setting

## BRIGHTNESS

You can adjust brightness for best visibility in various lighting conditions. It is set individually for the LCD panel, top display and the viewfinder.

### LCD PANEL

- ▶ Select **Display Settings** in the main menu
- ▶ Select **LCD Brightness** in the submenu
- ▶ Select the desired brightness or **Automatic**
- ▶ Confirm selection

### EVF

- ▶ Select **Display Settings** in the main menu
- ▶ Select **EVF Brightness** in the submenu
- ▶ Look through the viewfinder
- ▶ Select the desired brightness
- ▶ Confirm selection

### Note

The **Automatic** setting is not available here.

### TOP DISPLAY

- ▶ Select **Display Settings** in the main menu
- ▶ Select **Top Display** in the submenu
- ▶ Select the desired function
  - **On**: always on
  - **Off**: always off
  - **Auto**: automatic control depending on ambient brightness

## INFORMATION DISPLAYS

The picture data can be displayed in picture mode and in review mode.

### DISPLAY OPTIONS

Two display options are available.

- No information display
  - With picture data in the header and footer line
- ▶ Press the center button
- The display cycles through the display options.

### Notes

- Only information about exposure are displayed during exposure metering (shutter button held on first pressure point), regardless of the setting.
- All displays are visible at all times in video mode.

## AUTOMATIC DEACTIVATION OF ALL DISPLAYS

This function allows you to set a time after which the top display, screen and viewfinder are powered down to extend battery life.

- ▶ Select **Power Save** in the main menu
- ▶ Select **All Displays Auto Off**
- ▶ Select the desired setting  
(**30 s**, **1 min**, **5 min**)



## ACOUSTIC SIGNALS

Some functions can be acknowledged with acoustic signals. The following special functions can be configured separately:

- Electronic shutter sound
- AF confirmation

## ACOUSTIC SIGNALS

As a warning signal, e.g. when the user attempts to configure unavailable settings.

- ▶ Select **Acoustic Signals** in the main menu
- ▶ Select **Acoustic Signals** in the submenu
- ▶ Select **On**
- ▶ Select **Volume** in the submenu
- ▶ Select **Low/High**

## ELECTRONIC SHUTTER SOUND

- ▶ Select **Acoustic Signals** in the main menu
- ▶ Select **Electronic Shutter Sound** in the submenu
- ▶ Select **On**
- ▶ Select **Volume** in the submenu
- ▶ Select **Low/High**

## AUTOFOCUS CONFIRMATION

A signal sound can be selected for successful AF settings.

- ▶ Select **Acoustic Signals** in the main menu
- ▶ Select **AF Confirmation** in the submenu
- ▶ Select **On**
- ▶ Select **Volume** in the submenu
- ▶ Select **Low/High**

## SILENT PHOTOGRAPHY

When pictures should be taken as quietly as possible.

- ▶ Select **Acoustic Signals** in the main menu
- ▶ Select **Electronic Shutter Sound/AF Confirmation/Acoustic Signals** in the submenu
- ▶ Select **Off** for each of these menu items

## BASIC PICTURE SETTINGS

### PHOTO

#### FILE FORMAT

Choose the JPG format **JPG** or the standardized raw data format **DNG** (= digital negative). These can be used individually or simultaneously.

Factory setting: **DNG + JPG**

- ▶ Select **Photo File Format** in the main menu
- ▶ Select the desired format  
**(DNG, DNG + JPG, JPG)**

#### Notes

- The standardized DNG (Digital Negative) format is generally used for the storage of raw data.
- When picture data is saved in **DNG** and in **JPG** format simultaneously, then the camera will use the resolution setting for the **JPG** format is used for the JPG file (see next section), i.e. the two files may have differing resolutions.
- The **DNG** format always uses the highest resolution (24 MP), no matter what **JPG** setting is selected.
- The remaining number of pictures shown in the LCD panel will not necessarily change after every picture taken. A counter change depends on the subject; very fine image structures result in higher data quantities, while homogeneous surfaces mean less data.

### JPG RESOLUTION

The **JPG** format setting offers 3 image resolution (number of pixels) options. The following file formats are available: **L-JPG** (24 MP), **M-JPG** (12 MP) and **S-JPG** (6 MP). You can therefore adjust your settings to the intended use and available memory card capacity.

- ▶ Select **JPG resolution** in the submenu
- ▶ Select the desired resolution

## IMAGE PROPERTIES

One of the many advantages of digital photography is that it is very easy to change key image properties.

You can manipulate contrast, sharpness and color saturation before the picture is taken.

### Note

The functions and settings described in this section apply for pictures taken in **JPG** format only.

## CONTRAST

The contrast setting, i.e. the difference between light and dark image sections, determines whether an image comes across as “flat” or “brilliant”. Increasing or decreasing this difference impacts on contrast, meaning that some image sections are rendered with more or less light.

## SHARPNESS

The impression of sharpness in a picture is largely determined by edge sharpness, i.e. by how slight the transition area between light and dark is at edges in the picture. Expanding or reducing these areas will therefore change the impression of sharpness.

## COLOR SATURATION

The saturation factor in color images determines, whether colors in the picture appear “pale” and pastel-like or “bright” and colorful. While you can't do anything about weather conditions (clear/misty), you can change the way an image is rendered.

## COLOR PROFILE

Three pre-configured color profiles are available:

Factory setting: **Standard**

- **STD** **Standard**
- **VIV** **Vivid**
- **STD** **Natural**

- ▶ Select **Film Style** in the main menu
- ▶ Select a profile

## MONOCHROME PROFILE

You can choose to save your images in color or monochrome, provided you take the pictures in JPG format.

Two pre-configured monochrome profiles are available:

- **BW** **Monochrome**
- **BW** **Monochrome HC**

- ▶ Select **Film Style** in the main menu
- ▶ Select a profile

## Customizing photo profiles

Additionally, you can adjust the values for contrast, sharpness and saturation (saturation only for color pictures) for each profile separately.

- ▶ Select **Film Style** in the main menu
- ▶ Select **Film Style Settings** in the submenu
- ▶ Select a profile from the submenu
- ▶ Select **Contrast/Sharpness/Saturation** in the submenu
- ▶ Select a level  
(**Low**, **Medium low**, **Standard**, **Medium high**, **High**)

## IMAGE STABILIZATION

The less favorable the lighting conditions during recording, the slower will be the required shutter speeds for correct exposure. Visual image stabilization is a great tool for preventing out-of-focus images due to blurring.

When using Leica SL lenses equipped with OIS, your Leica CL can utilize their built-in stabilization function.

Factory setting: **Auto**

- ▶ Select **Visual Image Stabilization** in the main menu
- ▶ Select **On** or **Off**.

### Note

Please read the relevant lens manual for more information about OIS.

## VIDEO

### FILE FORMAT

Videos are recorded in MP4 format.

### VIDEO RESOLUTION

Factory setting: **Full HD / 60 fps**

Choose one of three resolution levels, one of which offers two frame rates:

<b>4K / 30 fps</b>	(3840 x 2160 pixels)
<b>Full HD / 60 fps</b>	(1920 x 1080 pixels)
<b>Full HD / 30 fps</b>	(1920 x 1080 pixels)
<b>HD / 30 fps</b>	(1280 x 720 pixels)

You can therefore adjust your settings to the intended use and available memory card capacity.

- ▶ Select **Video Resolution** in the main menu
- ▶ Select the desired resolution

(**4K / 30fps**, **Full HD / 60fps**, **Full HD / 30 fps**, **HD / 30 fps**)

#### Note

The max. file size for uninterrupted video recording is 96 GB. Once a recording exceeds this file size, the overrun will be automatically stored in a new file (but cannot be longer than 29 min).

## MICROPHONE

Sound is recorded in stereo via the built-in microphones. You can configure the sensitivity setting of the built-in microphone.

Factory setting: **Medium**

- ▶ Select **Video Settings** in the main menu
- ▶ Select **Microphone Gain** in the submenu
- ▶ Select the desired level  
(**High**, **Medium**, **Medium low**, **Low**, **Off**)

#### Note

The Autofocus function and manual focal length adjustments generate noise that may be picked up in the recording.

## WIND NOISE REDUCTION

Factory setting: **On**

- ▶ Select **Video Settings** in the main menu
- ▶ Select **Wind Noise Reduction** in the submenu
- ▶ Select **On** or **Off**.

## VIDEO STABILIZATION

The stabilization function helps to reduce blurring for handheld recordings.

- ▶ Select **Video Settings** in the main menu
- ▶ Select **Video Stabil.** in the submenu
- ▶ Select **On** or **Off**.

### Note

The image section is reduced slightly when using the video stabilization function.

## IMAGE PROPERTIES

The color space is set to sRGB for video recording. Other image properties can be set for video recordings.

## VIDEO PROFILES

Three pre-configured color profiles are available:

- STD **Standard**
- VIV **Vivid**
- NAT **Natural**

There are two additional profiles available for monochrome video recordings:

- BW **Monochrome**
- BW **Monochrome HC**

- ▶ Select **Video Style** in the main menu
- ▶ Select a video profile

## CUSTOMIZING VIDEO PROFILES

Additionally, you can adjust the values for contrast, sharpness and saturation (saturation only for color pictures) for each profile separately.

- ▶ Select **Video Style** in the main menu
- ▶ Select **Video Style Settings** in the submenu
- ▶ Select a video profile from the submenu
- ▶ Select **Contrast/Sharpness/Saturation** in the submenu
- ▶ Select a level  
(**Low**, **Medium low**, **Standard**, **Medium high**, **High**)

## PICTURE MODE

### FOCUSING

Your Leica CL allows automatic as well as manual focusing. There are 2 operating modes and 3 metering methods available for AF photography.

### PHOTOGRAPHY WITH AF

- ▶ position the AF metering field as needed
- ▶ Tap and hold the shutter button
  - Focusing occurs one time (AFs) or continuously (AFc).
  - Metering was successful: The AF metering field lights up green.
  - Metering was unsuccessful: The AF metering field lights up red.
  - Alternatively, focus settings and/or exposure settings can be done and saved via the right setting wheel button or the FN button (metering memory lock, see p. 84).
- ▶ Shutter release

### PHOTOGRAPHY WITH MF

- ▶ Use the focus ring to manually focus on the object
- ▶ Shutter release

Please read the following chapters for more information.

## AUTOFOCUS MODES

The following AF modes are available: **AFs** and **AFc**. The currently selected AF mode is shown in the header line.

### AFs (single)

Suitable for objects with little or no movement. Focusing is done only once and the setting remains as long as the shutter button is held at the pressure point. That also applies if the AF metering field is pointed at another object.

### AFc (continuous)

Suitable for objects in motion. As long as the shutter button is held at the 1st pressure point, focusing is continuously adjusted to the object in the AF metering field.

- ▶ Select **Focusing** in the main menu
- ▶ Select **Focus Mode** in the submenu
- ▶ Select a setting



## AUTOFOCUS METERING METHODS

The AF mode offers various metering methods for focusing. A successful focus setting is identified by a green metering field, an unsuccessful one is shown in red.



- ▶ Select **Focusing** in the main menu
- ▶ Select **AF Mode** in the submenu
- ▶ Select a setting  
(**Multi-Field**, **Spot**, **Field**, **Tracking**, **Face Detection**)

### Notes

- AF focusing can be unsuccessful:
  - If the distance to the subject is too great or too small
  - If the object is not sufficiently illuminated
- You can also use the focus setting ring on the lens to manually change the automatically set focus while the shutter button is pressed to the first pressure point.
- Only manual focusing is available when using Leica M or R lenses with the optional Leica M or R Adapter L.

## MULTI-FIELD METERING

Several metering fields are detected automatically. This function is particularly useful for snapshots.

## SPOT/FIELD METERING

Both methods detect only those parts of the object that are within the relevant AF metering fields. The metering fields are indicated by a small frame (field metering) or a cross (spot metering). The very small measuring range for spot metering allows focusing on tiny details of the subject.

The slightly larger measuring range in field metering is less critical for focusing, but still permits selective metering.

These metering methods can also be used for serial exposures in which the part of the object you want to focus on will always be at the same off-center position in the image.

Simply move the AF metering field to another position.

- ▶ Press the directional pad left or right as needed  
or
- ▶ Briefly tap the LCD panel  
(while Touch AF is activated)

### Note

In both cases, the metering fields remain at their last positions set, even if the metering method is changed or the camera is switched off.

## TRACKING

This field metering variant helps in the capture of moving objects. The focus on the object in the metering field is continuously adjusted, once it is detected.

- ▶ Aim the metering field at the desired object  
(by panning the camera shifting the metering field)
- ▶ Tap and hold the shutter button

or

- ▶ Press the right setting wheel button/**FN** button  
(provided the **AF-L** or **AF-L + AE-L** is assigned to the button, see p. 84)
  - The camera focuses on the object.
- ▶ Pan the camera to the desired cropped section
  - The metering field "tracks" the saved object and focus is continuously adjusted.

### Note

- This metering method focuses continuously, even if the AF mode **AFs** was set.

## FACE DETECTION

In this metering method, the Leica CL automatically detects faces in the image field. The focus is set automatically on the faces closest to the camera. Multi-field metering is used if no faces are detected.



When focusing is successful, the AF metering field changes from yellow to green.

## TOUCH AF

Touch AF allows a direct placement of the AF metering field.

- ▶ Select **Focusing** in the main menu
  - ▶ Select **Touch AF** in the submenu
  - ▶ Select **On/Off**
- ▶ Briefly tap the LCD panel in the desired position

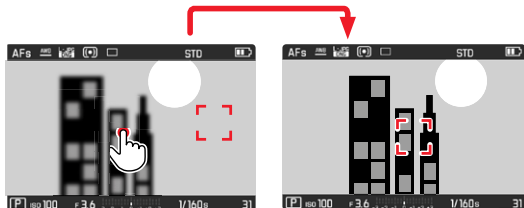

To move the metering field back to the center of the screen

- ▶ Double tap the LCD panel

### Notes

- This function is available in conjunction with the AF metering methods Spot metering, Field metering and Tracking.
- With Spot or Field metering selected, the camera will focus again automatically. If the metering method **Tracking** is selected, the metering field will remain at the selected position and autofocus commences when the shutter button is tapped.

## LIMITING THE AUTOFOCUS SETTING RANGE

The autofocus system takes longer to run through the complete setting range, i.e. from the closest focusing distance to infinity when focusing macro lenses (with typically very short closest focusing distance) or with lenses with a longer focal length. Some Leica TL lenses<sup>1</sup> allow a limiting of their setting ranges to speed up focusing. This is advisable if you know that you will only need the close range or only the long range for specific exposures.

### Activating the function

- ▶ Select **Focusing** in the main menu
- ▶ Select **Focus Limit** in the submenu
- ▶ Select **On** or **Off**.

### Using the function

Whether the **Focus Limit** function should limit automatic focusing to close range or long range depends first of all on the current lens setting. You can, however, change from the preset setting range to another by turning the focus setting ring. The following table illustrates the correlations.

<sup>1</sup> Version 31.7.2017: Leica APO-Macro-Elmarit-TL 60 f/2.8 ASPH., Leica Vario-Elmar-TL 55-135 f/3.5-4.5 ASPH.

Lens setting	Focus Limit is activated	Changing the focus range (turning the lens focus ring)
working with shorter ranges	Autofocus applies only for set <b>short range</b>	Focusing “jumps” to <b>long range</b> (Autofocus is limited to long range)
working with longer ranges	Autofocus applies only for set <b>long range</b>	Focusing “jumps” to <b>short range</b> (Autofocus is limited to short range)

### Notes

- The **Focus Limit** function is also available for specific Leica SL lenses (see relevant manual), but not for lenses attached via an adapter.
- The **On** setting of the function is reset to **Off** if the lens is changed while the camera is switched on.

## MF ASSIST FUNCTIONS

### AF ASSIST LIGHT

The integrated AF assist light allows operation of the AF system in unfavorable lighting conditions. This light comes on as soon as the shutter button is pressed, provided the function is activated.

- ▶ Select **Focusing** in the main menu
- ▶ Select **AF Assist Light** in the submenu
- ▶ Select **On/Off**

### Note

- The AF assist light illuminates an area of up to approx. 4 m.
- The AF assist light switches off automatically, once focusing was successful (AF metering field is green) or has failed (AF metering field is red).

### ACOUSTIC AF CONFIRMATION

A successful focus metering in AF mode can be confirmed with an acoustic signal (see p. 57).

## MANUAL FOCUSING (MF)

Focusing manually may in some situations be a better choice than autofocus.

- the same setting is used for several exposures
- it would take longer to use the metering memory lock function
- the setting is to be kept at infinity for landscape pictures
- poor, i.e. very dark lighting conditions prevent AF operation or would slow it down

- ▶ Select **Focusing** in the main menu
  - ▶ Select **Focus Mode** in the submenu
  - ▶ Select **MF**
- 
- ▶ Turn the focus ring until the desired part of the object is in clear focus

### Note

Manual focusing is possible in auto focus mode as well – with the shutter button pat the first pressure point.

## MF ASSIST FUNCTIONS

The following assist functions are available in MF mode.

### FOCUS PEAKING

This assist function highlights in focus object sections in color. The color can be freely selected. The sensitivity can be additionally adjusted.

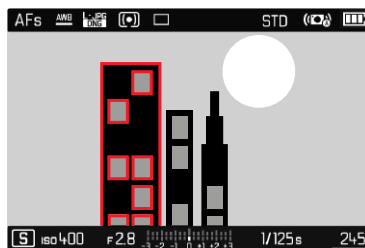

- ▶ Select **Focusing** in the main menu
- ▶ Select **Focus Assist** in the submenu
- ▶ Select **Focus Peaking**
- ▶ Select a setting  
(Off, Red, Green, Blue, White)

## Setting the sensitivity

- ▶ Select the **Sensitivity**
- ▶ Select the desired setting  
(Low/High)

### Note

Focus peaking is based on subject contrast, i.e. differences between light and dark. As a result, high contrast subject parts could be marked, even if they are not completely in focus.

## ENLARGEMENT

Turning the focus ring will automatically enlarge the image section in the center, which means the focus quality can be better assessed.

Any image section can be selected for checking correct focus. Selection occurs via key control or touch control.

- ▶ Select **Focusing** in the main menu
- ▶ Select **Focus Assist** in the submenu
- ▶ Select **Auto Magnification**
- ▶ Select **On**
- ▶ Turn the focus ring
  - The image section in the center is enlarged x3 and an indicator showing the magnification factor is shown at the top right of the image.
- ▶ Press the center button
  - The image section toggles between magnification factors (3x/6x).
- ▶ Tap the shutter button
  - The image is no longer enlarged.

### To shift the enlarged cropped section

- ▶ Press the directional pad left or right as needed
- or
- ▶ Swipe

### Notes

- The enlargement will automatically return to normal viewing size about 5 s after the last turn of the focus ring.
- The last selected zoom level appears after the next turn.

## ISO SENSITIVITY

The ISO setting covers a range between ISO 100 and ISO 50000, allowing you to adapt to the relevant situation as required.

Factory setting: **Auto ISO**

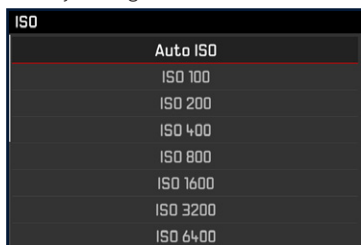

ISO
Auto ISO
ISO 100
ISO 200
ISO 400
ISO 800
ISO 1600
ISO 3200
ISO 6400

### AUTOMATIC SETTING: **Auto ISO**

In addition to the fixed settings, the function **Auto ISO** is available, which adapts the sensitivity automatically to ambient brightness or to the configured shutter speed/aperture settings combination.

There is more leeway for the use of preferred shutter speed and aperture combinations when setting the exposure manually. You can set priorities within the scope of the automatic setting, e.g. for reasons of picture composition.

- ▶ Select **ISO** in the main menu
- ▶ Select **Auto ISO** in the submenu

## LIMITING SETTING RANGES

A max. ISO value can be set, which will then limit the automatic setting range (**Max. ISO value**). A max. exposure time can also optionally be configured. There are focal length related settings (**1/f**, **1/(2f)**, **1/(3f)**, **1/(4f)**) and fixed max. shutter speeds **1/2** and **1/500** s available for that purpose.

- ▶ Select **Auto ISO Settings** in the main menu
- ▶ Select **Maximum ISO**, or **Min. Shutter Speed** in the submenu
- ▶ Select the desired value

## FIXED ISO VALUES

There is more leeway for the use of preferred shutter speed and aperture combinations when setting the exposure manually. You can set priorities within the scope of the automatic setting, e.g. for reasons of picture composition. Values between ISO 100 and ISO 50000 can be selected in 10 increments.

- ▶ Select **ISO** in the main menu
- ▶ Select the desired setting in the submenu

### Note

When high ISO values are used or the image is edited later, image noise, as well as vertical and horizontal stripes may become visible, particularly in larger, evenly lit areas of the object.

## WHITE BALANCE

In digital photography, white balance ensures neutral color rendering in any light. White balance is based on the camera being preset to render a particular light color as white.



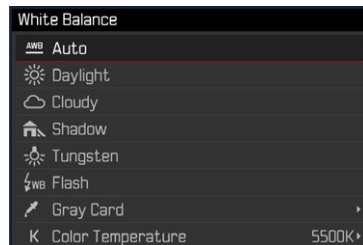

Four methods are available:

- automatic control
- fixed presets
- manual setting via metering
- direct setting of the color temperature

## AUTOMATIC CONTROL/FIXED SETTINGS



- **Auto**: for automatic control, which delivers neutral results in most situations
- Various fixed presets for most frequently encountered light sources:

 <b>Daylight</b>	for outdoor pictures in sunlight
 <b>Cloudy</b>	for outdoor pictures in cloudy conditions
 <b>Shadow</b>	for outdoor pictures with the main subject in shadow
 <b>Tungsten</b>	for indoor pictures with (predominantly) incandescent lamp light
 <b>Flash</b>	for flash photography

- ▶ Select **White Balance** in the main menu
- ▶ Select a setting



## MANUAL SETTING VIA METERING

(  **Gray Card** )

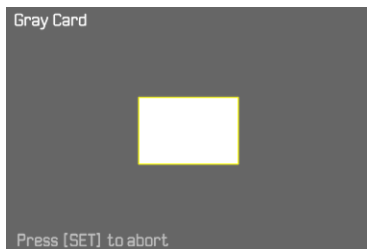

- ▶ Select **White Balance** in the main menu
- ▶ Select  **Gray Card** in the submenu
- ▶ Take the picture
  - Make sure that the image field contains a white or neutral gray (reference) surface.
  - The following will appear on the LCD panel:
    - the image based on automatic white balance
    - a frame in the center of the image
- ▶ Shutter release

### Note

A value configured using this method will remain unchanged (i.e. it will be used for all subsequent photographs) until new measurements are taken or one of the other white balance settings is selected.

## DIRECT SETTING OF THE COLOR TEMPERATURE

Values between 2000 and 11,500 K (Kelvin) can be set directly. That gives you a very wide range, which covers virtually all color temperatures occurring in real life and within which you can adapt color rendering to any light color and your personal preferences with incredible detail.

Color Temperature

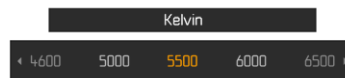

- ▶ Select **White Balance** in the main menu
- ▶ Select **Color Temperature** in the submenu
- ▶ Select the desired value

## EXPOSURE

### EXPOSURE METERING METHODS

Optional methods are spot metering, center-weighted metering and multi-field metering.

- ▶ Select **Exposure Metering** in the main menu
- ▶ Select a metering method

(Spot, Center-Weighted, Multi-Field)

- The selected metering method is displayed in the header line of the screen image.

#### Note

The right shutter speed for correct exposure or the deviation from a correct exposure setting is shown or determined with the help of the screen display.

### SPOT METERING –

Spot metering only captures and analyzes a small area in the middle of the screen image, which is shown in a circle.

### CENTER-WEIGHTED METERING –

This method considers the entire image field. The subject elements captured in the center will, however, impact on the calculation of the exposure value more so than areas around the edges.

### MULTI-FIELD METERING –

This metering method is based on the detection of multiple values. These values are used in an algorithm to calculate an exposure value appropriate for a good rendering of the assumed main subject.

## EXPOSURE MODES

There are four exposure modes available to adjust the rendering of the object or to create the desired picture composition:

- Automatic program (P)
- Aperture priority mode (A)
- Shutter priority mode (S)
- Manual setting (M)

## SELECTING A MODE

- ▶ Press the left setting wheel button
  - The currently selected mode is shown in the top display.
- ▶ Turn the left setting wheel to select the desired mode.
  - The mode display changes in the top display and on screen. All modes can be reached by turning the wheel in either direction.
  - The selected mode will be applied automatically approx. 2 s after the setting wheel is moved the last time.

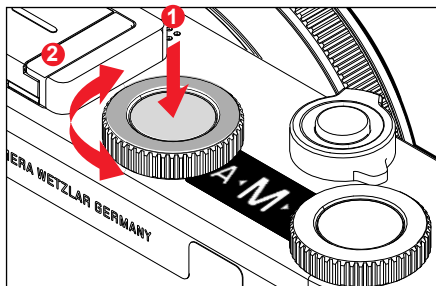

## To apply the selected mode immediately

- ▶ Press the left setting wheel button or the shutter button

## Notes

- Only **A** and **M** are available when using Leica M or R lenses with a Leica M adapter L or Leica R adapter L, i.e. **P**, **S** or **Scene Mode** are unavailable. The camera will automatically switch to **A** when the adapter is attached if **P**, **S** or a **Scene Mode** is selected. Where that is the case, **F0.0** is displayed as the aperture value.
- Should a Leica TL or SL lens be attached again later, and you want to use **P**, **S** or a **Scene Mode**, then you will have to set the desired mode again.

## FULLY AUTOMATIC EXPOSURE SETTING – P

### AUTOMATIC PROGRAM – P

The automatic program mode facilitates fast and fully automatic photography. The exposure is controlled by an automatic shutter speed and aperture setting.

- ▶ Selecting the operating mode **P** (see p. 75)
  - ▶ Tap and hold the shutter button
    - The automatically set value pair for aperture setting and shutter speed are displayed.
  - ▶ Shutter release
- or
- ▶ Adjusting the automatically set value pair

## CHANGING THE PRESET SHUTTER SPEED/ APERTURE COMBINATIONS (SHIFT)

Changing the preset values using the Shift function combines the reliability and speed of fully automatic exposure control with the opportunity to vary the speed/aperture combination selected by the camera at any time to fit in with your own ideas and intentions. The overall exposure, i.e. the brightness of the image, remains unchanged. Faster shutter speeds are a good choice for e.g. sports pictures, while longer speeds will offer more depth of field for e.g. landscape pictures.

- ▶ Turn the right setting wheel to the left/right (right = greater depth of field with slower shutter speed, left = faster shutter speed with less depth of field)
  - Shifted value pairs are marked with an asterisk next to the **P**.

### Note

The adjustment range is limited to guarantee correct exposure.

## SCENE MODE

13 additional automatic program variants are available under the menu item **Scene Modes**. All 13 offer automatically controlled shutter speed and aperture for extra easy photography as with the "normal" automatic program **P** and a number of additional optimized functions for the selected scene type.

Factory setting: **Fully automatic**

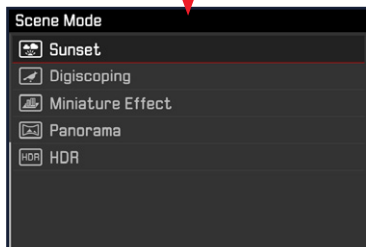
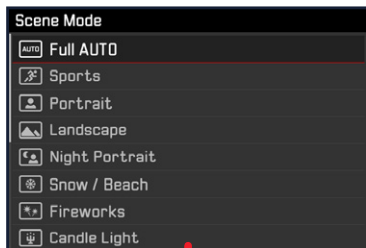

- ▶ Select **Scene Mode** in the main menu
  - ▶ Select the desired setting in the submenu
  - ▶ Select the operating mode **Sf** (see p. 75)
- **Fully automatic**: Automatic snapshot function for general use
  - 9 scene modes to match the special requirements of common scene types:
    - **Sports, Portrait, Landscape, Night Portrait, Snow/Beach, Fireworks, Candlelight, Sunset, Digiscoping**
  - 3 additional "special" modes:
    - **Miniature Effect**: Limitation of the sharpness range to one horizontal or vertical stripe within the image field
    - **Panorama**: Automatic creation of panorama pictures
    - **HDR**: automatic combination of multiple pictures taken with different exposure values

The following sections offer detailed information about these three functions.

## Notes

- The camera switches automatically to operating mode **S** if **Scene mode** is accessed directly (see p. 50).
- The selected program will remain active until a different program is selected (even after the camera is switched off).
- The program shift function and some of the menu items are unavailable.
- A fixed camera setup on a tripod is recommended for the **Digiscoping** setting.
- Exposure compensation can be set in all modes via the setting wheels (with the exception of **Miniature Effect**).
- In **Digiscoping** mode, the shutter speed can also be set via the left setting wheel.

Exposure simulation is active in all modes (see p. 83).

## MINIATURE EFFECT

The effect will make the picture look similar to a closeup photo with its characteristically shallow depth of field. Normal sized objects will appear like a model landscape in the image.

The in-focus areas can be limited optionally to a horizontal or vertical stripe. The width and position of these stripes can be adjusted within the image field.

- ▶ Select **Scene Mode** in the main menu
- ▶ Select **Miniature Effect** in the submenu
  - A frame around the area that should be in focus appears in the screen image.

### Note

When the auxiliary displays are deactivated, the frame will only be visible as long as the shutter button is held at the first pressure point. The position and width settings will still function as described.



to switch to a vertical frame

- ▶ Press the directional pad left/right

to switch to a horizontal frame

- ▶ Press the directional pad up/down

Changing the frame position

- ▶ Press the directional pad left or right as needed

Changing the frame width

- ▶ Turn (any) setting wheel  
to the left = smaller, to the right = larger)

## PANORAMA IMAGES

The Leica CL can capture classic horizontal, as well as vertical panorama images.

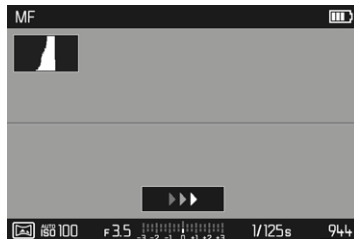

- ▶ Select **Scene Mode** in the main menu
- ▶ Select **Panorama** in the submenu
  - Auxiliary displays appear on screen
    - a white horizontal/vertical line
    - a progression display indicating the direction
- ▶ Align the camera in such a way that the desired left/bottom edge of the image is not all the way at the left/bottom of the screen image
- ▶ Press and hold the shutter button
- ▶ Pan the camera evenly in the indicated direction along the white auxiliary line
  - Pictures are taken automatically and in quick succession.
  - The image picture is canceled if the camera is panned too slowly or too fast, or if it is tilted too much and a relevant notification will appear on screen.
- ▶ Release the shutter button to stop the picture series
  - The camera generates a single image from the picture series.

## Switching between landscape or portrait orientation

- ▶ Press the directional pad

### Notes

- When the auxiliary displays are deactivated, the auxiliary line will only be visible as long as the shutter button is held at the first pressure point.
  - The less steady the camera is held along the horizontal line, the smaller will be the overall height of the panorama picture.
  - The maximum panning angle is approx. 180°.
  - Panorama pictures are always taken in automatic program mode, no matter what the settings for the shutter speed setting dial and the aperture setting wheel are.
  - Panorama pictures are always stored in **JPEG** file format regardless of the current menu setting.
  - Panorama pictures cannot be taken with a flash.
  - The resolution of a panorama picture depends on the direction of the picture and number of pictures taken.
  - Sharpness, white balance and exposure for all pictures are set to the values of the first picture taken in the series. That is why the final panorama picture may not be in perfect focus or have ideal brightness if there are significant changes in the distance between camera and object or the ambient light while the picture is taken.
  - Some objects in the picture may appear distorted or there may be visual transitions, because the panorama picture is composed of a series of individual exposures.
- Panorama pictures may not be possible for the following object types, under the following exposure conditions or the individual images may not be joined up correctly if:
    - Single-color objects or objects with a uniform pattern (sky, beach, etc.)
    - Moving objects (people, pets, vehicles, waves, flowers swaying in the wind, etc.)
    - Objects with changing colors or patterns (e.g. a TV image)
    - Dark locations
    - Objects illuminated by uneven, flickering light sources (e.g. fluorescent lamps, candlelight, etc.)



## HDR

**HDR** generates a picture in which the “overlay” of three different exposures (-2 EV/0 EV/+2 EV) reproduces an improved image of lighter and darker parts of the object, i.e. with less overexposure in the highlights and more definition in the darkest areas.

Due to the consecutive exposures, this operating mode is best suited for immobile objects or those with very little movement, e.g. landscapes. We recommend the use of a tripod for HDR pictures because of the slower shutter speeds and in particular in low ambient light.

- ▶ Select **Scene Mode** in the main menu
- ▶ Select **HDR** in the submenu

## SEMI-AUTOMATIC EXPOSURE SETTING – A/S

### SHUTTER SPEED PRIORITY – S

Shutter speed priority mode will set exposure automatically according to the manually selected shutter speed. It is therefore particularly suitable for pictures of moving objects, where the sharpness of the movement depicted is a critical picture composition element.

An appropriately fast shutter speed can help to avoid e.g. unwanted motion blurring and will “freeze” the object. Conversely, an appropriately longer shutter speed can help create a better feeling of motion in the image with targeted “tracer effects”.

- ▶ Select the operating mode **S** (see p. 75)
- ▶ Select the desired shutter speed via the left setting wheel
- ▶ Tap and hold the shutter button
  - The set shutter speed is displayed in orange, the automatically calculated exposure value in white.
- ▶ Shutter release

## APERTURE PRIORITY - A

Aperture priority mode sets the exposure automatically according to the manually selected aperture. This mode is suitable for pictures in which the depth of field is a critical compositional element.

By selecting an appropriately low aperture value, you can reduce the depth of field range, for example to make a face “stand out” in sharp focus against an unimportant or distracting background. Conversely, you can use a higher aperture value to increase the depth of field range, so that everything from the foreground to the background will be in full focus in a landscape shot.

- ▶ Select the operating mode **A** (see p. 75)
- ▶ Select the desired aperture value via the right setting wheel
  - The set aperture value is displayed in orange, the automatically calculated shutter speed in white.
- ▶ Tap and hold the shutter button
- ▶ Shutter release

## Notes

- The remaining exposure time after shutter release is counted down in seconds on the display for shutter speeds greater than 2 s.
- Image noise becomes apparent when using higher sensitivities, particularly on uniform dark areas. In order to reduce this annoying phenomenon, the camera will take a second “black picture” (taken with the shutter closed) automatically after pictures taken with slow shutter speeds and high ISO values. The noise metered in this parallel picture is then digitally “subtracted” from the data for the actual picture. Where that is the case, the message **Noise reduction 12s** (time example) will appear on the LCD panel. The doubling of the “exposure” time must be taken into account for long exposure times. The camera must not be switched off during that time.

## MANUAL EXPOSURE SETTING – M

The following manual settings for shutter speed and aperture are a good choice:

- to create a special image mood that can only be achieved with a very specific type of exposure
  - to ensure a perfectly identical exposure for multiple images with different cropped sections
- ▶ Select the operating mode **M** (see p. 75)
  - ▶ Tap the shutter button
    - The values for shutter speed and aperture are displayed in white.
    - The light balance scale is additionally displayed. It covers a range of  $\pm 3$  EV (exposure value) in 1/3 EV increments. Settings within  $\pm 3$  EV are indicated by white lines on the scale, settings outside this range by red lines.
    - The exposure compensation is done using the scale of the light balance:
      - No white scale lines = correct exposure
      - White scale lines to the left/right of the center mark = under or overexposure by the displayed value or by more than  $\pm 3$  EV (Exposure Value)
  - ▶ Select the desired aperture value via the right setting wheel
  - ▶ Select the desired shutter speed value via the left setting wheel
  - ▶ Shutter release

### Note

The screen image will show an exposure simulation if **P-A-S-M** is selected in the menu item **Exposure Preview**.

## EXPOSURE CONTROL

### (FUNCTIONS FOR AUTOMATIC EXPOSURE)

#### EXPOSURE SIMULATION

With factory settings in place, the brightness of the screen image in the three automatic exposure modes **P**, **S** and **A** matches the relevant exposure settings<sup>1</sup>.

You can now assess and control the effect of the relevant exposure setting on the image before taking the picture.

This function is also available for the manual exposure setting **M**:

- ▶ Select **Exposure Preview** in the main menu
- ▶ Select **P-A-S** (only in automatic, aperture priority and shutter speed priority mode) or **P-A-S-M** (also for manual setting)

#### Notes

- Depending on ambient lighting conditions, the brightness of the screen image may differ from that of the actual pictures, despite the settings described above. The screen image will appear considerably darker than the – correctly exposed – picture. That is particularly the case in long-term exposures.

<sup>1</sup> This will apply as long as the subject brightness and the set exposure don't result in excessively low or high brightness values.

## METERING MEMORY LOCK

We often want to arrange important subject elements outside the center of the picture for reasons of picture composition and these elements may sometimes be very bright or very dark. Center-weighted metering and spot metering, however, mainly capture an area in the center of the image and are calibrated to an average gray scale value. In that case, the metering memory lock function – in **P**, **S** and **A** exposure modes, and the AF modes Spot/Field metering – initially allows a metering of the main object and to store the relevant settings until the final image section is set. With the factory settings in place, both lock functions are done via the shutter button. The metering memory lock functions can also be divided up between the shutter button, the **FN** button or the right setting wheel button. Alternatively, both functions can be assigned to the **FN FN** button or the right setting wheel button.

## AE-L (Auto Exposure Lock)

The camera stores the exposure value. The focus can therefore be set on another object, no matter which exposure value is selected.

## AF-L (Auto Focus Lock)

The camera stores the focus setting. That makes it easier to change the image section when focusing is fixed.

## AF-L + AE-L

With this option enabled, the camera stores the exposure value and the focus setting when the assigned button is pressed and held.

Menu settings	Tap the shutter button	FN Button/ Right setting wheel button
AF-L + AE-L*	no function	Exposure and focus
AF-L*	Exposure	Sharpness
AE-L*	Sharpness	Exposure

\* The functions include settings and storage

### Via the shutter button

- ▶ Aim at the key subject element (using the metering field for spot metering) or alternatively at another detail with average brightness.
- ▶ Tap and hold the shutter button
  - The measurement is taken and saved.
- ▶ Shutter release

### **Note**

The metering memory lock is canceled when you release the shutter button.

### Via the FN button/right setting wheel button

- ▶ Select **Customize Control** in the main menu
- ▶ Select **FN button/Right setting wheel button** in the submenu
- ▶ Select the desired setting  
(**AF-L + AE-L**, **AE-L**, **AF-L**)
- ▶ Aim at the object
- ▶ Press the **FN** button/right setting wheel button
  - The measurement is taken and saved.
  - A small padlock icon with the letters AE appear at the bottom left of the screen to signify that the exposure value was saved.
  - A green AF metering field signifies that the focusing was saved.
  - The exposure value/focusing remain until the same button is pressed again.
- ▶ Select the final image section
- ▶ Shutter release

### **Notes**

- Only one of the two metering memory locks (**AF-L** or **AE-L**), or both at the same time (with **AF-L + AE-L**) can be set for a recording.
- The assigned button must be pressed again to remove the memory lock and to take a new measurement.
- The shutter button will retain both functions, as long as no metering memory lock is done via the **FN** button/right setting wheel button.
- A metering memory lock doesn't make much sense in conjunction with multi-field metering, because a targeted capture of an individual object element will not be possible.
- A change in the aperture setting after the metering memory lock is set will not result in an adjustment of the shutter speed, i.e. the end result would be an incorrect exposure.

## EXPOSURE COMPENSATION

Exposure meters are calibrated for a medium gray scale value, which matches a standard, i.e. average image object. Should the measured image detail not fulfill that requirement, then the a relevant exposure compensation can be effected.

Specifically where several pictures are taken in sequence, for example if for a series a slightly lesser or greater exposure is desired for a particular reason, then exposure compensation can be a very useful function: Once set, the setting remains active – unlike the metering memory lock – until it is reset.

Exposure compensation can be set in the range  $\pm 3\text{EV}$  in  $1/3\text{EV}$  increments (EV: exposure value).

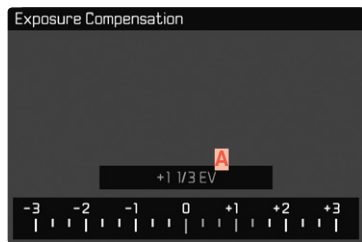

**A** Set compensation value (marks at 0 = Off)

- ▶ Select **Exposure Compensation** in the main menu
  - A scale appears as a submenu item.
- ▶ Set the value on the scale
  - The set value is displayed above the scale.
  - While setting the value, you can see the effect on the screen image, which becomes darker or lighter.

In modes **P, S, A, Sn P** and **A1**, a compensation value can also be set directly via one of the setting wheels.

### Notes

- When setting the exposure manually, exposure compensation can only be done via menu control, or if the function for direct access was selected (see p. 50).
- The following applies for set compensation values, no matter how they were initially set: They remain effective until they are manually reset to **0**, i.e. even if the camera is switched off and on again in the meantime.

## BRACKETING

Many attractive objects are rich in contrast, which means they have very bright and very dark areas. The image effect can be dramatically different, depending on which of these areas you choose to align your exposure with. The automatic bracketing function in aperture priority mode allows you to produce several alternatives with graduated exposure values and varying shutter speeds. You can then select the picture you like best or use relevant picture editing software to calculate an image with a particularly broad contrast spectrum (HDR).

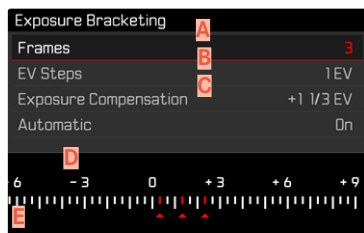

- A** Number of pictures
- B** Exposure difference between the pictures
- C** Exposure compensation setting
- D** Light value scale
- E** Exposure values of the images marked in red.  
(The scale will be offset by the relevant value if exposure compensation is set concurrently.)

3 graduations (1EV, 2EV, 3EV) and 3 or 5 pictures per series are available.

- ▶ Select **Picture Series** in the main menu
- ▶ Select **Exposure Bracketing** in the submenu
- ▶ Select the desired number of pictures under **Number of Frames** in the submenu
- ▶ Select the desired exposure offset under **EV Steps** in the submenu
- ▶ Select the desired **Exposure Compensation** value in the submenu
  - The marked exposure values change positions according to the settings selected. In the case of exposure compensation, the scale also shifts.
  - The selected exposure compensation value will be applied to the entire exposure series.
- ▶ Select the desired setting under **Automatic** in the submenu
  - With the factory setting in place (**Off**), the entire exposure series will run after the shutter button is pressed once; when the setting is **Off**, each picture must be taken individually.
- ▶ All pictures are taken by pressing the shutter button once or several times

## Notes

- Active bracketing is indicated by  on screen. You can watch the effect of the function on screen while the pictures are taken (brighter or darker).
- Depending on the exposure mode chosen, graduations are generated by changing the shutter speed (P/A/M) or the aperture value (S).
- The picture sequence: Underexposure/correct exposure/overexposure
- The working range for automatic bracketing may be limited depending on the available shutter speed/aperture combination.
- With automatic ISO sensitivity control enabled, the sensitivity calculated by the camera automatically for the raw picture will also be applied to all other pictures in a series, i.e. the ISO value will not change during bracketing. This may mean that the slowest shutter speed specified under **Min. Shutter Speed** is exceeded.
- The focus range for automatic bracketing may be limited (depending on the originally set shutter speed). The specified numbers of pictures will be taken regardless. Several pictures in a series may consequently be taken with the same exposure values.
- The function remains active until another function is selected in the **Drive Mode** submenu or the camera is switched off and on again. If no other function is selected, another series of pictures is taken each time the shutter button is pressed.

## OTHER FUNCTIONS

### AUXILIARY DISPLAYS

Four functions are available.

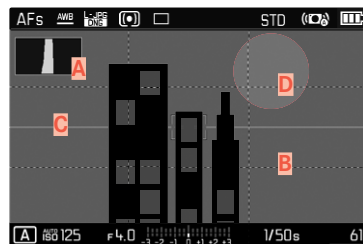

- A** Histogram
- B** Grid lines (**Grid Setup**)
- C** Horizon display (**Horizon**)
- D** Clipping

### Note

- The grid display will always appear when activated, i.e. independent of whether the information in the header and footer are accessed (see p. 56). With header and footer deactivated, the level display, histogram and clipping displays will not appear.



## HISTOGRAM

Histogram represents the brightness distribution in the picture. The horizontal axis shows the graduated values from black (left) through gray to white (right). The vertical axis corresponds to the number of pixels at each brightness level.

This type of rendering allows an additional quick and easy assessment of the exposure setting.



- ▶ Select **Capture Assistants** in the main menu
- ▶ Select **Histogram** in the submenu
- ▶ Select **On**

### Notes

- The histogram is always based on the brightness displayed; depending on the settings used, it may not represent the final exposure.
- In picture mode, the histogram should be regarded as a "trend indicator" and not as a depiction of the exact number of pixels.
- The histograms when reviewing and taking a picture may differ slightly from one another.
- The histogram function is not available for the simultaneous playback of multiple thumbnails or enlarged pictures.

## GRID LINES

The grid divides the image field into 3 x 3 equal fields.

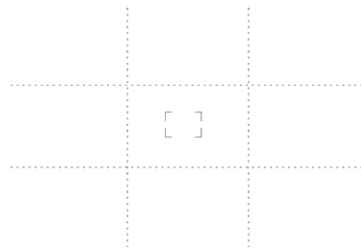

- ▶ Select **Capture Assistants** in the main menu
- ▶ Select **Grid Setup** in the submenu
- ▶ Select **On**

## HORIZON DISPLAY

The integrated sensors of the camera show its orientation. These indicators ensure exact camera orientation along the longitudinal and transverse axes of critical objects, e.g. architecture.

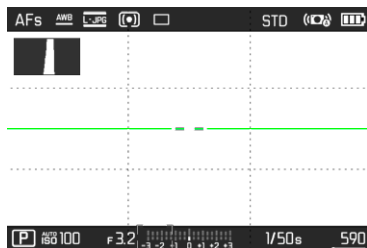

- ▶ Select **Capture Assistants** in the main menu
- ▶ Select **Horizon** in the submenu
- ▶ Select **On**

Two long lines to the left and right of the image center indicate the longitudinal axis on screen.

- in zero position = green
- in tilted position = red

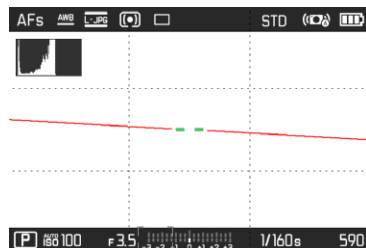

The transverse axis is indicated in level position by two green double-lines immediately left and right of the image center. When the camera is tilted, these lines are white and a short red line appears above or below them.

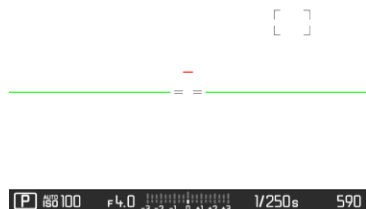

## CLIPPING

The Clipping display marks very bright image areas. This function is a very easy and exact tool for checking the correct exposure setting.

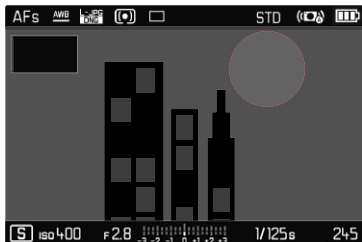

- ▶ Select **Capture Assistant** in the main menu
- ▶ Select **Clipping** in the submenu
- ▶ Select **On**

### Notes

- The clipping display is not available in video mode.

## SERIAL EXPOSURES

The camera is set to single shot exposures by default (**Single**). Serial exposures can also be created to e.g. capture motion sequences at various stages.

- ▶ Select **Picture Series** in the main menu
- ▶ Select the desired setting in the submenu  
(**Continuous Low Speed**, **Continuous Medium Speed**, **Continuous High Speed**)

Once you have finalized your settings, the camera will take serial exposures as long as you keep the shutter button pressed down fully (and you have sufficient space on your memory card).

## Notes

- We recommend deactivating the preview review mode (**Auto Playback/Review**) when using this function.
- The specified picture sequence stated in the technical information refers to a default setting (**ISO 200**, JPG format **L-JPG**). The picture sequence may differ in conjunction with other settings or depending on the picture content, **White Balance** setting and the memory card used.
- Regardless of how many pictures were taken in a series, the last picture in the series or the last picture saved on the memory card while the save process is ongoing will be displayed first in both review modes.
- Serial exposures with **Continuous High Speed** set are taken at a frequency of max. 10 fps<sup>1</sup>, provided shutter speeds of 1/60 s or faster are used.
- Serial exposures are not possible if a flash is used. Only a single picture will be taken if the flash function is activated.
- Serial exposures are not available in combination with the self-timer function.
- The exposure frequency will slow down after a series of max. 33 exposures (**ONG + JPG**). This slow-down is due to the time required to transfer the data from the buffer memory to the card.

<sup>1</sup> mechanical/electronic shutter

## INTERVAL SHOOTING

This camera allows you to capture motion sequences over extended periods of time automatically using the interval shooting function. You specify the number of pictures, the intervals between pictures, and the start time of the series.

The exposure and focus settings are no different from those for normal pictures, but you should remember that the lighting conditions may change during the course of the picture series.

### SPECIFYING THE NUMBER OF PICTURES

- ▶ Select **Drive Mode** in the main menu
- ▶ Select **Interval** in the submenu
- ▶ Select **Frames**
- ▶ Enter the desired value

### SPECIFYING THE INTERVALS BETWEEN SHOTS

- ▶ Select **Drive Mode** in the main menu
- ▶ Select **Interval** in the submenu
- ▶ Select **Interval**
- ▶ Enter the desired value

### SETTING THE DELAY TIME

- ▶ Select **Drive Mode** in the main menu
- ▶ Select **Interval** in the submenu
- ▶ Select **Countdown**
- ▶ Enter the desired value

## To get started

- ▶ Press the shutter button
  - The time until the first picture and the number of pictures to be taken are shown in the upper right corner of the screen image.
  - The LCD panel will switch off automatically between recordings. Tapping the shutter button reactivates the LCD panel.
  - The remaining number of pictures will be displayed briefly between the pictures and a relevant message will appear, once the series is complete.

## To cancel a running serial exposure

- ▶ Switch off the camera

## Notes

- The camera may switch off and on again if "Auto power off" is set and no other camera operation occurs between the individual shots.
- Interval shooting over an extended period of time in a cold location or in a place with high temperature and humidity may result in malfunctions.
- Interval shooting will be interrupted or canceled in the following situations:
  - if the battery is depleted
  - if the camera is switched off

Make sure to check the battery for sufficient charge.

- Interrupted or canceled interval shooting can be resumed by switching the camera off, replacing the battery or memory card as needed and then switching the camera back on. A prompt will be displayed on screen if the camera is switched off and on again while the **Interval** shooting function is active.

- The interval function remains active after a picture series is completed, and also after the camera is switched off and on again, until another exposure mode (picture series) is set.
- The availability of this function does not mean that the camera is suitable for use as a monitoring device.
- Regardless of how many pictures were taken in a series, the last picture in the series or the last picture in the series or the last picture saved on the memory card while the saving process is ongoing will be displayed first in both review modes.
- The pictures of an interval shoot are marked with  in playback mode.
- The camera may under some circumstances be unable to take good pictures. That may happen if, for example, focusing was unsuccessful. In that case, the camera will not take a picture and the series will continue with the next interval. The message **Some frames were dropped** appears on screen.

## SELF-TIMER

The self-timer function allows taking pictures with a preset time delay. We recommend that the camera is placed on a tripod.

- ▶ Select **Self-timer** in the main menu
- ▶ Select **Self-timer 2 s**/**Self-timer 12 s** in the submenu
- ▶ Shutter release
  - The remaining time until exposure is counted down on screen. The self-timer LED at the front of the camera counts down the delay time. It flashes slowly during the first 10 s, then fast for the last 2 s.
  - The self-timer delay time can be canceled at any time by tapping the shutter button; the relevant settings remain intact.

### Notes

- The self-timer function remains active until it is deactivated via the menu or the camera is switched off.
- The self-timer function is only available for individual recordings.

## ELECTRONIC SHUTTER

The Leica CL comes equipped with a mechanical shutter and a purely electronic shutter function. The electronic shutter expands the available shutter area and functions completely noiseless, which may be important in some work environments.

- ▶ Select **Electronic Shutter** in the main menu
- ▶ Select the desired setting in the submenu

<b>Off</b>	Only the mechanical shutter is used. Working range: 30 s to 1/8000 s.
<b>Always On</b>	Only the electronic shutter function is used. Working range: 1 s to 1/25000 s.
<b>Extended</b>	You can add in the electronic shutter functions if you need faster shutter speeds than can be achieved with the mechanical shutter. Working range: 30 s to 1/25000 s.

## FLASH PHOTOGRAPHY

The camera determines the necessary flash intensity by firing one or more pre-flashes before taking the actual picture. The main flash fires immediately after, i.e. during exposure

### COMPATIBLE FLASH UNITS

The following flash units offer a TTL flash metering function and – depending on the model – a varying number of the functions described in this manual:

- The Leica system flash units SF 40, SF 58 and SF 64
- Other Leica system flash units, except Leica SF 20
- Other commercially available flash units with a standard flash foot and positive center contact<sup>1</sup> (fired via the center/X contact).
- Studio flash units (fired via synchronization cable)

We recommend using state-of-the-art thyristor-controlled electronic flash units.

## ATTACHING THE FLASH UNIT

- ▶ Switch off the camera and flash unit
- ▶ Pull off the accessory shoe cover and store it in a safe place
- ▶ Slide the foot of the flash unit all the way into the accessory shoe and use the clamping nut (where available) to secure it against accidental movement
  - Movement inside the accessory shoe can interrupt required contacts and therefore cause malfunctions.

The display for the set flash mode appears in white (see next pages). The flash mode will blink red if the flash unit is not fully charged and therefore not ready.

## DETACHING THE FLASH UNIT

- ▶ Switch off the camera and flash unit
- ▶ Detaching the flash unit
- ▶ Replace the accessory shoe cover

### Note

- The accessory shoe cover should always be attached when no accessory is used.

<sup>1</sup>Activate the **fwb** Flash setting if you will be using flash units that are not directly compatible with the camera and will therefore not automatically adjust the white balance of the camera.

## FLASH EXPOSURE METERING (TTL METERING)

The camera offers a fully automated, camera-controlled flash mode in conjunction with system-compatible flash units (see p. 95) and for the auto modes aperture priority and manual setting.

In aperture priority mode and with manual setting, the camera also allows the use of additional flash techniques like flash synchronization and firing with slower shutter speeds than the sync time 1/250 s, which may be interesting in terms of picture composition. These functions are set on the camera via the menu (please read the relevant next sections for more information).

The camera additionally communicates the sensitivity setting to the flash unit. The flash unit can use this information to automatically adjust its range data, provided the device comes with these displays and the aperture setting selected on the lens is also entered manually on the flash unit. The ISO sensitivity setting cannot be altered via the flash unit on system-compatible units, because the information is received from the camera.

## SETTINGS ON THE FLASH UNIT

Operating mode	
<b>TTL</b>	Automatic camera control
<b>A</b>	Aperture priority
<b>M</b>	The flash exposure must be set to an output level to match the aperture and shutter speed settings determined by the camera.

Set the flash unit to **TTL** mode to allow automatic control of the unit by the camera.

When set to **A**, subjects with above or below average brightness may not be exposed correctly.

In **M** mode, the flash exposure must be set to an output level to match the aperture and shutter speed settings determined by the camera by setting an appropriate partial light power level.

### Note

Please read the relevant instructions provided with third party flash units regarding their various operating modes.



## FLASH MODES

Select one of the three available operating modes.

- Automatic
- Manual
- Long-term exposure

Factory setting: **Auto**

### **A** AUTOMATIC FLASH ACTIVATION

That is the default flash mode. The flash unit will fire automatically if poor lighting conditions would mean slower shutter speeds, which could result in blurred images.

### **MANUAL FLASH ACTIVATION**

This mode is suitable for backlit pictures in which the main subject does not fill the entire frame and is in shadow, or in situations where a fill-in flash will moderate sharp contrasts (e.g. in direct sunlight). The flash will fire each time a picture is taken, regardless of prevailing lighting conditions. The flash intensity depends on the metered ambient brightness: in poor light it is the same output as in automatic mode, with output decreasing with increasing brightness. The flash will then work as a fill-in light, e.g. to light up dark shadows in the foreground or backlit objects, and to create more balanced overall lighting.

### **S** AUTOMATIC FLASH ACTIVATION AT SLOWER SHUTTER SPEEDS (LONG-TERM SYNCHRONIZATION)

This mode ensures appropriately exposed, brighter dark backgrounds and bright foreground.

The shutter speed is not extended beyond 1/30 s in the other flash modes to minimize the risk of blurring. This may mean, however, that pictures with flash exposure can end up with objects in the background not illuminated by the flash and therefore being underexposed. In this mode, slower shutter speeds (up to 30 s) are permitted to avoid this effect.

## FLASH CONTROL

The settings and functions described in the following sections only apply to settings and functions available in this camera and in system-compatible flash units.

### SYNC POINT

Flash exposures are lit by two light sources:

- Ambient light
- Flash

Any subject elements lit primarily by the flash will almost always be rendered in perfect focus by the short burst of light, provided the focus is set correctly. All other subject elements in the same frame lit by ambient light or lit from within will be rendered with varying degrees of sharpness. Whether or not these object elements will be rendered in sharp focus or blurred, as well as the degree of "blurriness" depends on two interdependent factors:

- the shutter speeds
- The speed of movement of the subject elements or camera during recording

The longer the shutter speed and the faster the motion, the greater the difference between the two superimposed partial images.

A flash is usually fired at the start of exposure (**Start of Exp.**), right after the first shutter curtain has completely opened the image window. This may result in apparent contradictions, e.g. the picture of a vehicle being overtaken by its own light trail. This camera allows you to synchronize the flash firing with the end of exposure (**End of Exp.**), right before the second shutter curtain closes the image window. The sharp image will in this case be a rendering of the end of the captured motion. This flash technique creates a more natural impression of movement and dynamics in the image. This function is available with all camera and flash unit settings.

- ▶ Select **Flash Settings** in the main menu
- ▶ Select **Flash firing point** in the submenu
- ▶ Select a setting  
(**Start of Exp.**, **End of Exp.**)

### Note

When using the flash with faster shutter speeds, a difference between the two flash times will be barely discernible or only noticeable for very fast movements.

## FLASH RANGE

The usable flash range depends on the aperture and sensitivity values set manually or calculated by the camera. It is important to ensure that the subject is within the relevant flash range for sufficient illumination. A permanent setting to the shortest available shutter speed for flash mode (sync time) may often result in unnecessary underexposure of those subject elements that are not lit sufficiently by the flash.

This camera allows the fine tuning of the shutter speed used in flash mode in combination with aperture priority depending on the conditions of the object or your own picture composition ideas.

## FLASH EXPOSURE COMPENSATION

This function can be used to selectively reduce or enhance flash exposure regardless of ambient light, e.g. to brighten the face of a person in the foreground when taking a picture outdoors in the evening while retaining the same general lighting mood.

- ▶ Select **Flash Settings** in the main menu
- ▶ Select **Flash Exposure Compensation** in the submenu
  - The submenu displays a scale with a red setting mark. The function is deactivated if the value is set to 0.
- ▶ Set the desired value
  - The configured compensation is displayed as **±X EV**<sup>1</sup> above the scale.

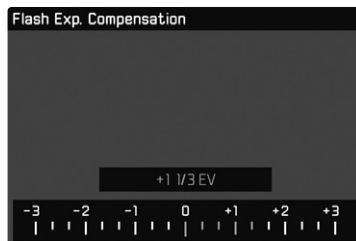

<sup>1</sup> Example (Plus or Minus): **±X EV** stands for the relevant value.

## Notes

- Flash exposure compensation changes the range of the flash unit.
- Once set, the compensation value remains active until it is reset to 0, no matter how many pictures are taken or if the camera is switched off.
- A compensation value configured on the camera will be overruled when a relevantly equipped flash unit is attached, e.g. a Leica SF 60 and a compensation value is entered on that flash unit.
- The menu item **Flash Exposure Compensation** can only be used in conjunction with flash units on which the compensation value cannot be set manually (e.g. Leica SF 26). The settings on the scale in the camera menu can therefore only be confirmed if a suitable flash unit is connected and switched on.
- A brighter flash illumination with Plus compensation will require a greater flash intensity. Flash exposure compensation will therefore impact on the flash range: A Plus correction will decrease it, a Minus correction will increase it.
- An exposure compensation set on the camera will only affect the measurement of ambient light. If a simultaneous TTL flash exposure metering compensation is desired in flash mode, then it must be additionally set on the flash unit. (Exception: On the Leica SF 26, the compensation value must be set on the camera via menu control.)

## FLASH PHOTOGRAPHY

- ▶ Switch on the flash unit
- ▶ Set the desired guide number control mode (e.g. TTL or GNC = Guide Number Control) on the flash unit
- ▶ Switching the camera on
- ▶ Tap the shutter button before each flash exposure to activate exposure metering
  - The flash unit may not fire if this step is missed by pressing the shutter button down completely and skipping these settings.
- ▶ Set the desired exposure mode, shutter speed and/or aperture setting
  - It is imperative to take note of the shortest flash sync speed, as it determines whether a "normal" flash or an HSS flash is fired.
- ▶ Select **Flash Settings** in the main menu
- ▶ Select **Flash Mode** in the submenu
- ▶ Select a setting
  - The currently active mode is displayed on screen.



## Notes

- A flash unit that is not ready to flash may cause incorrect exposures or error messages.
- Studio flash systems may have a very long flash firing duration. It may therefore be advantageous to select a slower shutter speed than 1/180 s when using such a system. The same applies for RF-controlled flash firing for so-called "off-camera" flashes, as the transmission time may cause a delay.
- Serial exposures and automatic bracketing with flash are not available. With the camera set to one of these modes, there will be no flash display on screen even if the flash unit is attached and the flash will not fire.
- The  setting (long-term synchronization) is unavailable and grayed out if a flash unit is attached that is not system compatible.
- Use a tripod to prevent blurring at slow shutter speeds. Alternatively, you can select a higher sensitivity.
- A flash unit and the Leica Visoflex electronic viewfinder cannot be used simultaneously.

## VIDEO MODE

### START/EXIT VIDEO MODE

This camera is equipped to take pictures and record video.

You can choose one of two video recording modes:

- **PI**: Exposure compensation can be set manually.
- **AI**: Exposure compensation and aperture setting can be set manually.

All other exposure settings are done automatically.

The setting for exposure compensation (**PI/AI**) and aperture (**AI** only) is done via the setting wheels (see p. 39).

#### Notes

- As only part of the sensor area is used in video recordings, the relevantly effective focal length is increased, which slightly reduces the size of the image sections.
- You can record up to 29 minutes of uninterrupted video.
- The max. file size for uninterrupted video recording is 96 GB. Once a recording exceeds this file size, the overrun will be automatically stored in a new file (but cannot be longer than 29 min).
- Some menu items are unavailable in Video mode. The text in the relevant line is displayed in gray to signify the existence of a submenu.
- Only the histogram display is available for video recordings.

There are two methods for toggling between Picture and Video mode:

#### Using touch control

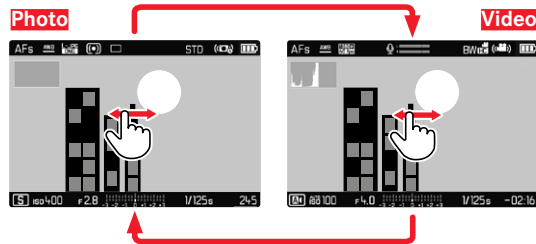

- The camera switches to the most recently set photo or video mode.

#### Using button control

- ▶ Press the left setting wheel button
  - The currently selected mode is shown in the top display.
- ▶ Turn the left setting wheel to select the desired mode (**PI** or **AI**)
  - The mode display changes in the top display and on screen.
  - All modes can be reached by turning the wheel in either direction.
  - The selected mode will be applied automatically approx. 2 s after the setting wheel is moved the last time.

#### To apply the selected mode immediately

- ▶ Press the left setting wheel button or the shutter button

## START/END VIDEO RECORDING

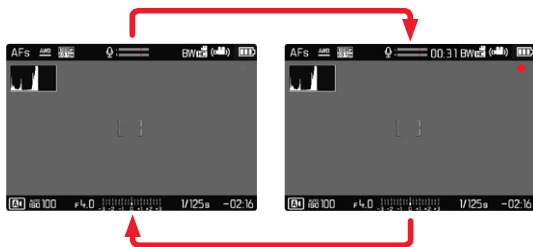

- ▶ Press the shutter button
  - Video recording begins.
  - The dot flashes red.
  - The Status LED flashes.
  - Recording time is running.
- ▶ Press the shutter button again
  - Video recording ends.
  - The dot lights in gray.

### Notes

- Basic recording settings (see p. 58) must be configured before recording.
- No direct access to menu functions is possible during video recording.
- Automatic exposure control takes into account any fluctuations in brightness. Set the shutter time manually if this is undesirable, e.g. for landscape recordings or panning.

## EXPOSURE CONTROL

Exposure control for video recording is completely independent of the exposure mode or the shutter speed and aperture settings for photos.

	<b>P</b>	<b>A</b>
Aperture	Automatic	Manual
Shutter speed	Automatic (max. shutter speed limited by Video resolution)	
ISO	Automatic ISO 100 to ISO 3200	
Exposure compensation	Manual	

## FOCUSING

Focusing can be done during operation, depending on the selected focus mode:

- by tapping and holding the shutter button (AF)
- by turning the focus ring (MF)

## PLAYBACK/REVIEW MODE

There are two completely independent playback/review functions available:

- short-term rendering directly after exposure (Preview)
- normal Review mode, in which the stored recordings can be viewed and managed for any length of time

The switchover between recording and playback/review mode, as well as most other actions can be completed using gesture or key control. Please see p. 40 for more information about the available gestures.

## INITIATE/EXIT PLAYBACK/REVIEW MODE

Using touch control

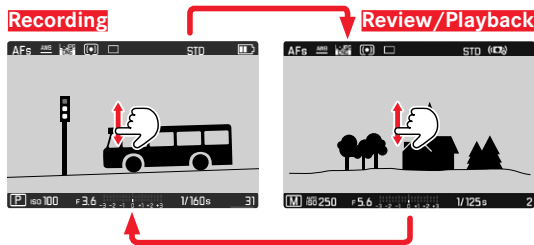

Using button control

- ▶ Press the **PLAY** button
  - The last picture taken appears on the screen.
  - The following message appears if the inserted memory card does not contain any picture data: **No valid image to display**
  - The **PLAY** button function differs, depending on the current camera setting:

Initial situation	After pressing the PLAY button
Full screen display of a recording	Recording mode
Display of an enlarged cropped section/or several thumbnails	Full screen display of the recording



## SELECTING/SCROLLING THROUGH RECORDINGS

The recordings are visually arranged in a horizontal reel. When the end of an image series is reached, the display automatically jumps back to the first image in the series. All recordings can therefore be reached by scrolling either right or left.

### Using touch control

- ▶ Swipe to the left or right

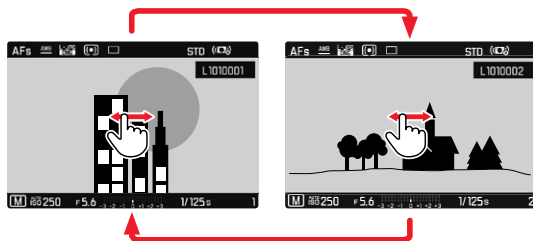

### Using button control

- ▶ Turn the left setting wheel or press the directional pad right/left

## DISPLAYS IN PLAYBACK/REVIEW MODE

With the factory settings in place, recorded pictures will be displayed without the information in the header and footer lines for an unobstructed view of the image. The configured displays can be accessed at any time.

- ▶ Press the center button
  - The displays for **Histogram** and **Clipping** will appear if these functions are activated.



Video recordings are always rendered with header and footer and with **PLAY** ▶.



## Notes

- Recorded pictures are not automatically rotated in Review mode to utilize the full screen area.
- It may not be possible to render files with this camera that were not recorded with this device.
- In some cases, the screen image may not have the expected quality or the LCD panel will remain blank and only display the file name.
- The histogram and clipping displays are available only when viewing the full size picture, but not during zooming or in the overview.
- You can toggle back from playback mode to recording mode at any time by tapping the shutter button.

## DISPLAYING ASSIST FUNCTIONS

The display of histogram and clipping in playback/review mode can be set separately from the relevant settings for the recording mode.

- ▶ Select **Playback/Review Mode Setup** in the main menu
- ▶ Select **Histogram/Clipping** in the submenu
- ▶ Select **On** or **Off**.

### Note

- The clipping display is not available in video mode.

## CROPPED SECTION ZOOM

You can zoom in to any section of an image for closer inspection. Zooming via the right setting wheel is done in four increments; zooming is stepless via touch control.

### Using touch control

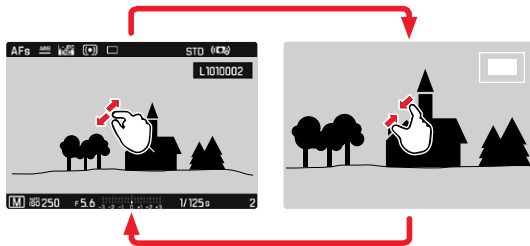

- ▶ Two-finger pinch/spread
  - The central cropped section of the picture is enlarged.

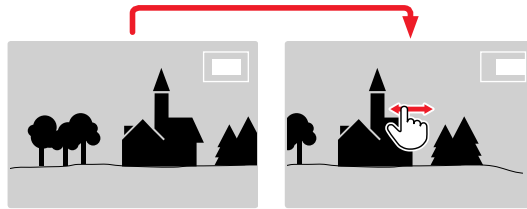

- ▶ Swiping will allow you to move the position of an enlarged cropped section
  - The rectangle within the frame in the top right corner represents the currently magnified section, as well as its position in the image.



- ▶ Double tap
  - Toggles between the third zoom increment at the tap position and standard full screen view.

Using button control

- ▶ Turn the right setting wheel  
(to the right: increase magnification, to the left: decrease magnification)
- ▶ Press the right setting wheel button
  - Toggles between the third zoom increment and standard full screen view.
- ▶ Press the directional pad to move the cropped section anywhere in the enlarged image
  - The rectangle within the frame in the top right corner represents the currently magnified section, as well as its position in the image.

You can move directly from one picture to the next in magnification mode, which will then also be displayed with the same magnification.

- ▶ Turn the left setting wheel to the left/right

To display the recording in full size

- ▶ Press the right setting wheel button, the center button or the **PLAY** button

**Notes**

- It may not be possible to enlarge pictures taken with other camera types.
- Video recordings cannot be enlarged.

**DISPLAYING MULTIPLE RECORDINGS AT ONCE**

The camera offers an overview function in which several thumbnail images can be viewed on one screen, which makes it easier to find a specific image. You can choose 12 or 30 images per overview.

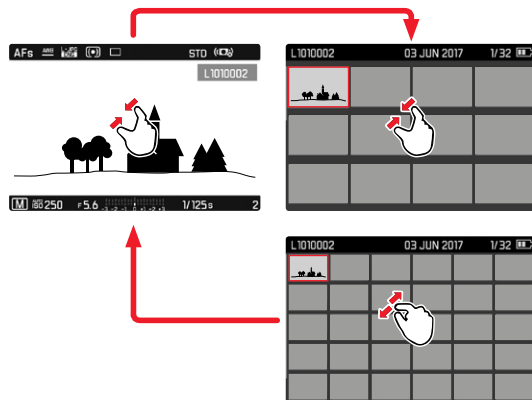
Using touch control

- ▶ Two-finger pinch
  - The display toggles from 12 to 30 thumbnails.

To view other recordings

- ▶ Swipe up or down

## Using button control

- ▶ Turn the right setting wheel to the left
  - 12 thumbnails are shown at the same time. Another turn on the thumbwheel increases the number of displayed recordings to 30.

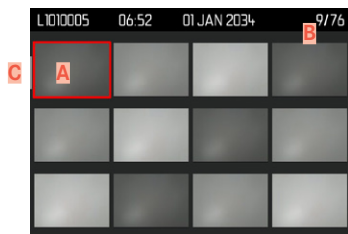

- A** Currently selected recording
- B** Number of the currently selected recording
- C** Scrollbar

The currently viewed recording is framed in red and can be selected for a closer look.

## To navigate between recordings

- ▶ Press the directional pad left or right as needed  
or
- ▶ Turn the left setting wheel

## To display the recording in full size

### Using touch control

- ▶ Two-finger spread  
or
- ▶ Briefly touch the image

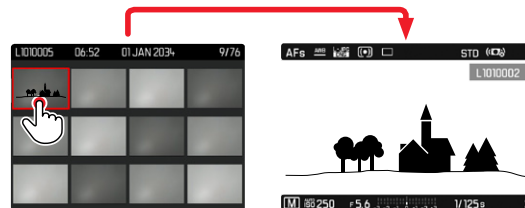

### Using button control

- ▶ Turn the right setting wheel to the right  
or
- ▶ Press the right setting wheel button, the center button or the **PLAY** button

## TAGGING/RATING OF RECORDINGS

Recordings can be tagged as favorites to find them quicker or to simplify the later deletion of multiple recordings. Tagging can be done in regular view mode or in the overviews.

### Tagging a recording

- ▶ Press the left setting wheel button
  - The recording is marked with . The icon will appear in the header line on the far right when viewing images in full size, and in the top left corner of the thumbnail in overview mode.

### Removing a tag

- ▶ Press the left setting wheel button
  - The  marking disappears.

## DELETING RECORDINGS

There are several methods available to delete recordings:

- Deleting individual recordings
- Deleting multiple recordings
- Deleting all recordings without a tag/ranking
- Deleting all recordings

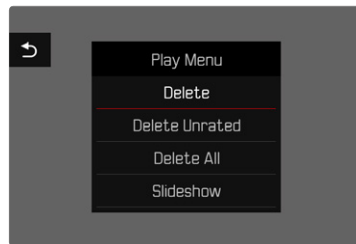

### Important note

Once deleted, recordings are no longer retrievable.

## DELETING INDIVIDUAL RECORDINGS

- ▶ Press the **MENU** button
- ▶ Select **Delete** in the Playback/Review menu

or

- ▶ Press the **FN** button
  - The Delete screen appears.



- ▶ Select the Delete icon  (tap the icon briefly or press the center button)
  - The LED will flash during the delete process. The process may take a few seconds.
  - The next recording will be displayed once deletion is complete. The following message appears if no other recordings are saved on the card: **No valid image to display**.

To cancel deletion and return to the normal Playback/Review mode

- ▶ Press the **PLAY** button
- or
- ▶ Tap the "Go back" icon  briefly

### Notes

- The Delete screen can be called up only by pressing the **FN** button when in overview mode, because the menu function **Delete** of the Review menu is not available in this context.
- The "Scroll" and "Magnify" functions continue to be available when the "Delete" screen is active.

## DELETING MULTIPLE RECORDINGS

Several recordings can be marked in a Delete overview with twelve thumbnails and can then be deleted all at once. This overview can be reached in two ways.

- ▶ Turn the right setting wheel to the left
  - The overview screen appears.
- ▶ Press the **MENU** button
- ▶ Select **Delete Multi** in the Review menu
  - The Delete overview appears.

or

- ▶ Press the **FN** button
  - The Delete screen appears.
- ▶ Turn the right setting wheel to the left
  - The Delete overview appears.



Any number of recordings can be selected in this view.

- ▶ Select a recording using the directional pad.
  - ▶ Press the center button/right setting wheel button
- or
- ▶ Briefly touch the image
    - The recordings selected for deletion are marked with a red Delete icon .

### To delete the selected recordings

- ▶ Press the **FN** button
- or
- ▶ Tap the Delete icon  briefly
    - The prompt **Delete all marked files?** appears.
  - ▶ Select **Yes**

### To cancel deletion and return to the normal Playback/Review mode

- ▶ Press the **PLAY** button
- or
- ▶ Tap the "Go back" icon  briefly



## DELETING ALL RECORDINGS

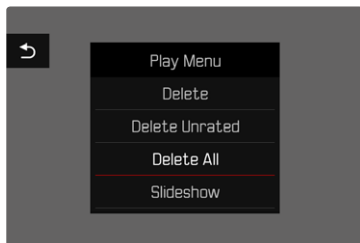

- ▶ Press the **MENU** button
- ▶ Select **Delete all** in the Review menu
  - The prompt **Delete all files?** appears.

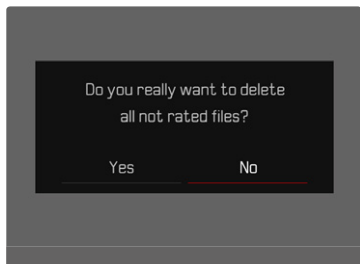

- ▶ Select **Yes**

### Note

The message **No valid picture to play** appears after successful deletion. The same picture is displayed again if deletion was unsuccessful. When deleting several or all pictures/recordings, a notification screen may appear for the time needed to process the data.

## DELETING UNRATED RECORDINGS

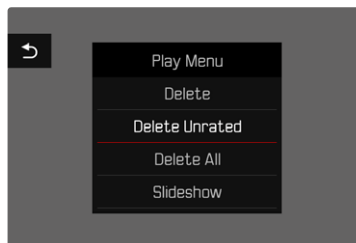

- ▶ Press the **MENU** button
- ▶ Select **Delete unrated** in the Review menu
  - The prompt **Do you really want to delete all unrated images?** appears.
- ▶ Select **Yes**

### Note

The LED will flash during the deletion process. The next marked recording appears once deletion is complete. The message **No valid picture to play** appears if no other recordings are saved on the card.

## PREVIEW OF LATEST RECORDING

Photo and video recordings can be displayed automatically directly after they are taken to e.g. check the success of the recording quickly and easily. A duration for the automatic display can be configured.

- ▶ Select **Auto Review** in the main menu
- ▶ Select the desired function and/or duration in the submenu (**Off**, **1 s**, **3 s**, **5 s**, **Permanent**)

**Permanent**: The most recent recording is displayed until automatic review is ended by pressing the **PLAY** button or by tapping the shutter button.

As long as you keep the shutter button pressed down completely after the photo/video was taken, the most recent images will be played back, even if **Off**, **1 s**, **3 s**, or **5 s** is set.

## Notes

- All buttons except the **FN** button, the menu button and the right setting wheel button change to the regular Review mode and execute their normal functions there for the duration of the automatic review. The camera will remain in Review mode until it is exited.
- Tagging and deleting can only be done in regular Review mode and not during automatic review.
- When pictures were taken with the functions Serial exposures or Interval shooting, then the last image in the series will be displayed or – if the save process is still incomplete – the last image in the series saved to the memory card.
- Where display times were configured (**1 s**, **3 s**, **5 s**) automatic review can be ended immediately by pressing the **PLAY** button or tapping the shutter button.

## SLIDE SHOW

A slide show function is available in Review mode, in which the saved images are shown automatically in series. The user can choose to see all recordings (**Show all**), only photos (**Pictures only**) or only videos (**Videos only**) and how long these recordings should be displayed (**Duration**).

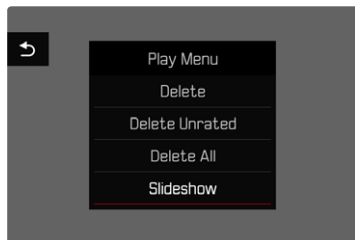

- ▶ Press the **MENU** button
- ▶ Select **Slideshow** in the Review menu

## SETTING THE DURATION

- ▶ Press the **MENU** button
- ▶ Select **Duration** in the Review menu
- ▶ Select the desired duration (**1 s**, **2 s**, **3 s**, **5 s**)

## STARTING THE SLIDE SHOW

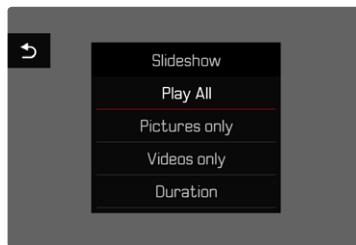

- ▶ Select the desired setting (**Play All**, **Pictures only**, **Videos only**)
  - The slide show will start automatically with the selected recordings and runs in an endless loop until it is exited.

## ENDING THE SLIDE SHOW

- ▶ Press the **PLAY** button
- or
- ▶ Tap the shutter button
  - The camera switches to the relevant mode.

### Notes

- An intermediate screen may appear while the data is prepared for playback.
- The settings in **Duration** remain intact even after the camera is switched off and on again.

## VIDEO PLAYBACK

**PLAY** ▶ appears on screen if you have selected a video file in playback mode.

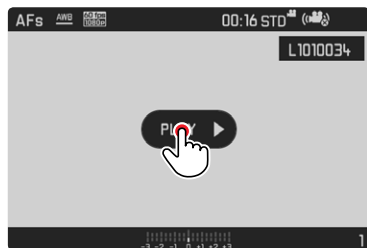

### START PLAYBACK

- ▶ Press the center button
- or
- ▶ Touch **PLAY** ▶ briefly

## ACCESSING THE CONTROL ELEMENTS

The control elements are displayed when playback is stopped.

### Using touch control

- ▶ Briefly tap the LCD panel

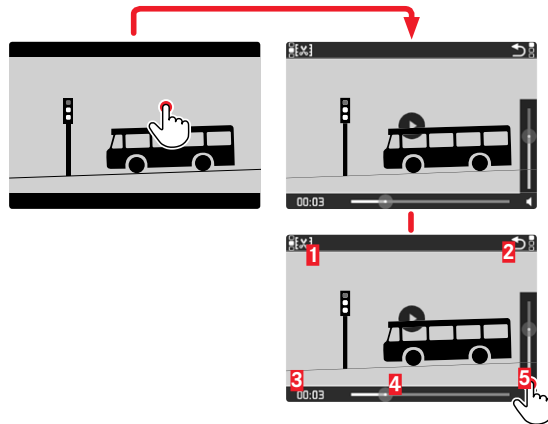

- 1** Video editing function
- 2** Exit video playback
- 3** Playback status bar
- 4** Elapsed playback time
- 5** Playback volume

### Using button control

- ▶ Press the center button

#### **Note**

The control elements disappear after about 3 s. Touching the LCD panel or pressing the center button will cause them to be displayed again.

### **PAUSE PLAYBACK**

- ▶ Touch the LCD panel briefly (anywhere)
- or
- ▶ Press the center button

### **RESUMING PLAYBACK/REVIEW**

While the control elements are visible:

### Using touch control

- ▶ Touch the LCD panel briefly anywhere in the picture

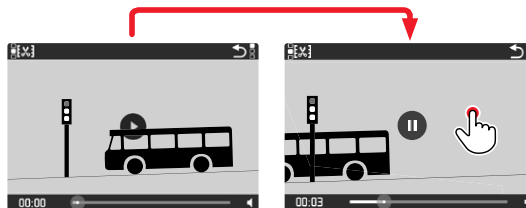

### Using button control

- ▶ Press the center button

## CONTINUE PLAYBACK FROM ANY POINT IN THE FILE

While the control elements are visible:

- ▶ Touch the playback status bar briefly at the desired position

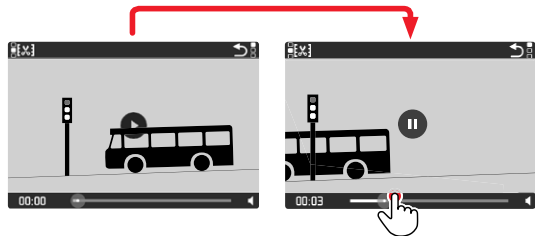

## END PLAYBACK

Using touch control

When control elements are visible:

- ▶ Tap the "Go back" icon ↶ briefly

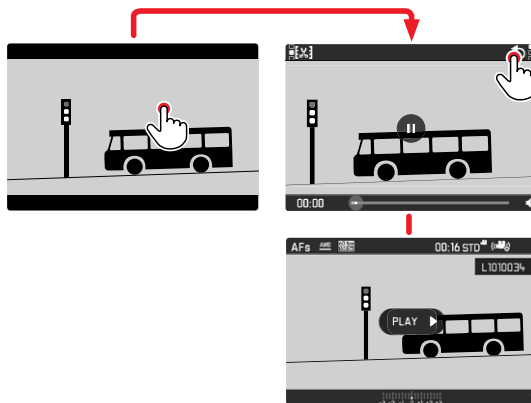

Using button control

- ▶ Press the **PLAY** button

## SETTING THE VOLUME

### Using touch control

When control elements are visible:

- ▶ Tap the volume icon briefly
- ▶ Touch the volume status bar briefly at the desired position

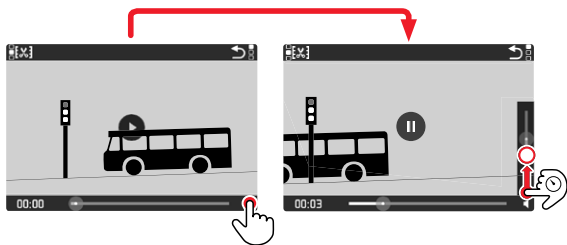

### Using button control

- ▶ Press the directional pad up/down
  - The volume status bar appears.
- ▶ Press the directional pad up (louder) or down (quieter)

### Note

Sound is switched off at the lowest part of the bar and the volume icon changes to .

## VIDEO EDITING

### Using touch control

- ▶ Access the video editing function (tap the icon at the top left)
- ▶ Set the left and right cutting position
- ▶ Confirm (tap the icon at the top left)
  - The video editing submenu appears.
- ▶ Select a function from the **Video editing** menu  
(Save as new, Overwrite, Preview)

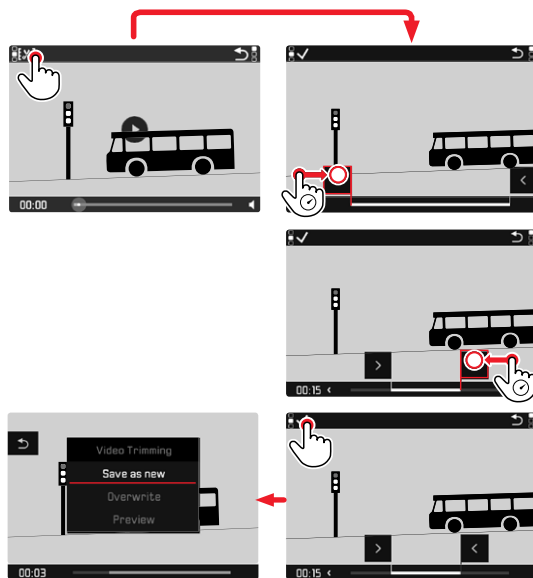

## Using button control

### Accessing the video editing function

- ▶ Press the **FN** button
  - The video editing screen appears, the left cutting mark is highlighted in red (= active).

### Changing and moving cutting points

- ▶ The cutting point on the left is moved with the left setting wheel, the one on the right with the right setting wheel
  - The selected cutting point is highlighted in red (= active).
  - The currently selected time of the relevant cutting point is displayed at the bottom left of the footer line. A still of the video sequence at that point is displayed in the background.

### Cutting

- ▶ Press the **FN** button to confirm the cuts
  - The video editing submenu appears.

#### Note

The editing function can be canceled at any time, provided no selection was made in the **Video editing** menu.

- ▶ Press the **PLAY** button
  - The video playback screen reappears.

- ▶ Select a function from the **Video editing** menu  
(**Save as new**, **Overwrite**, **Preview**)

<b>Save as new</b>	The new video is <b>additionally</b> saved, the original video remains unchanged.
<b>Overwrite</b>	The newly cut video is saved and the original one is deleted.
<b>Preview</b>	The new video is played. The newly cut video is not saved and the original remains unchanged.

#### Note

In all three cases, a notification screen appears while the data is being processed. Then the new video is played back.





## OTHER FUNCTIONS

### USER PROFILES

This camera allows the permanent storage of any menu settings, to e.g. access them quickly and easily for recurring conditions/image objects. Six memory slots are provided to store custom settings, plus the factory setting, which is always available and cannot be modified (**Default Profile**). You can assign names for the saved profiles yourself.

Any profiles configured for the camera can be saved to a memory card for use on another camera. Similarly, profiles saved on a memory card can be transferred to the camera.

## SAVING CURRENT SETTINGS AS A USER PROFILE

### CREATING PROFILES

Saving settings/Creating a profile

- ▶ Create custom settings for the desired functions via menu control
- ▶ Select **User Profile** in the main menu
- ▶ Select **Manage Profiles** in the submenu
- ▶ Select **Save as Profile** in the submenu
- ▶ Select a memory slot
- ▶ Confirm the selection

#### Note

A memory slot can only be deleted via the function **Reset Camera** described in the section "Resetting th camera to factory settings" (see p. 127).

### RENAMING PROFILES

- ▶ Select **User Profile** in the main menu
- ▶ Select **Manage Profiles** in the submenu
- ▶ Select **Rename Profiles** in the submenu
- ▶ Select a profile
- ▶ Enter a name for the profile via the associated submenu keyboard and confirm your input (see p. 46)

## APPLY/ACTIVATE PROFILES

Factory setting: `Default Profile`

- ▶ Select `User Profile` in the main menu
  - A list of profile names will appear if user profiles are saved and activated.
- ▶ Select a profile
  - The selected profile is marked as `active`.
  - Free memory slots appear in gray.

## EXPORTING/IMPORTING PROFILES TO/FROM THE MEMORY CARD

- ▶ Select `User Profile` in the main menu
- ▶ Select `Manage Profiles` in the submenu
- ▶ Select `Export Profiles` or `Import Profiles` in the submenu
- ▶ Confirm the selection

### Note

When importing and exporting, all profile slots are transferred to the card, i.e. including any empty slots. Any existing profiles stored in the camera will be overwritten, during the profile import. Individual profiles cannot be imported or exported.

## DATA MANAGEMENT

### DATA STRUCTURE ON THE MEMORY CARD

#### FOLDER STRUCTURE

The files (= pictures) on the memory cards are saved in automatically generated folders. The first three characters signify the folder number (numerals), the last five the folder name (letters). The first folder is assigned the name "100LEICA", the second "101LEICA". A folder will always be created with the next available number; you can have max. 999 folders.

#### FILE STRUCTURE

The file names in these folders consist of eleven characters. In the factory settings, the first file is named "L1000001.XXX", the second "L1000002.XXX", etc. The first letter can be selected, the "L" from the factory settings denotes the camera brand. The first three characters signify the folder number (numerals). The next four digits denote the sequential file number. Once file number 9999 is reached, then a new folder will be automatically created, in which the file numbering begins at 0001 again. The last three places after the dot denote the file format (DNG or JPG).

#### Notes

- When using memory cards that were not formatted with this camera, the file numbering will begin with 0001 again. Should the memory card already contain a file with a higher number, then numbering will be continued from that number.
- A relevant message will be displayed on the LCD panel once folder number 999 and file number 9999 are reached, and all numbering must be reset.
- Format the memory card and reset the picture number right after to reset the folder number to 100.

## EDIT FILE NAMES

- ▶ Select **Edit File Name** in the main menu
  - A keyboard submenu is displayed.
  - The input line contains the factory setting "L" as the first letter of the file name. Only this letter can be changed.
- ▶ Enter a letter of your choice (see p. 46)
- ▶ Confirm

### Notes

- The change to a file name applies to all subsequent pictures or until a new change is made. The sequential number will not be affected; but it will be reset when a new folder is created.
- During a reset to factory settings, the first letter will always be reset to "L" and a new folder will be created, in which the file numbering will once again start with 0001.

## CREATING A NEW FOLDER

- ▶ Select **Reset Image Numbering** in the main menu
  - A relevant prompt is displayed.
- ▶ Confirm the creation of a new folder (**Yes**) or cancel the new folder (**No**).

### Note

The name part (first letter) of a new folder created this way remains unchanged. The file numbers in that folder will start again at 0001.

## FORMATTING A MEMORY CARD

Memory cards that have already been in use with this camera will usually not require formatting. An unformatted memory card that is inserted into the camera for the first time will have to be formatted. The relevant confirmation screen will be displayed automatically. We recommend formatting memory cards from time to time, because residual data traces (data pertaining to individual pictures) may reduce the card's memory capacity.

- ▶ Select **Format Card** in the main menu
- ▶ Confirm the selection

## Notes

- Never switch off the camera while data transfer is in progress.
- All data previously stored on the memory card will be lost during formatting. Formatting will not be prevented by the deletion protection set for individual pictures.
- All images should therefore be regularly transferred to a safe mass storage medium, e.g. the hard disk of a computer.
- A simple formatting process will initially not irretrievably destroy existing data on the card. Only the directory will be deleted, which means the data will no longer be directly accessible. Data access can be restored with appropriate software. Only data subsequently overwritten when new data is saved will actually be irretrievable.
- A memory card should be formatted again in the camera if it was formatted in another device, e.g. a computer.
- Contact your retailer or Leica Customer Care if the memory card cannot be formatted/overwritten (see p. 151).

## DATA TRANSFER

The picture data on the memory card can be transferred to a computer via a card reader for memory cards. Alternatively, the data can be transferred to a mobile device via the Leica FOTOS app (see p. 130).

## USING RAW DATA (DNG)

You will need specific software for editing data in DNG format, e.g. the professional raw data converter Adobe® Photoshop® Lightroom®.

It allows high-quality conversions of stored raw data. It furthermore provides quality-optimized algorithms for digital color processing, delivering exceptionally low-noise photographs with incredible resolution. During editing, you can adjust parameters like gradation, sharpness etc. in retrospect to achieve the best possible image quality.

You will receive a temporary membership for the Adobe Creative Cloud Foto subscription with the purchase of this camera. You will have to register the camera to use the app (<https://owners.leica-camera.com>).

## RESETTING THE CAMERA TO FACTORY SETTINGS

This function allows you to reset all your custom menu settings back to the factory settings. You can optionally exclude the user profiles, WLAN settings, and image numbering from the reset individually.

- ▶ Select **Reset Camera** in the main menu
  - The prompt "Reset Camera Settings?" appears.
- ▶ Confirm or reject the reset to factory settings (**Yes**) / (**No**)
  - Selecting **No** will cancel the reset and the display will return to the main menu. Selecting **Yes** will trigger additional prompts regarding the settings you can opt to keep.
- ▶ Confirm or reject the reset of the user profiles (**Yes**) / (**No**)
- ▶ Confirm or reject the WLAN settings reset (confirm **Yes**) / (reject **No**)
- ▶ Confirm or reject the reset of the image numbering (**Yes**) / (**No**)
  - The message "Please restart the camera" appears.
- ▶ Switch the camera off and on again
- ▶ Select your language
- ▶ Configure the date and time settings, see p. 52

### Note

You reset the image file numbering separately via the menu item **Reset Image Numbering** (see p. 125)

## FIRMWARE UPDATES

Leica is continuously working on the further improvement and optimization of your camera. Since many camera functions are entirely controlled by software, some of these improvements and additions to the functional scope can be installed in retrospect. Leica offers firmware updates at irregular intervals, which you can download from our website.

Leica will notify you of any new updates, once you have registered your camera.

### Find out which firmware version is currently installed

- ▶ Select **Camera Information** in the main menu
  - The current version designation is displayed next to the menu item **Camera Firmware Version**.

More information about registering, firmware updates and their downloads for your camera, as well as any amendments and additions to the details provided in this manual can be found in the customer area of our website at: <https://owners.leica-camera.com>.

## UPDATING THE FIRMWARE

- ▶ Download the latest firmware version
- ▶ Save the download to the memory card
- ▶ Insert the memory card into the camera
- ▶ Select **Camera Information** in the main menu
- ▶ Select **Camera Firmware Version** in the submenu
- ▶ Select **Start Update** in the submenu
  - The update will start automatically.

### Notes

- The message **Battery low** will appear if the battery is not sufficiently charged. Recharge the battery and then repeat the process described above.
- You will find additional device and country-specific registration marks and numbers in the **Camera Information** submenu.





## LEICA FOTOS

The camera can be controlled remotely using a smartphone/tablet PC. This will require an installation of the Leica FOTOS app on the mobile device.

- ▶ Scan the following QR code with the mobile device



or

- ▶ The app is available from Apple App Store™/Google Play Store™

## CONNECTION

### CONNECTION METHOD

There are two methods for establishing a connection between the camera and a mobile device.

- With WLAN availability:  
the **Join WLAN** method is recommended.

- With no WLAN availability:  
establishing a wired connection (**Create WLAN**) may be most practical.

#### Via the main menu

- ▶ Select **Leica FOTOS** in the main menu

#### From the playback menu

- ▶ Press the **FN** button
  - The playback menu appears.
- ▶ Select **Leica FOTOS**
  - The **Leica FOTOS** submenu is the same that can be accessed via the main menu.

## ABOUT JOINING A WLAN (Join WLAN)

Access to the available Wifi networks is possible with this function. When using this method, the camera and the mobile device are registered on the same WLAN network.

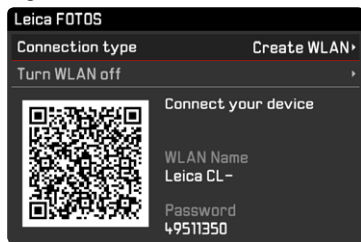

- ▶ Select **Leica FOTOS** in the main menu
- ▶ Select **Connection type** in the submenu
- ▶ Select **Join WLAN** in the submenu
  - The camera automatically lists the available networks.
- ▶ Select the desired network from the list
  - Repeat the search by selecting the menu item **Scan** if the network you are looking for is not listed.
- ▶ Press the center button to confirm the selected network
- ▶ Enter password (where required)

### Notes

- The connection information will be stored until the next reset of the WLAN settings (see p. 127).
- Connections can only be established with 2.4 GHz WLAN networks.

## DIRECT CONNECTION WITHOUT WLAN (Create WLAN)

This function allows access to the camera without an available WLAN network.

In this method, the camera generates an access point for registering your mobile device.



- ▶ Select **Leica FOTOS** in the main menu
- ▶ Select **Connection type** in the submenu
- ▶ Select **Create WLAN** in the submenu

## CONNECTING VIA THE MOBILE DEVICE

### FIRST-TIME CONNECTION TO A MOBILE DEVICE

#### In the camera

- ▶ Providing a WLAN ([Create WLAN](#)) or establishing a connection with an existing WLAN, where the mobile device is registered as well ([Join WLAN](#))

#### On the mobile device

- ▶ Launch the Leica FOTOS app
- ▶ Select "Add Camera"
- ▶ Select the camera model
- ▶ Scan the QR code

### OTHER CONNECTIONS

#### In the camera

- ▶ Providing a WLAN ([Create WLAN](#)) or establishing a connection with an existing WLAN, where the mobile device is registered as well ([Join WLAN](#))

#### On the mobile device

- ▶ Launch the Leica FOTOS app
- ▶ Select the camera model

#### Note

A message screen with a countdown will appear if no connection exists for an extended period of time. The WLAN function will shut down, once the countdown is complete.

## REMOTE CAMERA CONTROL

Leica FOTOS allows controlling the camera remotely to e.g. take pictures or to transfer recordings to the mobile device.

#### Notes

- The camera cannot be operated directly while Leica FOTOS is connected. A prompt to interrupt the WLAN connection will appear if the camera is operated manually.
- The Status LED will flash green while Leica FOTOS is connected.



## CARE/STORAGE

We recommend the following if the camera will not be used for an extended period of time:

- Switch off the camera
- Remove the memory card
- Remove the battery (after approx. 2 months the set date and time will be lost)

## CAMERA HOUSING

- Keep your equipment meticulously clean, as any kind of dirt residue presents a breeding ground for micro organisms.
- Only clean the camera with a soft, dry cloth. Stubborn dirt should first be moistened with a watered-down detergent and can then be wiped away with a dry cloth.
- Wet a soft cloth with tap water, wring it out thoroughly and wipe the camera clean of any salt water spray. Then wipe it down thoroughly with a dry cloth.
- Wipe the camera with a clean, lint-free cloth to remove stains and fingerprints. Tougher dirt is hard to reach corners of the camera housing can be removed with a small brush. Take care not to touch the shutter blades.
- Store the camera in a closed and padded container to prevent friction damage and protect it against dust accumulation.
- Keep the camera in a dry, sufficiently ventilated place, where it will not be subjected to high temperatures and humidity. Make sure to remove all moisture from the camera if it was used in humid conditions.
- Do not store the camera in a leather case for extended periods of time to prevent fungal contamination.

- Empty your camera bag completely if it ever gets wet during use. Your equipment might otherwise be subjected to moisture and tanning residue released by the moist leather.
- All mechanical bearings and sliding surfaces on your camera are lubricated. Remember to press the shutter button several times every three months to prevent the lubrication points hardening if the camera will not be used for an extended period of time. We also recommend repeated adjustment and use of all the other operating elements.
- When using your camera in tropical climates, make sure to expose the equipment to sunlight and fresh air as much as possible to prevent fungal growth. Storage in airtight containers or cases is recommended only in conjunction with a desiccant like silica gel.

## LENS

- A soft-bristle brush will usually suffice to remove dust from the outer lenses. Remove more severe soiling with a clean, soft cloth that is completely free of foreign matter. Wipe the lens in a circular motion from the center outward. We recommend using microfiber cloths that come in a protective container and are available from photography shops and other optical retailers. These cloths are machine-washable at 40°C. Do not use fabric softener and do not iron them. Never use spectacle lens cleaning cloths, as these are soaked in chemicals, which could damage the glass of the camera lenses.
- Attach a transparent UVA filter for optimal front lens protection in unfavorable conditions (e.g. sand, salt water spray). Please remember that the filter may create unwanted light reflections in some backlight situations and in case of high contrasts.
- The lens caps supplied protect the lens against accidental fingerprint smudges and rain.

- All mechanical bearings and sliding surfaces on your lens are lubricated. Make sure to periodically move the focus ring and the aperture setting ring to prevent seizing if the lens will not be used for an extended period of time.

## VIEWFINDER/LCD PANEL

- Switch off your camera and leave it to stand at room temperature for around 1 hour if condensation has formed on or in the camera. The condensation will disappear, once the camera temperature has reached room temperature.

## RECHARGEABLE BATTERY

- Lithium-ion rechargeable batteries should only be stored partially charged, i.e. not fully depleted or fully charged. The camera LCD panel will show the current charge level of the battery. Charge the battery twice a year for around 15 minutes to avoid deep discharge in case of very long storage periods.

## MEMORY CARDS

- Make sure to store memory cards in their anti-static container when not in use.
- Do not store memory cards where they will be exposed to high temperatures, direct sunlight, magnetic fields or static electricity. Always remove the memory card if the camera will not be used for an extended period of time.
- We recommend formatting the memory card from time to time, because fragmented residual data from deleted files may block some of its storage capacity.

## FAQ

Problem	Possible cause to be verified	Troubleshooting suggestions
<b>Battery issues</b>		
Battery is depleted too quickly	Battery too cold	Warm the battery (e.g. in pants pocket) and only insert directly before use
	Battery too hot	Allow battery to cool down
	LCD panel or EVF set too bright	Reduce brightness
	Power save mode deactivated	Activate power save mode
	High consumption AF mode permanently activated	Select other mode
	Permanent WLAN connection	Deactivate WLAN when not in use
	Continuous use of LCD panel/Live View mode	Deactivate the function
Battery has been recharged too many times	The battery has reached the end of its operating time, replace battery	
Charging process not starting	Incorrect battery polarization or faulty charger connection	Check polarization and connection
Charging takes too long	Battery too hot or too cold	Charge the battery at room temperature
Charging pilot light is on, but battery isn't charging	The battery contacts are dirty	Clean the contacts with a soft, dry cloth
	Battery has been recharged too many times	The battery has reached the end of its operating time, replace battery
<b>Camera problems</b>		
The camera suddenly switches itself off	The battery is flat	Charge or replace the battery
The camera won't switch on	The battery is flat	Charge or replace the battery
	Battery is too cold	Warm the battery (e.g. in pants pocket)
The camera doesn't respond	The camera is connected to Leica FOTOS app	Terminate the connection
Camera is heating up	Heat development due to high-res video recording (4K) or serial exposures with DNG	Not a fault; allow camera to cool down if it gets too hot
Camera does not recognize the memory card	The memory card is not compatible or defective	Check the compatibility of the memory card (See "Technical Data")
	Memory card is incorrectly formatted	Format the memory card (Caution: Loss of data!)
<b>Menus and displays</b>		
Viewfinder is dark	EVF brightness is set too low	Set the EVF brightness
Display language is not English	-	Select <b>English</b> in the <b>Language</b> menu



The LCD panel is too dark or too bright/not clear	The brightness setting is incorrect	Adjust the display brightness
<b>Favorites</b> menu does not appear	The favorites menu is empty	Add at least one function
Live View stops suddenly or doesn't start	The camera is hot due to high ambient temperature, extended Live View operation, extended video recording or serial exposures	Allow camera to cool down
The brightness in Live View mode is not the same as in the pictures	The brightness settings for the LCD panel have no influence over the exposures	Adjust the brightness settings as needed
The number of remaining exposures does not count down after a picture is taken	The exposure requires only very little memory space	This is not a fault; the number of remaining exposures is calculated as approximations
<b>Taking pictures</b>		
The camera won't take a picture/shutter button is deactivated	Memory card is full	Replace the memory card
	The memory card is not formatted	Reformat the memory card (Caution: Loss of data!)
	The memory card is write protected	Deactivate the write protection on the memory card (small lever on the side of the memory card)
	Dirt on the memory card contacts	Clean the contacts with a soft cotton or linen cloth
	The memory card is damaged	Replace the memory card
	The sensor is overheating	Allow camera to cool down
	The camera has switched off automatically (automatic shutdown)	Switch the camera on again deactivate auto shutdown as needed
	Picture data is being written to the memory card and the cache is full	Wait
	Noise reduction function is working (e.g. after night photography with long exposure times)	Wait or deactivate noise reduction
Battery is depleted	Charge or replace the battery	
Camera is processing a picture	Wait	
No picture is taken	The camera is connected to the Leica FOTOS app	End connection and reconnect
Image noise appears on the LCD panel/in the viewfinder when the shutter button is pressed to the first pressure point	The gain is increased to aid image composition if the object is insufficiently lit with reduced aperture opening	Not a fault - picture quality will not be impacted
LCD panel/viewfinder deactivates after a very short time	Power Save settings are activated	Change the settings as needed

The display switches off after the picture is taken/ the LCD panel goes dark after the picture is taken	Flash loads after picture is taken, LCD panel deactivates during load time	Wait until the flash is loaded
Camera does not focus	Desired object part is too close to the camera	Increase the distance to the subject
	Object not suitable for AF	Use Focus lock or select manual focus
Flash won't fire	The flash cannot be used with the current settings	Refer to the list of flash function-compatible settings
	Flash is deactivated	Select other flash mode
	The battery is flat	Charge or replace the battery
	Pressing the shutter button while flash is still loading	Wait until the flash is loaded
	Electronic shutter function is selected	Change the setting
	Automatic bracketing or Picture series is activated	Select other mode
The flash does not fully illuminate the object	Object is outside the flash range	Move object into flash range
	Flash is covered	Make sure the th flash unit is not covered by your finger or some object
Image does not sharpen automatically	AF is deactivated	Activate AF
No face detection/faces are not recognized	Face is covered (sunglasses, hat, long hair, etc.)	Remove distracting objects
	Face takes up to little space in the picture composition	Change image composition
	Face is tilted or horizontal	Keep face straight
	Camera not held straight	Hold camera straight
	Face is insufficiently lit	Use flash, improve illumination
Camera selects incorrect object	The incorrectly selected object is closer to the image center than the main object	Change the image section or take picture using the focus lock
	The incorrectly selected object is a face	Deactivate face detection
No continuous recording available	The camera is overheated and the function was temporarily disabled to protect the camera	Allow camera to cool down
The image on the LCD panel displays lots of noise	Light enhancement function of the LCD panel in dark surroundings	Not a fault - picture quality will not be impacted
Image storage takes a long time	Noise Suppression is activated for long-term exposures	Deactivate the function
Manual white balance is unavailable	The image object is too bright or too dark	
Viewfinder is out of focus		Check the diopter setting and adjust as needed
AF metering field is framed in red with activated AF; images out of focus	Focusing was unsuccessful	Try to focus again

No AF metering field selectable	Lock lever for AF in locked position	Move lock lever (on the lens) to unlocked position
	Automatic Metering Field Control, Portrait Mode in the Scene Modes menu or Face Detection in AF mode is selected	Select other control mode
	Image Review is activated	Deactivate Image Review
	Camera is in Standby mode	Press the shutter button to the first pressure point
AF assist light does not light up	The AF mode 'AFc' is selected or 'Continuous AF' is activated in AFs mode.	Change the mode
	Camera is recording a video or is in Live View mode	Change the mode
	Function is deactivated	Activate AF
<b>Video recording</b>		
No video is recorded	The camera is overheated and the function was temporarily disabled to protect the camera	Allow camera to cool down
Video recording stops	Maximum length of individual video sequence was reached	
	The memory card's write speed is too low for the selected video resolution/compression	Insert another memory card or change the storage method
<b>Review/playback and video/image management</b>		
Pictures taken in portrait format are displayed in landscape format	-	Adjust the display options
Selected images cannot be deleted	Some of the selected images are write protected	Remove write protection (using the device with which the file was originally set to write protected)
File numbering does not start at 1	The memory card contains previously stored images	
The time and date settings are incorrect or are not displayed	The camera has not been in use for an extended period of time (the battery was removed)	Insert a charged battery and configure the correct settings
The time and date stamp on images are incorrect	Time settings are incorrect	Set the time correctly Caution: Time settings will be lost if the camera is not used/remains in storage with a depleted battery over an extended period of time
The time and date stamp on images are unwanted	Setting was ignored	Cannot be removed in retrospect Deactivate the function as needed

Pictures/recordings are damaged or missing	The memory card was removed while the readiness indicator was flashing	Never remove the memory card while the readiness indicator is flashing. Charge the battery.
	The memory card formatting is faulty or the card is damaged	Reformat the memory card (Caution: Loss of data!)
Review/playback unavailable	The camera is connected to Leica FOTOS app	Terminate the connection
<b>Picture quality</b>		
The picture is too bright	Light sensor was covered while picture was taken	Make sure that the light sensor is not obstructed
Image noise	long exposure times (>1 s)	Activate the noise suppression function for long exposure times
	ISO sensitivity set too high	Decrease ISO sensitivity
Unnatural colors	White balance not or incorrectly set	Adjust white balance to light source or adjust manually
Round white blotches, similar to soap bubbles	Flash photography in very dark environment: Reflection of dust particles	Deactivate the flash
Images are out of focus	Lens is dirty	Clean the lens
	Lens is obstructed	Make sure that lens is unobstructed
	Camera moved during exposure	Use flash or mount camera on a tripod
Images are overexposed	Flash is activated in bright surroundings	Change the flash mode
Out of focus/picture stabilizer not functioning	Exposure at a dark location without flash	Use a tripod
The image is grainy or there is image noise	ISO sensitivity set too high	Decrease ISO sensitivity
Unnatural colors and brightness	Picture taken in artificial light or extreme brightness	Set white balance or select correct lighting presets
Picture is too white	Strong light source in the image	Avoid strong light sources in picture composition
	Picture is too white	(Half) backlight falling into the lens (also from light sources outside the image range)
No images are displayed	Memory card is empty or not inserted	
Images cannot be displayed	File name of the image was changed on a PC	use appropriate software for image transfers from a PC to the camera; available from the Leica AG website
<b>Video quality</b>		
Video recordings show flickering/stripes	Light source interference in artificial lighting	Select a different frame rate (suitable for the local AC grid frequency) under <a href="#">Video Resolution</a>
Camera noise in video recording	The setting dials were used	Avoid using the setting dials during video recordings

No sound on video recording	Playback volume is set too low	Increase playback volume
	Microphone was covered during recording	Make sure the microphone is not obstructed while recording video
	Speakers are covered	Make sure that speakers are unobstructed during playback
	Microphone was deactivated while recording	Activate the microphone
Flickering or horizontal stripes in the video recording	CMOS sensors will display this phenomenon when light sources like LED lamps or fluorescent tubes are used	Quality may be improved by selecting a manual shutter speed (e.g. 1/100 s)
<b>Smartphones/WLAN</b>		
WLAN connection gets interrupted	Camera deactivates when it overheats (safety feature)	Allow camera to cool down
Smartphone connection/image transfer not working	The smartphone is too far away	Bring the devices closer to each other
	Interference from other devices in the vicinity, e.g. other smartphones or a microwave oven	Increase distance to interfering devices
	Interference from multiple smartphones in the vicinity	Re-establish the connection/remove other smartphones
	Smartphone is currently connected to another device	Check connection
Camera does not appear on the WLAN configuration screen of the smartphone	Smartphone does not recognize camera	Switch the WLAN function of the smartphone off and on again

## INDEX

## Symbol

4K ..... 62

## A

A (Aperture priority) ..... 82

Accessory ..... 3

Acoustic Signals ..... 57

AE-L ..... 84

AF ..... 64

AF assist light ..... 68

AFc ..... 64

AF confirmation ..... 57

AF confirmation, signal ..... 68

AF-L ..... 84

AF operating mode ..... 64

AFs ..... 64

Aperture priority ..... 82

Auto ISO ..... 71

Automatic program ..... 75-76

Automatic review ..... 114

Auto Power Off, LCD panel ..... 56

## B

Bluetooth ..... 6

Bracketing ..... 87

Brightness ..... 55

Brightness, EVF ..... 55

Brightness, LCD panel ..... 55

## C

Care ..... 134

Carry strap ..... 26

Center button ..... 39

Center-weighted metering ..... 74

Charger ..... 151

Charger, preparation ..... 26

Charge status, charger ..... 27

Charge status, LCD panel ..... 28

Charging the battery ..... 27

Clipping ..... 91-106

Color profile ..... 60

Color saturation ..... 59

Color temperature ..... 73

Connection, mobile devices ..... 130

Contrast ..... 59-60

Contrast, video ..... 63

Customer service ..... 152

## D

Data management ..... 124

Date ..... 52

Deactivation, LCD panel ..... 56

Diopter adjustment ..... 32

Diopters ..... 32

Direct access ..... 50-146

Directional pad ..... 39

Display, LCD panel ..... 56

Displays, top display ..... 25

Displays, video ..... 24

DNG ..... 58-127

## E

Editing, video ..... 119

Electronic shutter ..... 94

Electronic shutter sound ..... 57

EVF ..... 54

Exposure compensation ..... 86

Exposure compensation, flash ..... 99

Exposure control, video ..... 103

Exposure metering, flash ..... 96

Exposure, metering method ..... 74

Exposure simulation ..... 83

Eye sensor ..... 55

## F

Face detection ..... 66

Factory settings ..... 127

FAQ ..... 136

Favorites ..... 42

Favorites menu ..... 42-49

Field metering ..... 65

File format ..... 58

File format, video ..... 62

File name ..... 125

File structure ..... 124

File transfer ..... 127

Film style ..... 60

Filter ..... 34

Firmware update ..... 14-128

Fixed ISO value ..... 71

Flash ..... 95

Flash, control ..... 98

- Flash, exposure compensation ..... 99  
Flash, exposure metering ..... 96  
Flash, firing point ..... 98  
Flash, operating mode..... 97  
Flash, range ..... 99  
Flash unit, compatibility..... 95  
FN button ..... 39  
Focus assist..... 70  
Focusing..... 64  
Focusing, manual ..... 69  
Focusing, video ..... 103  
Focus limit ..... 67  
Focus peaking..... 69  
Focus setting, video ..... 103  
Folder structure ..... 124  
Formatting..... 126  
Full HD ..... 62
- G**
- General information ..... 12  
Gray Card ..... 73  
Grid lines ..... 89
- H**
- Histogram ..... 89 106  
Home screen ..... 43  
Horizon..... 90  
Horizon display ..... 90
- I**
- Image properties..... 59  
Image properties, video..... 63  
Image stabilization ..... 61  
Image stabilization, video ..... 63  
Individual button assignment ..... 50  
Information display..... 56  
Interval shooting ..... 92  
ISO Sensitivity..... 71  
ISO value, greatest..... 71
- J**
- JPG ..... 58
- K**
- Keyboard ..... 45  
Key control ..... 42  
Keylock ..... 51
- L**
- Language ..... 52  
LCD ..... 54  
LCD panel, setting..... 54  
Left setting wheel ..... 38  
Left setting wheel button..... 38  
Legal information ..... 4  
Leica Customer Care..... 152  
Leica FOTOS ..... 6 127 130 132  
Lens ..... 33  
Lens, compatibility ..... 34  
Lens hood..... 34  
Lens, lens change ..... 33  
Lens list ..... 34  
Lock ..... 51
- M**
- Magnification ..... 70 107  
Main menu ..... 42 43  
Main switch ..... 36  
Manual focusing..... 69  
Memory card ..... 30 126  
Menu bar ..... 48  
MENU button ..... 40  
Menu control ..... 42  
Menu language ..... 52  
Menu navigation..... 45  
MENU Overview ..... 146  
Menu screen..... 43  
Metering memory lock ..... 84  
Metering method, exposure ..... 74  
MF..... 64 69  
Microphone ..... 62  
M lens ..... 35  
M (Manual exposure setting) ..... 83  
Monochrome ..... 60  
Monochrome photography ..... 60  
Monochrome recording, video ..... 63  
Monochrome, video ..... 63  
Multi-field metering ..... 65 74

- N**
- Number pad..... 46
- O**
- Operating elements..... 34
  - Operating mode, exposure ..... 75
  - Operating mode, flash..... 97
  - Optical image stabilization..... 61
- P**
- Part Designations..... 20
  - P (automatic program)..... 75 76
  - Picture, series..... 91
  - Playback, information screen ..... 105
  - Playback/Review, automatic ..... 114
  - Playback/Review mode..... 104
  - Playback, video ..... 116
  - PLAY button..... 39
  - Power save mode..... 53 56
  - Power saving, automatic..... 53
  - Preview..... 114
- Q**
- Quick access ..... 50
- R**
- R adapter..... 35
  - R adapter L..... 35
  - Rating..... 110
  - Raw data..... 127
  - Rechargeable battery ..... 151
  - Recording, delete ..... 110
  - Recording, interval ..... 92
  - Recording, marking ..... 110
  - Recording mode..... 64
  - Recording mode, video..... 102
  - Recording, rating..... 110
  - Recordings, scrolling..... 105
  - Regulatory information ..... 4
  - Remote control ..... 132
  - Replacement parts..... 3
  - Reset, camera..... 127
  - Reset, image numbering..... 125 127
  - Resolution..... 58
  - Resolution, video..... 62
  - Right setting wheel..... 38
  - Right setting wheel button..... 38
  - R lens ..... 35
- S**
- Safety remarks..... 8
  - Saturation..... 59 60
  - Saturation, video..... 63
  - Scale ..... 48
  - Scene mode ..... 77
  - Scope of delivery ..... 2
  - Self-timer..... 94
  - Serial exposures ..... 91
  - Setting, video..... 62
  - Setting wheel..... 38
  - Sharpness..... 59 60
  - Sharpness, video..... 63
  - Shift ..... 76
  - Shortcut ..... 50
  - Shutter button..... 37
  - Shutter, electronic..... 94
  - Shutter priority mode ..... 81
  - Shutter release ..... 37
  - Shutter speed/aperture combination .... 76
  - Signal ..... 57
  - Slideshow ..... 115
  - SL lens ..... 34
  - Sound..... 62
  - Spot metering ..... 65 74
  - S (Shutter speed priority mode)..... 81
  - Standby mode..... 53 56
  - Storage..... 134
  - Submenu ..... 43
  - Switching off, camera..... 36
  - Switching on, camera..... 36
  - Sync point ..... 98
- T**
- Technical Data ..... 148
  - Time ..... 52 53
  - Time zone ..... 53
  - TL lens..... 34
  - Top display..... 41
  - Touch AF..... 67
  - Touch control..... 40
  - Touch screen ..... 40
  - Tracking..... 66



TTL metering..... 96

## U

USB ..... 127

User profiles ..... 122

## V

Video mode ..... 102

Video stabilization..... 63

Video Style ..... 63

Viewfinder, setting..... 54

Volume, video ..... 119

## W

Warning signal ..... 57

Warranty ..... 15

White balance ..... 72

Wind noise reduction ..... 62

WLAN ..... 6■130

## MENU OVERVIEW

### DIRECT ACCESS

Available settings: ●

Factory setting: ●

	Favorites menu	FN button	Right setting wheel button	Page
Picture series	● ●	●	●	87, 91-92
Interval	●	●	●	92
Bracketing	●	●	● ●	87
Self-timer	●	● ●	● ●	50, 94
Focusing	● ●	●	●	64-70
AF-L		●	●	66, 84-85
AE-L		●	●	84-85
AF-L + AE-L		●	●	66, 84-85
Focus mode	●	●	●	64
Focus Limit		●	●	67-68
AF mode	●	●	●	65
Focus assist	●			69-70
Auto Enlargement		●	●	70
Focus Peaking		●	●	69
Exposure Metering	● ●	● ●	● ●	74
Exposure Compensation	●	● ●	●	86-87
ISO	●	●	● ●	50, 71
Auto ISO Settings	●	●	●	71
White Balance	●	● ●	● ●	72-73
Gray Card	●	●	●	73
Color Temperature		●	●	73

	Favorites menu	FN button	Right setting wheel button	Page
Photo File Format	●	● ●	● ●	58
JPG Resolution	●	●	●	58
Film Style	● ●	●	●	60
Scene Modes	●	● ●	● ●	79-82
Optical Image Stabilization	●	●	●	61
Electronic Shutter	●	●	●	94
Flash Settings	●	●	●	98-100
Exposure Preview	●	●	●	83
User Profile	● ●	● ●	● ●	122-123
Video Resolution	●	●	●	62
Video Style	● ●			63
EVF LCD		●	●	54
Lens Profiles	●	●	●	35
M lenses		●	●	35
R lenses		●	●	35
Customize Control	●			39, 49-50, 85
Edit Favorites	●			49
Leica FOTOS	● ●	● ●	●	130-131
Wheel Lock in Live View	●	●	●	51
Format Card	●	●	●	126

## TECHNICAL DATA

### CAMERA

#### Designation

Leica CL

#### Camera type

Digital APS-C system camera

#### Type no.

7323

#### Order No.

19 300 (silver) / 19 301 (black)

#### Buffer memory

DNG™: 14 recordings

JPG: 25 recordings

#### Storage medium

UHS-II (recommended), UHS-I, SD/SDHC/SDXC memory card

#### Material

Top panel and bottom cover: Milled and anodized aluminum  
front and rear housing panels: Magnesium

#### Lens mount

Leica L bayonet with contact strip for communication between lens and camera

#### Compatible lenses

Leica TL and SL lenses, Leica M and R lenses via Leica M or R adapter L

#### Tripod thread

A 1/4 DIN 4503 (1/4") with stainless steel in the base

#### Operating conditions

0/+40°C

#### Dimensions (WxHxD)

131 x 78 x 45 mm

#### Weight

approx. 403 g/637 g (with/without battery)

### SENSOR

#### Sensor size

CMOS sensor, size APS-C (23.6 x 15.7 mm) with 24.96/24.24 million pixels (total/effective), aspect ratio: 3:2

#### File formats

Photo: DNG™ (raw data), DNG+JPG, JPG

Video: MP4

#### Picture resolution

DNG™: 6016 x 4014 pixels (24 MP)

JPG: 6000 x 4000 pixels (24 MP), 4272 x 2856 pixels (12 MP), 3024 x 2016 pixels (6 MP)

#### Color depth

14 bit

#### Color space

Photo: sRGB

Video: sRGB

#### File size

DNG™: 44 MB, JPG: depending on resolution and image content

#### Video resolution/frame rate

 (3840 x 2160 pixels): 30 fps

 (1920 x 1080 pixels): 30 fps, 60 fps

 (1280 x 720 pixels): 30 fps

### VIEWFINDER/LCD PANEL

#### Viewfinder (EVF)

Resolution: 1024 x 768 pixels (2.36 MP), magnification: 0.74x, aspect ratio: 4:3, exit pupil position: 20 mm, setting range +4/-4 diopters, with eye sensor for automatic switchover between viewfinder and LCD panel

#### LCD panel

3" TFT LCD, 1.04 MP, touch control available

## Top display

Resolution: 128 x 58 pixels

## SHUTTER

### Shutter type

Focal Plane Shutter

### Shutter speeds

Mech. shutter: 30 s to 1/8000 s

Electronic shutter function: 1 s to 1/25000 s

Flash synchronization: to 1/250 s

### Shutter button

Two-step (1. step: Activation of the camera electronics including exposure metering and metering memory lock (in aperture priority mode); 2. step: firing)

### Self-timer

Delay time: 2 s or 12 s

### Picture series

Continuous Low Speed: 2 fps

Continuous Medium Speed: 5 fps

Continuous Medium Speed: 10 fps

## FOCUSING

### Setting

Automatic (Autofocus) or manual

With manual setting: optional magnifying glass function (Auto Magnification) and edge marking (Focus Peaking) available as focus aids

### Autofocus system

Based on contrast metering

### Autofocus modes

AFs, AFO (with both metering methods, a picture can be taken at any time), AF setting can be saved

## Autofocus metering methods

Spot (can be shifted), Field (can be shifted), Multi-field, Face detection, object Tracking, optional Touch AF

## EXPOSURE

### Exposure metering

TTL (exposure metering through the lens)

### Exposure Metering Methods

Spot, Center-Weighted, Multi-Field

### Exposure modes

Automatic program (P), Aperture priority mode (A), Shutter speed priority (S),

Automatic (Szene Programme): Full AUTO, Sports, Portrait, Landscape, Night Portrait, Snow / Beach, Fireworks, Candle Light, Sunset, Digiscoping, Miniature Effect, Panorama, HDR

Manual: Manual settings for shutter speed and aperture

### Exposure Compensation

± 3 EV in 1/3 EV increments

### Automatic bracketing

3 or 5 pictures in increments of 1, 2 or 3 EV

### ISO sensitivity range

Auto ISO: ISO 100 to ISO 50000

Manual: ISO 100 to ISO 50000

### White balance

Automatic (Auto), presets (Daylight, Cloudy, Shadow, Tungsten, Flash), one memory slot for manual measurements (Gray Card), manual color temperature setting

## FLASH

### Flash unit connector

About the accessory shoe

### Flash sync time

⬅️ : 1/250 s, slower shutter speeds available, automatic changeover to TTL linear flash mode with HSS-compatible Leica system flash units if sync time is undercut

### Flash exposure metering

Using center-weighted TTL pre-flash metering with Leica flash units (SF 26, 40, 40MkII, 58, 60, 64) or with system-compatible flash units, flash remote control SF C1

### Flash exposure compensation

SF 40: ±2 EV in 1/2 EV increments

SF 60: ±2 EV in 1/3 EV increments

## EQUIPMENT

### Microphone

Stereo

### Speaker

Mono

### WLAN

The Leica FOTOS app is required to use of the WLAN function. The Leica app is available from the Apple App Store™ or the Google Play Store™. Complies with IEEE 802.11b/g/n standard (standard WLAN protocol), channel 1-11, encryption method: WLAN-compatible WPA™/WPA2™, Access method: Infrastructure mode

### Menu languages

English, German, French, Italian, Spanish, Russian, Japanese, Simplified Chinese, Traditional Chinese, Korean

### Firmware Version

3.0

## POWER SUPPLY

### Rechargeable battery (Leica BP-DC12)

Lithium-ion battery, rated voltage 7.2 V (7.2 V DC); capacity 1200 mAh, approx. 220 recordings (based on CIPA standard); charging time approx. 140 min (after deep discharge); manufacturer: Panasonic Energy (Wuxi) Co. Ltd., Made in China

### Charger (Leica BC-DC12)

Input: AC 100–240 V, 50/60 Hz, automatic switchover; output: DC 8.4 V 0.65 A; manufacturer: Shin Tech Engineering Ltd., Made in China

## LEICA CUSTOMER CARE

Please contact the Customer Care department of Leica Camera AG for the maintenance of your Leica equipment and for help and advice regarding Leica products and how to order them. You can also contact the Customer Care department or the repair service provided by your regional Leica subsidiary for repairs or warranty claims.

### **Leica Camera AG**

Leica Customer Care  
Am Leitz-Park 5  
35578 Wetzlar  
Germany

**Phone:** +49 (0)6441 2080-189

**Fax:** +49 (0)6441 2080-339

**Email:** [customer.care@leica-camera.com](mailto:customer.care@leica-camera.com)  
[www.leica-camera.com](http://www.leica-camera.com)

## LEICA ACADEMY

Have a look at our full seminar program with many interesting workshops on the topic of photography at:

[us.leica-camera.com/Leica-Akademie/Global-Leica-Akademie](http://us.leica-camera.com/Leica-Akademie/Global-Leica-Akademie)

