



LEICA D-LUX

Instructions

Finding the information you need

In these instructions, you can find the information you need from the following pages.

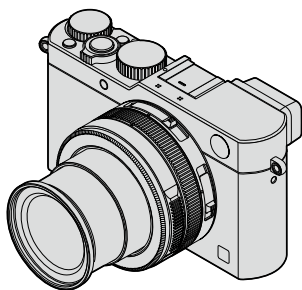

Table of Contents → P.4 -

Function Name List
"Contents by Function" → P.10 -

The Main Parts → P.14 -

Monitor/Viewfinder Display List → P.263 -

On-Screen Message List
"Message displays" → P.269 -

Menu List
"Menu list" → P.273 -

[Rec]	P.273	[Setup]	P.278
[Motion Picture].....	P.275	[Playback].....	P.279
[Custom]	P.276		

Q&A Troubleshooting → P.280 -

For details on how to use these instructions, see the next page.

Wi-Fi® function →221

Recording mode icons

Recording modes: **A** **P** **A** **S** **M**

In recording modes indicated by black icons, you can select and execute the indicated menus and functions.

■ About the symbols in the text

MENU Indicates how the menu item can be set after pressing the [MENU/SET] button.

WIFI Indicates how the Wi-Fi setting can be made after pressing the [WIFI] button.

[AF/AE], [DISP], [, etc. Indicate the respectively labeled buttons



Settings that can be performed in the [Custom] menu.



Application tips





Conditions in which a particular function cannot be used.

(→00) Indicates the reference page.



Click to view the description on the next page.

In these instructions, steps for setting a menu item are described as follows:

MENU →  **[Rec]** → **[Quality]** → [.

- Finding the information you need 2
- How to use these instructions 3
- Contents by Function 10

Before Use

- Before Use 12
- Scope of Delivery 13
- Accessories 13
- The Main Parts 14
 - [MENU/SET] button / Cursor buttons / Control dial 18

Preparations

- Attaching the lens cap and shoulder strap 19
- Charging the Battery 20
 - Remaining battery capacity 21
 - Guidelines for the number of recordable pictures and the operating time 22
- Inserting and Removing the Battery / the Card 24
- About Cards That can be Used 25
 - Formatting the card (initialization) 26
 - Recording capacity guidelines (pictures/recording time) 27
- Setting Language, Time, and Date ... 29
 - Changing time settings 30
- Menu Control 31
 - Setting the menu screen background 33
- The Quick Menu 34
 - Customizing the Quick Menu 35
- Assigning Frequently Used Functions to the Function Buttons ... 37
- Changing Settings Using the Control Ring 39
 - Changing the settings assigned to the control ring 40
- The [Setup] Menu 41
 - [Clock Set] 41
 - [World Time] 41
 - [Travel Date] 42
 - [Wi-Fi] 42
 - [Beep] 43
 - [Live View Mode] 43
 - [Monitor Display] / [Viewfinder] 44
 - [Monitor Luminance] 45
 - [Sleep Mode] 46
 - [USB Mode] 47
 - [TV Connection] 47
 - [Menu Resume] 49
 - [Menu Background] 49
 - [Menu Information] 49
 - [Language] 49
 - [Version Disp.] 50
 - [Self Timer Auto Off] 50
 - [No.Reset] 50
 - [Reset] 50
 - [Reset Wi-Fi Settings] 51
 - [Format] 51
- Entering Text 52

Basics

- **How to Hold the Camera** 53
- **Using the Viewfinder** 54
 - Switching between monitor and viewfinder.....54
 - About Eye Sensor AF55
- **Taking Still Pictures**..... 56
- **Recording Motion Pictures** 58
- **Selecting the Recording Mode** 59
- **Switching Information Displayed on the Recording Screen** 62
- **Viewing Your Pictures** 67
 - Viewing motion pictures.....70
- **Switching the Display Information of the Playback Screen**..... 71
- **Deleting Pictures**..... 73
 - [Delete Single]73
 - Deleting multiple (up to 100)/all pictures...74

Recording mode

- **Using Snapshot Mode** 75
 - Taking pictures using the camera handheld ([i]Handheld Night Shot)78
 - Combining several exposures into a single picture with rich gradation ([i]HDR).....79
- **Taking Pictures Using the Exposure Control Modes P, A, S, and M** 80
 - Program Mode81
 - Aperture-Priority Mode.....83
 - Shutter-Priority Mode.....84
 - Manual Exposure Mode.....86
 - Checking the effects of aperture value and shutter speed ([P]review Mode).....88

Picture effects (Filter)

- **Taking Pictures Using Additional Effects (Filter)**..... 89

Picture Quality and Coloring Settings

- **Adjusting the Picture Quality by Adding an Effect [Photo Style]..... 100**
- **Adjusting Bright / Dark Sections [Highlight Shadow] 102**
- **Setting the White Balance..... 103**
- **Setting Picture Quality and Resolution 107**
 - Changing the aspect ratio of still pictures.....107
 - Setting the resolution.....108
 - Setting the compression rate of pictures ((Quality))109
- **Using the Picture Correction Functions Effectively.....111**
 - Correcting contrast and exposure ((i.Dynamic))..... 111
 - Enhancing the impression of high resolution ((i.Resolution)) 111
 - Combining still pictures with different exposures (([HDR]))..... 112
 - Reducing the noise in long exposures (([Long Shtr NR]))..... 113
 - Setting the color space 113

Focus and Exposure Settings

- **Using Autofocus 114**
 - Selecting the focus mode (AFS, AFF, AFC) 114
 - Switching [AF Mode]..... 115
 - Changing the position and size of the AF area121
 - Setting your preferred focusing method..... 124
- **Taking Close-Up Pictures..... 126**
 - Focusing range.....126
- **Manual Focusing.....128**
 - MF Assist131
- **Focus and Exposure Memory Lock..... 133**
- **Exposure Compensation..... 135**
- **Setting the ISO Sensitivity 136**
 - Setting the upper ISO sensitivity limit 137
 - Setting the ISO sensitivity setting increments 138
 - Extending the ISO sensitivity setting 138
- **Selecting the Exposure Metering Mode [Metering Mode]..... 139**

Shutter and Drive Settings

- **Setting the Shutter Type..... 140**
- **Selecting a Drive Mode..... 141**
- **Using Continuous Mode..... 142**
- **Using [Auto Bracket] 145**
- **Using Aspect Bracketing..... 147**
- **Using the Self-Timer 148**
- **Creating Panorama Pictures..... 150**

Functions for Specific Subjects and Purposes

- **Taking Pictures Automatically at Set Intervals**
[Time Lapse Shot] 153
- **Creating Stop Motion Pictures**
[Stop Motion Animation] 156
- **Making Multiple Exposures for a Single Picture**
[Multi Exp.] 160
- **Disabling Operational Sounds and the Light Sources at the Same Time** [Silent Mode] 162
- **Using the Face Recognition Function** [Face Recog.] 163
- **Recording Profiles of Children and Pets on Pictures** 166
- **Using Screens and Displays for Specific Recording Conditions** 167

Stabilizer, Zoom and Flash

- **Compensating Camera Shake** 169
- **Using the Lens' Zoom Function** 171
Zoom types and use 172
- **Using the Supplied Flash Unit** 177
Attaching the flash unit 177
Changing the flash control mode 180
Changing the flash modes 181
Setting 2nd curtain sync 183
Flash exposure compensation 184
Synchronizing the flash output to an exposure compensation setting for the ambient light 184

Recording Motion Pictures

- **Recording Motion Pictures** 185
Setting the resolution and the frame rate 185
How to focus when recording a motion picture ([Continuous AF]) 186
Recording motion pictures 187
Recording motion pictures in 4K 191
Creating a high-resolution still picture from a 4K motion picture [4K PHOTO] 192
- **Taking Still Pictures While a Motion Picture is Being Recorded** 195
- **Using the [Motion Picture] Menu**... 196
[4K PHOTO] 196
[Rec Quality] 196
[Picture Mode] 196
[Continuous AF] 196
[Mic Level Disp.] 197
[Mic Level Adj.] 197
[Wind Cut] 197

Playing Back and Editing Pictures

■ Viewing Group Pictures	198	[Time Lapse Video]	212
■ Capturing Still Pictures From Motion Pictures	200	[Stop Motion Video]	212
■ Using the [Playback] Menu	201	[Resize]	213
[Slide Show]	201	[Cropping]	214
[Playback Mode]	203	[Rotate] / [Rotate Disp.]	215
[Location Logging]	204	[Favorite]	216
[RAW Processing]	205	[Print Set]	217
[Title Edit]	208	[Protect]	218
[Text Stamp]	209	[Face Rec Edit]	219
[Video Divide]	211	[Picture Sort]	220
		[Delete Confirmation]	220

Wi-Fi

■ Wi-Fi® and NFC Functions	221	■ About Connections	239
■ What You Can do With the Wi-Fi Function	224	[Via Network]	
■ Operating the Camera by Connecting it to a Smartphone	225	Connecting via a wireless access point	240
Installing the smartphone/tablet app "Leica Image Shuttle"	225	[Direct]	
Connecting to a smartphone	226	Connecting directly	243
Connecting to a smartphone using the NFC function	230	Connecting quickly with the same settings as used previously	
Taking pictures via remote control with a smartphone	231	([Select a destination from History] / [Select a destination from Favorite])	244
Playing back pictures in the camera on a smartphone	232	Settings for sending pictures	246
Saving pictures from the camera to the smartphone	232	■ [Wi-Fi Setup]	247
Easily transferring pictures from the camera	233		
Sending pictures from the camera to social networking services	234		
Adding location information to pictures in the camera from a smartphone	234		
Operating the camera to send pictures to a smartphone	236		

Connecting with other devices

■ Enjoying 4K Motion Pictures	248	■ Storing Recorded Still and Motion Pictures on a Recorder	256
Viewing 4K motion pictures	248	Copying by inserting the card into the recorder	256
Storing 4K motion pictures.....	248	Dubbing playback pictures via an AV cable.....	256
■ Viewing on a TV Screen	249	■ Printing pictures	257
HDTV Link (HDMI).....	251	Printing multiple pictures.....	258
■ Copying the Recorded Image Data to a Computer	253	Printing with date and text	259
Copying the data.....	254	Making print settings on the camera.....	260

Others

■ Using Optional Flash Units	261	■ Q&A Troubleshooting	280
■ Monitor/Viewfinder Displays	263	■ Usage Cautions and Notes	294
■ Message Displays	269	■ Leica Service Addresses	301
■ Menu List	273		



Still Picture Recording

Recording

Recording mode	59
[Preview]	88
Picture effects (Filter)	89
Macro recording	126
Recording panorama pictures	150
[Time Lapse Shot]	153
[Stop Motion Animation]	156
[Multi Exp.]	160
[Silent Mode]	162

Focusing (AF/MF)

Focus Mode	114
AF Mode	115
Adjusting the AF area position	121
Manual Focus	128
AF/AE Lock	133

Exposure Control

AF/AE Lock	133
Exposure Compensation	135
ISO sensitivity	136
[Metering Mode]	139
[Auto Bracket]	145

Drive Modes

Drive Mode	141
[Aspect Bracket]	147
[Self Timer]	148

Picture and Color Settings

[Photo Style]	100
[Highlight Shadow]	102
White Balance	103
[Picture Size]	108
[Quality]	109
[i.Dynamic]	111
[i.Resolution]	111
[HDR]	112
[Long Shtr NR]	113
[Color Space]	113

Flash Operation

[Flash Mode]	181
2nd curtain synchro	183
[Flash Adjust.]	184

Screen settings

[Monochrome Live View]	168
[Mic Level Disp.]	197



Motion Picture Recording

Motion Pictures

[Rec Quality]	185
Motion pictures in 4K	191
[4K PHOTO]	192
Taking still pictures while a motion picture is being recorded	195

Audio Recording

[Mic Level Adj.]	197
[Wind Cut]	197



Setup/Customization

Basic settings

[Clock Set]	29
How to set menu items	31
[Q.MENU]	34
[Beep]	43
[Sleep Mode]	46
[Reset] (initialization)	50
Dioptr adjustment	55
Display switching	62, 71

Customization

[CUSTOM] in the Quick Menu	35
Function buttons	37
Control ring	40
Custom Set	60
[Custom] menu	276
[Cursor Button Lock]	38
Motion picture button	189



Playback

Playback

[Auto Review]	57
Picture playback	67
Playback Zoom	68
Multi Playback	68
Motion picture playback	70
Delete	73

Display/playback settings

[Slide Show]	201
[Rotate]/[Rotate Disp.]	215

Editing

[RAW Processing]	205
[Resize]	213
[Cropping]	214

Adding information

[Location Logging]	204
[Title Edit]	208
[Text Stamp]	209

Image settings

[Favorite]	216
[Print Set]	217
[Protect]	218



Wi-Fi

Connecting

"Image Shuttle"	225
NFC	230
[WPS (Push-Button)]	240, 243
Direct connection	243

Image Shuttle

Remote recording	231
Saving images	232
Sending images	233, 236
Sending and adding location information ..	234
[Touch Sharing]	247



Connecting with other Devices

Computer

Software available for download	253
---------------------------------------	-----

TV

[HDTV Link]	251
-------------------	-----

Recorder

Dubbing	256
---------------	-----

Printer

PictBridge	257
------------------	-----

Before Use

■ Camera handling

Do not subject it to excessive vibration, force, or pressure.

- Otherwise, the lens, the monitor, or the external body may be damaged. Besides, the camera may also malfunction or the image may not be recorded.

The camera is not dust/splash resistant, or waterproof.

Avoid using the camera in places with a lot of dust, water, sand, etc. such as on a rainy day or at the beach.

- Liquids, sand and other foreign material may enter through the gaps around the lens, the buttons, etc. Be particularly careful since it may not just cause malfunctions, but it may also cause irreparable damage.

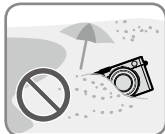
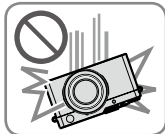

■ Condensation (When the lens, the monitor, or the viewfinder, is fogged up)

- Condensation may occur when the camera is exposed to sudden changes of temperature or humidity. Avoid these conditions, which may make the lens, monitor, or viewfinder, dirty, cause mold, or damage the camera.
- If condensation does occur, turn off the camera and wait about two hours before using it. Once the camera adjusts to the surrounding temperature, the fogging will clear naturally.

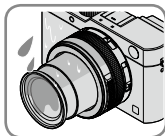

■ Always take a test shot first

Before important events when you will use the camera (at weddings, for example), always take a test shot to make sure that pictures and sound record correctly.

■ No compensation for missed shots

Leica Camera AG cannot compensate for missed shots if technical problems with the camera or card prevent recording.

■ Carefully observe copyright laws

Unauthorized use of recordings that contain works with copyright for purposes other than personal use is prohibited under copyright law. Recording of certain material may be restricted even for the purpose of personal use.

■ Also refer to “Usage Cautions and Notes” (→294)

Scope of Delivery

	Order-No.
Rechargeable battery	
BP-DC15-E	18 544
BP-DC15-U	18 545
BP-DC15-TK	18 546
Battery charger	
BC-DC15-E	423-109.001-010
BC-DC15-U	423-109.002-010
Mains cable	
Korea	423-114.001-003
Taiwan	423-114.001-004
EU	423-114.001-005
China	423-114.001-006
UK	423-114.001-007
Australia	423-114.001-008 (delivery differs depending on markets)
Flash unit CF D	423-109.001-030
USB-Cable	423-114.001-010
Carrying strap	423-109.001-020
Lens cap	423-109.001-018
Lens cap string	423-109.001-019
Hot shoe cover	423-109.001-015
CD with instr.-PDFs	423-109.001-016
Button template for Canada (French)	423-114.001-009 (only with camera model 18 471)
Short instructions	93 588-592 (delivery differs depending on markets)
Guarantee Card	439-399.100-026

Accessories

	Order-No.
Carrying straps	
Artisan & Artist for Leica, satin, green	14 884
Carrying strap D-Lux (Typ 109), leather, cognac	18 824
Wrist straps	
Artisan & Artist for Leica, satin, green	14 885
Wrist strap D-Lux (Typ 109), leather, cognac	18 823
Cases	
Protector D-Lux (Typ 109), leather, cognac	18 820
Case for D-Lux 6 (Typ 109), leather, cognac	18 821
Twist D-Lux (Typ 109), Alcantara, black	18 822
System cases	
size S, Nylon, black	18 746
size S, Leather, gray	18 761
Artisan & Artist for Leica, size M, leather-Nylon, black	14 883
Handgrip D-Lux (Typ 109)	18 547
Automatic lens cap	18 548
Flash unit	18 694
Leica CF 22	
Tripods	
Mini tripod	14 100
Travel tripod, carbon fiber	14 101
Ball heads	
Ball head 18, short, black/silver	14 108 / 14 109
long, black/silver	14 110 / 14 112
Ball head 24	14 113
Ball head 38	14 114
SD- and credit card sheath, black / cognac	18 538 / 18 539

Notes:

- Memory cards are optional.
- Check that all items belonging to the scope of delivery are included before using the camera.
- Depending on the country or area where the camera was purchased, the items and their shape may differ from the descriptions and illustrations in these instructions.
- Always keep small parts in a safe place out of the reach of children.
- Please dispose of all packaging appropriately.

The Main Parts

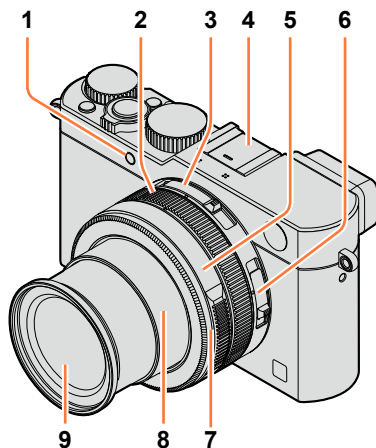

- | | |
|---|--|
| 1 | Self-timer indicator (→148) / AF Assist Lamp (→53, 125) |
| 2 | Control ring (→39) |
| 3 | Aspect ratio selector switch (→107) |
| 4 | Hot shoe (Hot shoe cover) (→177)
The hot shoe cover is inserted at the time of purchase. |
| 5 | Aperture ring (→59) |
| 6 | Focus selector switch (→114, 126, 128) |
| 7 | Lens front ring
To attach the auto lens cap (optional), remove the lens front ring. |
| 8 | Lens barrel |
| 9 | Lens |

The Main Parts

(Top)

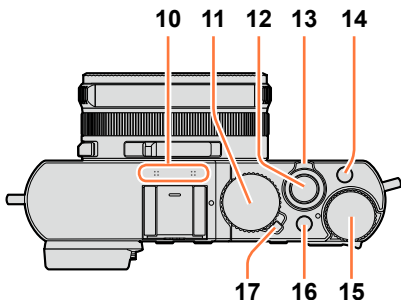

- 10 **Stereo microphone** (→53, 197)
Be careful not to cover the microphone with your finger. Doing so may impair sound recording.
- 11 **Shutter speed dial** (→59)
- 12 **Shutter button**
- 13 **Zoom lever** (→171)
- 14 **[F] (Filter) button** (→89)
- 15 **Exposure compensation dial** (→135)
- 16 **[A] button** (→59)
- 17 **Camera [ON/OFF] switch**

(Bottom)

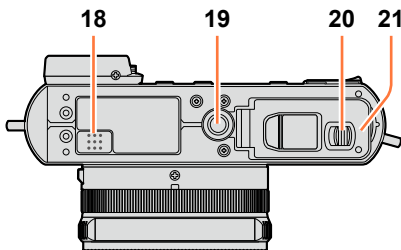

- 18 **Speaker**
Be careful not to cover the speaker, e.g. with your finger. Doing so may impair sound audibility.
- 19 **Tripod thread** (→297)
Using tripod screws with lengths of 5.5mm ($1/32$ ") or more may damage the camera if attached.
- 20 **Release slider** (→24)
- 21 **Card/Battery door** (→24)

The Main Parts

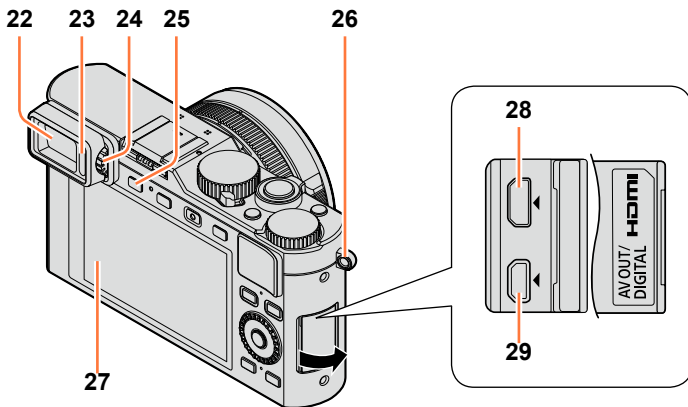
**22 Viewfinder (EVF)** (→54)

In these instructions, “viewfinder” is used to indicate the EVF.

23 Eye Sensor (→54)**24 Diopter adjustment wheel** (→55)**25 [EVF] button** (→54) / **[Fn3] button** (→37)**26 Strap eyelet** (→19)**27 Monitor****28 [HDMI] socket** (→249)**29 [AV OUT/DIGITAL] socket** (→249, 254, 256, 257)

The Main Parts

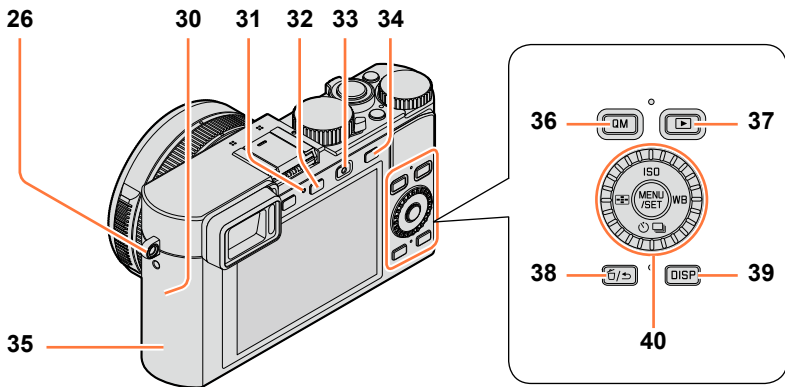

- 26 **Strap eyelet** (→19)
- 30 **Wi-Fi® antenna**
- 31 **Wi-Fi connection lamp** (→222)
- 32 **[WIFI]/[Fn2] button** (→222)
- 33 **Motion picture button** (→58)
- 34 **[AF/AE] button** (→133)
- 35 **NFC antenna** (→230)
- 36 **[QM] button** (→34)
- 37 **Playback button** (→67)
- 38 **[C/↵] (Delete/Cancel)/[Fn1] button** (→32, 73)
- 39 **[DISP] button** (→62, 71)
- 40 **[MENU/SET] button / Cursor button / Control dial** (→18)

● The illustrations and screens in these instructions may differ from the actual product.

[MENU/SET] button / Cursor buttons / Control dial

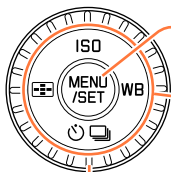

[MENU/SET] button

Use this button to call up the menus, enter the settings, etc. (→31)

Cursor button

This button is used to move the cursor on the menu screens and for other functions. (→32)

You can perform the following operations while recording.

[ISO] button (▲) (→136)

[WB] (White Balance) button (▶) (→103)

[Drive Mode] button (▼)

Single (→141), Continuous (→142), Auto Bracket (→145),

Aspect Bracket (→147), Self-timer (→148), Panorama (→150)

[AF Mode] button (◀) (→115, 131)

Control dial

Turn the dial to select setting items and change setting values. (→32, 67)





Disabling the button and dial operation (while recording)

When [Cursor Button Lock] is assigned to a function button, operation of the [MENU/SET] button, the cursor button, and the control dial is disabled. (→38)



Enabling/disabling the operation guide display

MENU → **⌘C [Custom]** → **[Dial Guide]** → **[ON] / [OFF]**

- When you set the operation guide to [ON], the operation guide for the control ring ([]), control dial ([]), and other parts appear on the recording screen.



- In these instructions, the button to be used is indicated by ▲▼◀▶.

Attaching the lens cap and shoulder strap

Cover the lens with the lens cap to protect it whenever you are not using the camera. We recommend attaching the lens cap using the lens cap string to prevent its loss. We also recommend attaching the carrying strap to prevent the camera from being dropped.

1 Use the lens cap string (supplied) to attach the lens cap to the camera

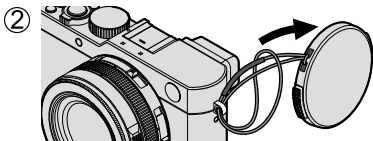
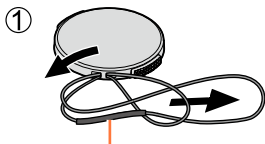

Make sure that the thicker part of the string is not hanging over the lens cap or the shoulder strap eyelet.

2 Attach the lens cap

To attach and remove the lens cap, press the tabs shown by arrows in the illustration.

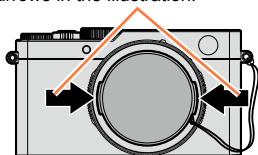

3 Attach the carrying strap

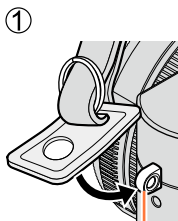

Shoulder strap eyelet

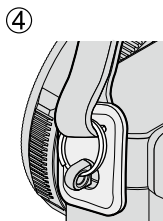
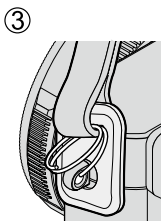
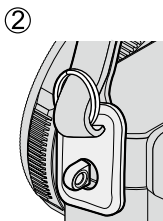

- Attach the other end the same way.
- Make sure it does not loosen.
- Attach it with the Leica logo on the strap facing out.
- Do not wrap the strap around your neck. It may result in injury or accident.
- Do not leave the carrying strap where a child can reach it.
 - This may result in the child accidentally strangling itself.

Charging the Battery

Always charge before the first use! (the battery is shipped uncharged)

About batteries that you can use with this camera

It has been found that counterfeit batteries which look very similar to the genuine product are available in some markets. Some of these batteries are not adequately equipped with internal protection to meet the requirements of appropriate safety standards. Using such batteries may lead to fire or explosion. Please be advised that Leica Camera AG is not liable for any accident or failure occurring as a result of use of a counterfeit battery. To ensure that safe products are used we urgently recommend to use only the Leica battery BP-DC15 (→13).

- Use only the dedicated charger and battery.

1 Insert the battery into the charger

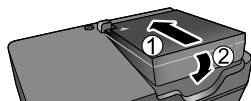

2 Connect the charger to an electrical outlet

Plug-in type

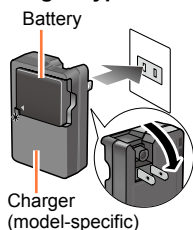

Inlet type

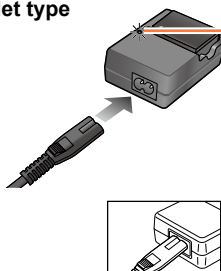

Charging light ([CHARGE])

On: Charging in progress
Off: Charging complete

If the light is flashing:

- Battery temperature is too high or too low. We recommend charging in a location where the ambient temperature is between 10°C and 30°C (50°F to 86°F).
- Battery/charger connector is dirty. Clean with a dry cloth.

- Charge the battery indoors.

3 Remove the battery after charging is completed

- The battery charger is in a standby condition as long as AC power is supplied. The primary circuit is always "live" as long as the battery charger is connected to an electrical outlet.

Notes on charging time

Charging time	approx. 190min
---------------	----------------

- The charging time indicated above is the time required when the battery is completely discharged. The time required for charging differs depending on conditions of battery usage. Charging takes longer when temperatures are either high or low and when the battery has not been used for a long period of time.

Remaining battery capacity

When using the camera, the remaining battery capacity is displayed.



Remaining capacity



(flashes red)

If the battery icon flashes red, recharge or replace the battery with a fully charged one.

- Use only the Leica battery BP-DC15 (→13).
- Leica Camera AG cannot guarantee the quality of any other type of battery.
- **Remove the battery from the camera after use.**
 - Keep the battery in a plastic case, making sure that it is kept away from metallic objects (such as clips) when carrying or storing it.
- To remove the battery, turn the camera off and wait until the Leica logo on the monitor goes off. (Failure to wait may cause the camera to malfunction and may damage the card or the recorded data.)

Guidelines for the number of recordable pictures and the operating time

Recording still pictures (When using the monitor)

Number of recordable pictures	approx. 350/300* pictures	By CIPA standard
Recording time	approx. 175/150* min	

Recording still pictures (When using the viewfinder)

Number of recordable pictures	approx. 320/270* pictures	By CIPA standard
Recording time	approx. 160/135* min	

* When the supplied flash unit is used.

Recording conditions by CIPA standard

CIPA is an abbreviation of "Camera & Imaging Products Association".

- [Program AE] Mode
- Temperature: 23°C (73.4°F)/Humidity: 50% RH when monitor is on.
- Using an SDHC memory card.
- Using the supplied battery.
- Starting recording 30 seconds after the camera is turned on (when [Stabilizer] is set to [(⏏)]).
- Recording once every 30 seconds with full flash output every second recording.
- Zooming through the complete focal length range (from Tele to Wide) or vice versa in every recording.
- Turning the camera off every 10 recordings and leaving it until the temperature of the battery decreases.

The number is reduced if intervals are longer (e.g. to approx. one quarter for 2-minute intervals under the above conditions).

Recording motion pictures (When using the monitor)

[Rec Quality]	Available recording time	Actual available recording time*1
[FHD/20M/30p]*2	approx. 135min	approx. 65min
[FHD/20M/25p]*3		
[4K/100M/30p]*2	approx. 90min	approx. 45min
[4K/100M/25p]*3		

*1 The time you can actually record when repeatedly turning the camera on and off, starting and stopping recording and using the lens' zoom function.

*2 With camera models 18 471 / 18 472

*3 With camera models 18 470 / 18 473

■ Recording conditions

- Temperature 23°C (73.4°F), humidity 50% RH
- Motion pictures with their file size set to [FHD], [HD] or [VGA] in [Rec Quality]:
Recording stops when the continuous recording time exceeds 29 minutes or the file size exceeds 4GB.
 - Since the file size becomes larger with [FHD], recording with [FHD] will stop earlier than after 29 minutes.
- Motion pictures with their file size set to [4K] in [Rec Quality]:
Recording stops when the continuous recording time exceeds 15 minutes. (You can continue recording without interruption even if the file size exceeds 4GB, but the video will be saved and played back in separate parts.)

Viewing pictures (When using the monitor)

Playback time	approx. 260min
---------------	----------------

● The operating times and number of recordable pictures will differ according to the environment and the operating conditions.

For example, in the following cases, the operating times shorten and the number of recordable pictures is reduced.

- In low-temperature environments, such as on ski slopes.
- When functions such as flash and zooming are used repeatedly.
- If the available battery capacity is significantly reduced, it is reaching the end of its lifespan. Please purchase a new battery.

Inserting and Removing the Battery / the Card

- Make sure that the camera is turned off.

1 Move the release slider to the [OPEN] position and open the card/battery door

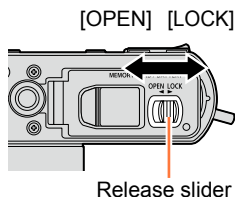

2 Insert the battery and card, making sure that their orientation is correct

- **Battery:**
Push it down until the latch locks the battery in its correct position.
- **Card:**
Push it down until it clicks into place.

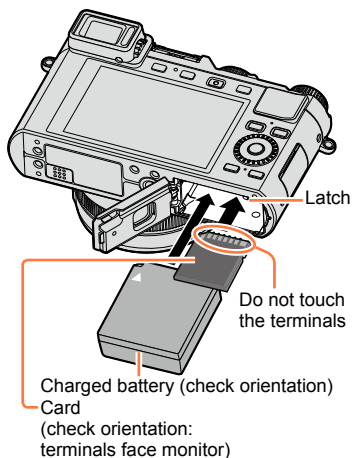

3 Close the card/battery door and move the release slider to the [LOCK] position

■ To remove

- **Battery:**
Move the latch in the direction of the arrow.

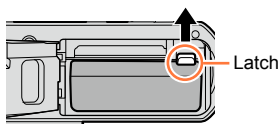

- **Card:**
Push it further down until it clicks, then pull it straight out.

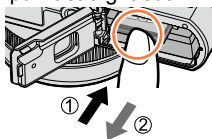

- Remove the battery from the camera after use.
- Keep the memory card out of reach of children to prevent swallowing.
- To remove card or battery, turn the camera off and wait until the Leica logo on the monitor turns off. (Failure to wait may cause the camera to malfunction and may damage the card or the recorded data.)

About Cards That can be Used

The following SD standard-based cards can be used.

Type of Card	Capacity	Notes
SD memory cards	8 MB – 2 GB	<ul style="list-style-type: none"> • Can be used with devices compatible with the respective formats. • Before using SDXC memory cards, check that your computer and other devices support this type of card. • This camera is compatible with UHS-I UHS Speed Class 3 standard SDHC/SDXC memory cards. • Only the cards listed on the left with the given capacities are supported.
SDHC memory cards	4 GB – 32 GB	
SDXC memory cards	48 GB, 64 GB	

■ About motion picture recording and speed class

According to the [Rec Quality] (→185) of a motion picture, the required card differs. Use a card that meets the following ratings of the SD or UHS speed classes.

- SD and UHS speed classes are the speed standards regarding continuous writing. Confirm the SD speed by checking the card label or other card related materials.

[Rec Quality]	Speed class	Label example
FHD/HD/VGA	Class 4 or higher	CLASS 4 4
4K	UHS speed class 3	U3

Access to the card

The access indication is displayed in red when pictures are being recorded on the card.



- While the camera is accessing the card (for an operation such as picture writing, reading, deletion, or formatting), do not turn it off or remove the battery or the card. Do not subject the camera to vibrations, impact, or static electricity. The card or the data on the card may be damaged, and the camera may no longer operate normally. If an operation fails due to vibration, impact or static electricity, perform it again.

About Cards That can be Used

- If you set the write-protect switch to “LOCK”, you may not be able to write, delete or format the data or display it by recording date. These operations become available again when you unlock the switch.
- It is recommended that you copy important recordings to your computer (as electromagnetic fields, static electricity, or faults may damage the data).



Formatting the card (initialization)

Format the card before recording a picture with the camera. **Since data cannot be recovered after formatting, make sure to back up necessary data in advance.**

1 Set the menu item

MENU → **X** [Setup] → [Format]

- A confirmation screen is displayed. If you select [Yes], the operation is executed.

- This requires a sufficiently charged battery.
- Do not turn off the camera or perform other operations during formatting.
- Always format cards with this camera. Please reformat the card with this camera if it has already been formatted with a computer or another device.
- If the card cannot be formatted, please try another card before contacting a Leica Camera AG service facility.

Recording capacity guidelines (pictures/recording time)

The number of pictures you can take and the recording time vary depending on card capacity (and on recording conditions and the type of card).

Recording picture capacity (still pictures)

When the aspect ratio is set to [4:3] and [Quality] is set to [FINE]

[Picture Size]	8GB	16GB	32GB	64GB
L (12.5M)	1090	2200	4420	8820
<input checked="" type="checkbox"/> M (6.5M)	1880	3810	7630	14970
<input checked="" type="checkbox"/> S (3M)	3220	6500	13030	24700

When the aspect ratio is set to [4:3] and [Quality] is set to [RAW FINE]

[Picture Size]	8GB	16GB	32GB	64GB
L (12.5M)	340	700	1400	2800
M (6.5M)	400	810	1620	3230
S (3M)	440	890	1780	3530

- When the number of recordable pictures exceeds 9,999, "9999+" is displayed.

About Cards That can be Used

Recording time capacity (motion pictures)

- The recordable time is the total time of all the motion pictures which have been recorded.

([h], [m] and [s] indicate “hours”, “minutes” and “seconds”.)

[Rec Quality]	8GB	16GB	32GB	64GB
[4K/100M/30p]*1 [4K/100M/25p]*2	9m 00s	20m 00s	42m 00s	1h 20m 00s
[4K/100M/24p]	9m 00s	20m 00s	42m 00s	1h 20m 00s
[FHD/28M/60p]*1 [FHD/28M/50p]*2	37m 00s	1h 15m 00s	2h 30m 00s	5h 00m 00s
[FHD/20M/30p]*1 [FHD/20M/25p]*2	49m 00s	1h 40m 00s	3h 20m 00s	6h 40m 00s
[HD/10M/30p]*1 [HD/10M/25p]*2	1h 30m 00s	3h 10m 00s	6h 25m 00s	12h 50m 00s
[VGA/4M/30p]*1 [VGA/4M/25p]*2	3h 25m 00s	7h 00m 00s	14h 10m 00s	28h 15m 00s

*1 With camera models 18 471 / 18 472

*2 With camera models 18 470 / 18 473

- If the surrounding temperature is high, or a motion picture is recorded continuously, [△] is displayed and recording may be stopped automatically to protect the camera.
- Motion pictures with their file size set to [FHD], [HD] or [VGA] in [Rec Quality]:
Recording stops when the continuous recording time exceeds 29 minutes or the file size exceeds 4GB.
 - Since the file size becomes larger with [FHD], recording with [FHD] will stop earlier than after 29 minutes.
- Motion pictures with their file size set to [4K] in [Rec Quality]:
Recording stops when the continuous recording time exceeds 15 minutes. (You can continue recording without interruption even if the file size exceeds 4GB, but the video will be saved and played back in separate parts.)
- **The maximum available continuous recording time is displayed on the screen.**



Switching the display between the number of recordable pictures and the available recording time

MENU → **⌘** [Custom] → [Remaining Disp.]

[📷] (Remaining shots):

Displays the number of pictures that can be recorded.

[🕒] (Remaining time):

Displays the remaining recording time.



Number of
recordable
pictures

Available
recording time

Setting Language, Time, and Date

The clock is not set when the camera is shipped.



- 1 Turn the camera on.**
- 2 Press [MENU/SET] while the message is displayed.**
- 3 Press ▲▼ to select the language, and then [MENU/SET].**
 - The [Please set the clock] message appears.
- 4 Press [MENU/SET].**
- 5 Press ◀▶ to select the items (year, month, day, hour, minute), and then ▲▼ to set.**

• To cancel → Press [↵/↶].

To set the display order or time display format:

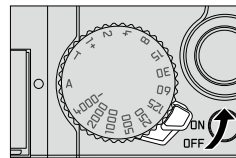
- Select [Style], and then press [MENU/SET] to display the setting screen for display order and time display format.



: Home time
: Destination time

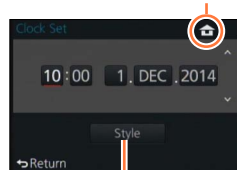

Style

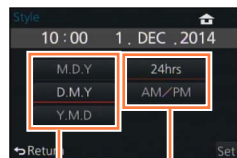

Display order

Time display format

- 6 Press [MENU/SET].**
 - A confirmation screen is displayed. Press [MENU/SET].
- 7 When [Please set the home area] is displayed, press [MENU/SET].**

Setting Language, Time, and Date

- 8** Press ◀▶ to set your home area, and then [MENU/SET].



Difference from GMT
(Greenwich Mean Time)

- If the clock is not set, the correct date cannot be printed when you order a photo studio to print the picture, or when you stamp the date on the pictures with [Text Stamp].

Changing time settings

Select [Clock Set] from the [Setup] menu to change the current time settings.

- Clock settings will be saved for approx. 3 months even after the battery is removed, provided a fully charged battery was installed in the camera for 24 hours beforehand.

1 Select [Clock Set] from the [Setup] menu.

- For details about how to set the menu: (→31)

2 Set the date and time (Perform steps 5 - 6. (→29))

Menu Control

You can use the menu to set camera and recording functions, operate playback functions, and perform other operations. In particular, the [Setup] menu contains some important settings relating to the camera's clock and power. Check the settings of this menu before proceeding to use the camera.



- When [Menu Resume] (→49) in the [Setup] menu is set to [ON], the screen displayed last after you selected the menu item will reappear. It is set to [ON] at the time of purchase.
- When [Menu Information] (→49) in the [Setup] menu is set to [ON], descriptions of the menu items and settings will appear on the menu screen.

Example: To change the [Quality] setting from [3:2] to [4:3] in the [Rec] menu

In these instructions, steps for setting a menu item are described as follows:

MENU → [Rec] → [Quality] → [4:3]

1 Press [MENU/SET] to bring up the menu.

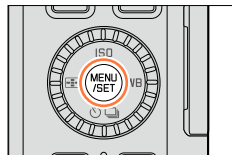

[Rec] (→273 -)	This menu lets you set the aspect ratio, the resolution and other aspects of the pictures you are recording.
[Motion Picture] (→275)	This menu lets you set the [Rec Quality], and other aspects for motion picture recording.
[Custom] (→276 -)	Operation of the camera, such as displaying of the screen and button operations, can be set up according to your preferences. Also, it is possible to register the modified settings.
[Setup] (→278)	This menu lets you perform the clock settings, select the operating beep tone settings and set other settings which make it easier for you to operate the camera. You can also configure the settings of Wi-Fi related functions.
[Playback] (→279)	This menu lets you set the Protection, Cropping or Print Settings, etc. of recorded pictures.

Menu Control

2 Press ▲▼ to select the menu item, and then [MENU/SET].

- Items can also be selected by turning the control dial.
- You can also switch to the next page by pressing [DISP] or rotating the zoom lever.



Item

3 Press ▲▼ to select the setting, and then [MENU/SET].

- Items can also be selected by turning the control dial.



Settings

4 Press [↵/⏏] repeatedly until the recording or playback screen reappears.

- During recording, the menu screen can also be exited by pressing the shutter button halfway.

Switching menu type

Example: Switching to the [Setup] menu from [Rec] menu

- 1 Press **◀**.
- 2 Press **▲▼** to select a menu switch icon [**X**].
 - Items can also be selected by turning the control dial.
- 3 Press **[MENU/SET]**.
 - Select the menu item and perform the setting.



Menu type

- The menu types and items that are displayed vary according to the mode.
- The setting methods vary depending on the menu item.

Setting the menu screen background

You can set the background for the menu screen according to your preferences.

- 1 **Set the menu item:**

[MENU] → **X** [**Setup**] → [**Menu Background**]
- 2 Press **▲▼** to select the background color, and then **[MENU/SET]**.
 - Exit the menu after it is set.

The Quick Menu

You can easily call some of the menu items and set them.

- The menu items and setting items that are displayed differ depending on the recording mode and settings during recording.

1 Press [QM] to display the Quick menu.

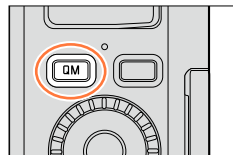

2 Turn the control dial to select the menu item, and then press ▼ or ▲.

- The menu item can also be selected by pressing ◀▶.

3 Turn the control dial to select the setting.

- The setting can also be selected with ◀▶.

4 Press [QM] button to close the Quick menu.



Switching the method for setting Quick Menu items

MENU → **C** [Custom] → **[Q.MENU]**

[PRESET]: The default items can be set.

[CUSTOM]: The Quick Menu will consist of the items you previously set. (→35)

Using the Quick menu on the monitor recording information screen (→62) of [] (monitor style)

(Press [DISP] repeatedly until the screen appears.)

Press [QM], turn the control dial to select an item, and then press [MENU/SET].

Turn the control dial to select the setting, and then press [MENU/SET] to set.

- You can also set with ▲▼◀▶ and [MENU/SET].



Customizing the Quick Menu

When [Q.MENU] (→34) in the [Custom] menu is set to [CUSTOM], the Quick Menu can be changed as desired. Up to 15 items can be assigned to the Quick Menu.

1 Press **▼** to select [**Q**], and then [MENU/SET].

2 Press **▲▼◀▶** to select the menu item in the top row, and then [MENU/SET].

3 Press **◀▶** to select the empty space in the bottom row, and then [MENU/SET].

- If there is no empty space in the bottom row, you can replace an existing item with a new one by selecting the existing item.
- To cancel the setting, move to the bottom row by pressing **▼**, select an item to cancel, and then press [MENU/SET].
- Items that can be assigned are as follows:



Items that can be setup as Quick Menus

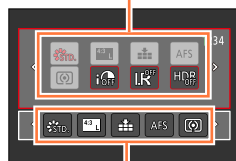

Items that can be displayed in the Quick Menu screen

[Rec] menu/Recording functions

- | | |
|--------------------------|--------------------------|
| • [Photo Style] (→100) | • [Flash Mode] (→181) |
| • [Picture Size] (→108) | • [Flash Adjust.] (→184) |
| • [Quality] (→109) | • [i.Zoom] (→173) |
| • [AFS/AFF/AFC] (→114) | • [Digital Zoom] (→174) |
| • [Metering Mode] (→139) | • [Stabilizer] (→169) |
| • [i.Dynamic] (→111) | • [Sensitivity] (→136) |
| • [i.Resolution] (→111) | • [White Balance] (→103) |
| • [HDR] (→112) | • [AF Mode] (→115) |
| • [Shutter Type] (→140) | • [Drive Mode] (→141) |

[Motion Picture] menu

- | | |
|----------------------------|-------------------------|
| • [4K PHOTO] (→192) | • [Picture Mode] (→195) |
| • [Motion Pic. Set] (→185) | |

The Quick Menu

[Custom] menu

- | | |
|--|--|
| <ul style="list-style-type: none">• [Silent Mode] (→162)• [Peaking] (→130)• [Histogram] (→64)• [Guide Line] (→65) | <ul style="list-style-type: none">• [Zebra Pattern] (→167)• [Monochrome Live View] (→168)• [Rec Area] (→189)• [Zoom lever] (→176) |
|--|--|

4 Press [↶/↷].

- This will return the screen to that of step **1** (→35). Press [MENU/SET] to switch to the recording screen.

Assigning Frequently Used Functions to the Function Buttons

To allow immediate access to them, you can assign a number of functions to particular buttons.

1 Set the menu item:

MENU → **⌘ [Custom]** → **[Fn Button Set]**

2 Press ▲ ▼ to select the function button you want to assign a function to, and then [MENU/SET].

3 Press ▲ ▼ to select the function you want to assign, and then [MENU/SET].

- For details on the functions that can be assigned, refer to (→38).
- To restore the default function button settings, select [Restore to Default].

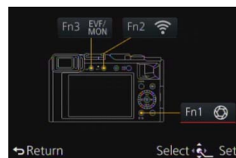

Assigning Frequently Used Functions to the Function Buttons

Assigning a function to a function button

Press the function button to use the assigned function.

- You can assign the following functions to the [Fn1], [Fn2], and [Fn3] buttons.

[Rec] menu/Recording functions

- | | | |
|--------------------------------------|-----------------------------|--------------------------|
| • [Wi-Fi] (→222): [Fn2]* | • [Picture Size] (→108) | • [Flash Adjust.] (→184) |
| • [EVF/Monitor Switch] (→55): [Fn3]* | • [Quality] (→109) | • [i.Zoom] (→173) |
| • [AF/AE Lock] (→133) | • [AFS/AFF/AFC] (→114) | • [Digital Zoom] (→174) |
| • [AF-ON] (→129, 133) | • [Metering Mode] (→139) | • [Stabilizer] (→169) |
| • [Preview] (→88): [Fn1]* | • [Highlight Shadow] (→102) | • [Sensitivity] (→136) |
| • [Level Gauge] (→66) | • [i.Dynamic] (→111) | • [White Balance] (→103) |
| • [Focus Area Set] | • [i.Resolution] (→111) | • [AF Mode/MF] (→115) |
| • [Cursor Button Lock] | • [HDR] (→112) | • [Drive Mode] (→141) |
| • [Photo Style] (→100) | • [Shutter Type] (→140) | • [Restore to Default] |
| | • [Flash Mode] (→181) | |

[Motion Picture] menu

- | | |
|----------------------------|-------------------------|
| • [4K PHOTO] (→192) | • [Picture Mode] (→195) |
| • [Motion Pic. Set] (→185) | |

[Custom] menu

- | | | |
|--------------------------------------|---------------------------------|-----------------------|
| • [Utilize Custom Set feature] (→60) | • [Guide Line] (→65) | • [Rec Area] (→189) |
| • [Silent Mode] (→162) | • [Zebra Pattern] (→167) | • [Zoom lever] (→176) |
| • [Peaking] (→130) | • [Monochrome Live View] (→168) | |
| • [Histogram] (→64) | | |

* Function button settings at the time of purchase.

- Certain functions cannot be assigned to some function buttons.

- The function assigned to the function button may not work in some modes or on some display screens.
- When [Focus Area Set] is assigned to a function button, you can display the AF area or the MF Assist position setting screen.
- When the cursor button is locked, operation of the cursor button, the [MENU/SET] button, and the control dial is disabled. To enable operation, press the function button again.





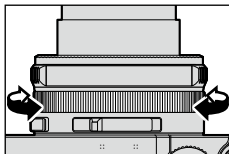

- The function assigned to the [Fn1] button will not work in the following cases:
 - When the picture effect (Filter) is set to ([Miniature Effect], [One Point Color], [Sunshine])
 - When [Multi Exp.] is set
- The function assigned to the [Fn2] button will not work in the following cases:
 - When using [Time Lapse Shot]
 - When recording 4K motion pictures after setting [4K PHOTO] to [ON]

Changing Settings Using the Control Ring

The control ring allows easy and convenient settings of several functions.



Items that can be set with the control ring vary depending on the recording modes. Following are the pre-assigned settings.

Recording mode	Setting
A [Snapshot Mode]	 Step Zoom (→175)
P [Program AE] Mode	 Step Zoom (→175)
A [Aperture-Priority] Mode	 Step Zoom (→175)
S [Shutter-Priority] Mode	 Shutter speed adjustment*(→84)
M [Manual Exposure] Mode	 Shutter speed adjustment*(→86)

* You can use the control ring to change the following settings, which cannot be set using the shutter speed dial.

- Faster shutter speeds than 1/4000s (electronic shutter (→140))
- Slower shutter speeds than 1s (mechanical shutter (→140))
- Setting in 1/3 EV steps

- The control ring is assigned to selecting the picture effect (Filter) when you are recording a panorama picture. (→150)
- When Manual Focus is set, focusing is assigned to the control ring. (→128)
- The control ring can be used to change to your preferred settings. (→40)

Changing the settings assigned to the control ring

To change the settings assigned to the control ring.

1 Set the menu item:

MENU → **/C [Custom]** → **[Control Ring]**

2 Use **▲ ▼** to select the setting, and then press **[MENU/SET]**.

Settings that can be assigned
[DEFLT] [Normal]
Q [Zoom] (→171)
Q. [Step Zoom] (→175)
ISO [Sensitivity] (→136)
WB [White Balance] (→103)
Ⓕ [Filter Select] (→89)
[OFF] [Not Set]

- To return to the default setting, select [Normal]. (→39)
- If you do not want to use the control ring, select [OFF] ([Not Set]).

- The assigned function setting applies to all recording modes. The function assigned to the control ring may not work in some recording mode combinations or settings used for recording (panorama picture recording, Filter setting, etc.)
- When Manual Focus is set, the control ring's function is limited to focusing. You cannot use the settings assigned using [Control Ring]. (→128)

The [Setup] Menu

[Clock Set] and [Sleep Mode] are important. Please check these before use.
For details on how to select the [Setup] menu settings, refer to (→31)

[Clock Set]

For setting time, date, and display format: (→30)

[World Time]

For setting the recording date and time with the local time at your destination.

- Set [Home] when you use the camera for the first time after purchasing it. You can set [Destination] after setting [Home].

Settings: [Destination] / [Home]

- 1 Use ▲ ▼ to select [Destination] or [Home], and then press [MENU/SET].
- 2 Use ◀ ▶ to select area, and then press [MENU/SET].



■ To set daylight savings time

Press ▲ in step 2. (Press again to release the setting.)

- When daylight savings time [☀️] is set, the current time is advanced by 1 hour. If the setting is canceled, the time automatically returns to the current time.

■ When you come back from your travel destination

Select [Home] in step 1, and then press [MENU/SET].

- If you cannot find your destination in the region highlighted on the screen, set based on the difference to your home time.

For details on how to select the [Setup] menu settings, refer to (→31)

[Travel Date]

If you set your travel schedule and record pictures, the day of your trip on which the picture was taken will be recorded.

■ [Travel Setup]

Settings: [SET] / [OFF]

- 1 Use ▲ ▼ to select [Travel Setup], and then press [MENU/SET].
- 2 Use ▲ ▼ to select [SET], and then press [MENU/SET].
- 3 Use ▲ ▼ ◀▶ to select the departure date, and then press [MENU/SET].
- 4 Use ▲ ▼ ◀▶ to select the return date, and then press [MENU/SET].

■ To record [Location]

Once the [Travel Setup] is set, you can also set the location.

- ① Select [Location] in step 1 above, and then press [MENU/SET].
- ② Use ▲ ▼ to select [SET], and then press [MENU/SET].
- ③ Enter your location. (Entering text (→52))

- To print [Location] or the number of days that have passed, use [Text Stamp].
- The travel date is calculated from the set departure date and the date set in the camera's clock. When destination is set in [World Time], the days elapsed are calculated based on the local destination time.
- When [Travel Setup] is set to [OFF], the number of days elapsed is not recorded. It is not displayed even if [Travel Setup] is set to [SET] after recording.
- When the current date passes the return date, [Travel Setup] is automatically canceled.
- [Location] is not recorded when you record motion pictures.

[Wi-Fi]

Settings: [Wi-Fi Function] / [Wi-Fi Setup]

For configuring the settings required for the Wi-Fi function. (→224, 247)

For details on how to select the [Setup] menu settings, refer to (→31)

[Beep]

For setting the beep or shutter sounds.

■ [Beep Volume]

Settings: (High) / (Low) / (Off)

■ [Shutter Vol.]

Settings: (High) / (Low) / (Off)

■ [Shutter Tone]

Settings: ① / ② / ③

- When [Silent Mode] is set to [ON], [Beep Volume] and [Shutter Vol.] are set to “Off”.

[Live View Mode]

Sets the display refresh rate and picture quality of the screen (Live View screen) when recording pictures.

Settings

[30fps]	Picture quality has higher priority over display refresh rate and; pictures are displayed at 30 fps. For example, use this mode when you want to record a comparatively slow-moving subject while confirming the focusing. It minimizes power consumption, thus extending the operating time.
[60fps]	The display refresh rate has higher priority over picture quality and; pictures are displayed at 60 fps. The displayed pictures will appear slightly grainy. For example, use this mode when you want to record a fast-moving subject.

- The [Live View Mode] setting does not affect the recorded picture.
- The display refresh rate may slow down in dark locations.
- When the viewfinder is used, [Live View Mode] is fixed to [60fps].





For details on how to select the [Setup] menu settings, refer to (→31)

[Monitor Display] / [Viewfinder]

For adjusting brightness and color of the monitor and viewfinder images. It is suggested to use the default settings.

These are intended to provide a preview of the actual picture as accurately as possible.

Settings

 [Brightness]	For adjusting the brightness.
 [Contrast]	For adjusting the contrast.
 [Saturation]	For adjusting the vividness of colors.
 [Red Tint]	For adjusting the rendition of red.
 [Blue Tint]	For adjusting blue.

1 Press ▲ ▼ to select the setting item, and then ◀ ▶ to make adjustments.

- You can also make adjustments with the control dial.

2 Press [MENU/SET].





- The settings will affect the monitor image when it is in use, and the viewfinder's when it is in use.
- Some subjects may look different than in reality, but the recorded picture will not be affected.





For details on how to select the [Setup] menu settings, refer to (→31)

[Monitor Luminance]

For setting the monitor brightness according to the ambient light level.

Settings

	The brightness is adjusted automatically depending on how bright it is around the camera.
	The brightness is increased.
	The brightness is standard.
	The brightness is decreased.

- Because the picture shown on the monitor screen emphasizes brightness, some subjects may look different than in reality, but this will not affect the recorded picture.
- [] returns to ordinary brightness if there is no operation for 30 seconds when recording. (Press any button to make the screen brighter again.)
- Setting [] or [] reduces the operating time.
- [] cannot be selected during playback.

For details on how to select the [Setup] menu settings, refer to (→31)

[Sleep Mode]

The camera is automatically turned off after not being used for the preset time.

- To restore → Press the shutter button halfway, or turn on the camera again.

Settings: [10MIN.] / [5MIN.] / [2MIN.] / [1MIN.] / [OFF]



The function is not available in the following cases:



- During motion picture recording/playback
- When [Multi Exp.] is set
- When connected to a computer/printer
- During slide shows
- When using [Time Lapse Shot]
- When using [Stop Motion Animation]

For details on how to select the [Setup] menu settings, refer to (→31)

[USB Mode]

For selecting the communication method when connecting the camera to a computer or printer with the supplied USB cable.

Settings

 [Select on connection]	Selects the communication method each time you connect to a computer or PictBridge-compatible printer.
 [PictBridge(PTP)]	Is selected when connecting to a PictBridge-compatible printer.
 [PC]	Is selected when connecting to a computer.

[TV Connection]

For changing the settings to be used when the camera is connected to a TV or another device.

■ [Video Out] (With camera models 18 470 / 18 473)

This setting is activated when the camera is connected via an AV or HDMI micro cable.

Settings

[NTSC]	Video output is set to the NTSC system.
[PAL]	Video output is set to the PAL system.

■ [TV Aspect]

This setting is activated when the camera is connected via an AV cable.

Settings: [16:9] / [4:3]

For details on how to select the [Setup] menu settings, refer to (→31)

[TV Connection] (continued)

■ [HDMI Mode]

For setting the format for the HDMI output when playing back on an HDMI-compatible high-definition TV connected with the camera using an HDMI micro cable.

Settings

[AUTO]	Automatically sets the output resolution based on information from the connected TV.
[4K]	Outputs pictures with a resolution of 3840×2160 pixels using the progressive scan method for 2,160 effective scanning lines.
[1080p]	Outputs pictures using the progressive scan method for 1,080 effective scanning lines.
[1080i]	Outputs pictures using the interlace scan method for 1,080 effective scanning lines.
[720p]	Outputs pictures using the progressive scan method for 720 effective scanning lines (720 lines).
[576p]*1/[480p]*2	Outputs pictures using the progressive scan method for 576*1/480*2 effective scanning lines.

*1 When [Video Out] is set to [PAL]

*2 When [Video Out] is set to [NTSC]

- This will work when an HDMI micro cable is connected.
- If no image appears on the TV with [AUTO], switch to a constant setting other than [AUTO] to set a format supported by your TV. (Please read the instructions for the TV.)

For details on how to select the [Setup] menu settings, refer to (→31)

[TV Connection] (continued)

■ [HDTV Link]

For enabling automatic linking with other HDTV Link-compatible devices, and operability with a HDTV remote control when connected via an HDMI micro cable. (→251)

Settings

[ON]	Operations may be performed via the remote control of the HDTV Link-compatible device. <ul style="list-style-type: none"> • Not all operations will be available. • Operability of the camera's own buttons will be limited.
[OFF]	Operations must be performed via the camera's own buttons.

- This will work when an HDMI micro cable is connected.

[Menu Resume]

For saving the last operated menu position.

Settings: [ON] / [OFF]

[Menu Background]

For setting the background color for the menu screen. (→33)

[Menu Information]

For displaying explanations of the menu items and settings on the menu screen.

Settings: [ON] / [OFF]

[Language]

For changing the display language.

Set the language displayed on the screen.

For details on how to select the [Setup] menu settings, refer to (→31)

[Version Disp.]

For checking the firmware version of the camera or the supplied flash unit (when it is attached).

- When you press [MENU/SET] while the version is displayed, software information, such as the license, is displayed.

[Self Timer Auto Off]

The self-timer is canceled if the camera is turned off.

Settings: [ON] / [OFF]

[No.Reset]

For resetting picture file numbers. (The folder number is updated and the file number starts from 0001.)

- To reset folder number to 100:

First, format the card, and reset the file numbers using [No.Reset]. Then, select [Yes] on the folder number reset screen.

- A folder number between 100 and 999 can be assigned.
Numbers cannot be reset once the folder number reaches 999. In this case, save all necessary pictures to your computer, and format the card (→26).

[Reset]

For resetting to the default settings.

■ [Reset Rec. settings?]

■ [Reset setup/custom settings?]

- Information registered in [Face Recog.] is reset if recording settings are reset.
- When the setup/custom settings are reset, the following settings are also reset:
 - The [Profile Setup] setting
 - The settings of [Rotate Disp.], [Picture Sort], [Delete Confirmation] in the [Playback] menu
- Folder numbers and clock settings will not be reset.

For details on how to select the [Setup] menu settings, refer to (→31)

[Reset Wi-Fi Settings]

For returning [Wi-Fi] settings to default settings.

- If you want to dispose or give away your camera, always reset it to prevent your personal information from being mistakenly used.
- When you have your camera repaired, backup your personal information and always reset it as well.

[Format]

For formatting (initializing) a memory card. (→26)

Entering Text

Use the cursor buttons to enter names with the Face Recognition function and in [Profile Setup] (babies and pets), or to register locations in [Travel Date] etc.

- Only alphabetical characters and symbols can be entered.
- Example of operation for displaying a screen:

MENU → [] → [Rec] → [Profile Setup] → [SET] → [Baby1] → [Name] → [SET]

1 Use ▲▼◀▶ to select characters.

2 Press [MENU/SET] several times until the desired character is displayed.

Cursor position

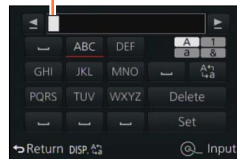

Text is inserted at the cursor position.

- []: Enter a blank.

■ To change the character type

- Press [DISP].
- Use ▲▼◀▶ to select [], and then press [MENU/SET].

■ To continue entering characters

- Use ▲▼◀▶ to select [], and then press [MENU/SET].
- Move the zoom lever toward T side.
- Turn the control dial to the right.

■ Editing text

- ① Use ▲▼◀▶ to select [] [], and then press [MENU/SET]. Then, move the cursor to the text to edit.
 - You can also use the zoom lever or control dial to reposition the cursor.
- ② Use ▲▼◀▶ to select [Delete], and then press [MENU/SET].
- ③ Use ▲▼◀▶ to select the correct text, and then press [MENU/SET].

3 When you are finished entering text, use ▲▼◀▶ to select [Set], and then press [MENU/SET].

- A maximum of 30 characters can be entered (a maximum of 9 when setting names in [Face Recog.]).
- A maximum of 15 characters can be entered for [\], [[], []], [•] and [-] (a maximum of 6 when setting names in [Face Recog.]).

How to Hold the Camera

- To avoid camera shake, hold it steady with both hands, keeping your arms close to your body while standing with your feet slightly apart.
 - Do not touch the lens barrel.
 - Do not cover the microphone when recording motion pictures.
 - Do not cover the AF Assist Lamp or the flash when you take a picture using them. Do not look at them from close range.
 - Make sure not to move the camera when you press the shutter button.
- **We recommend using the supplied carrying strap to avoid dropping the camera.**

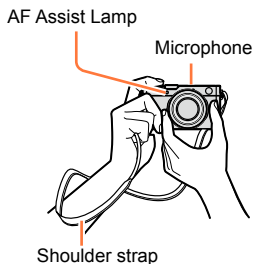

About the direction detect function

Still pictures recorded with the camera held vertically can be automatically displayed in portrait orientation during playback. (Only when [Rotate Disp.] is set to [ON].)

- The direction detect function may not operate correctly if pictures are taken with the camera pointing up or down.
- Motion pictures cannot be displayed in portrait orientation.

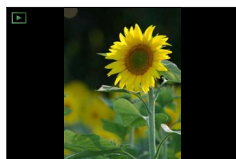

Using the Viewfinder

The viewfinder provides an excellent view of the subject even if you are in a bright area.

Switching between monitor and viewfinder

The [EVF]/Fn3 button operates in two ways:
Use it either as [EVF] or as a function button.
At the time of purchase, the button is assigned to [EVF].
• For details on the function buttons, refer to (→37).

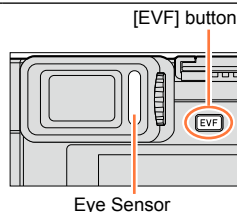

1 Press [EVF].

- The display is switched as shown below.

**Automatic switching
between viewfinder and
monitor**

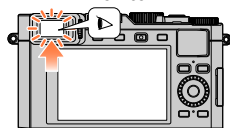

Viewfinder display

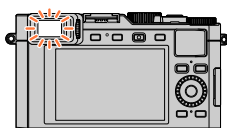

Monitor display

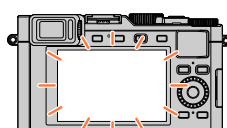

Automatic switching between viewfinder and monitor

The eye sensor automatically switches to the viewfinder display when your eye or an object moves close to it, and to the monitor display if not.

- The eye sensor may not work correctly depending on the shape of your eyeglasses, the way you hold the camera, or whether the eyepiece and nearby areas are exposed to strong light. In this case, press [EVF] to switch displays.
- During motion picture playback or Slide Show, the eye sensor will not automatically switch the display to the viewfinder.
- The sensitivity of the eye sensor can be set using [Eye Sensor] in the [Custom] menu. (→55)



Setting the sensitivity of the eye sensor or setting to switch between the viewfinder and monitor displays

MENU → **C** [Custom] → [Eye Sensor]

[Sensitivity]	Use this setting to set the sensitivity of the eye sensor. [HIGH] / [LOW]
[EVF/Monitor Switch]	Use this setting to switch between the viewfinder and monitor displays. [EVF/MON AUTO] (Automatic switching between viewfinder and monitor) / [EVF] (Viewfinder display) / [MON] (Monitor display) • After the display is switched using the [EVF] button, the setting of [EVF/Monitor Switch] will also change.

About diopter adjustment

Adjust the diopter to suit your vision so that you can see the viewfinder image with the best sharpness.

Turn the diopter adjustment wheel to adjust until you are able to clearly see the characters displayed in the viewfinder.

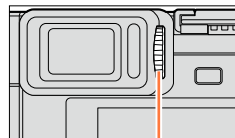

Diopter adjustment wheel

About Eye Sensor AF

If [Eye Sensor AF] in the [Custom] menu is set to [ON], the camera automatically focuses when the eye sensor is activated.

- Eye Sensor AF focuses only once, i.e. not continuously.

- Even when [Eye Sensor AF] is set and the camera automatically focuses, a beep will not sound.



The function may not work when the lighting is low.

Taking Still Pictures

- Press [] / () to set the drive mode to [] ([Single]).

1 Select the recording mode. (→59)

2 Press the shutter button halfway to focus.



- The aperture value and shutter speed are displayed. (They will flash in red if the correct exposure is not achieved, unless you are using a flash unit.)
- When you take a picture in a dark location, the focus indication displays [] and focusing may take longer than usual.
- When [AFS/AFF/AFC] in the [Rec] menu is set to [AFF] or [AFC]:
 - A beep sounds only the first time the camera is focused while you press the shutter button halfway.
 - When Auto Focus mode is set to Custom Multi, such as [] and [], the AF area will be momentarily displayed only for the first time when the camera is focused while you press the shutter button halfway.

Focus display

(When focusing is successful: illuminated
When focusing is not successful: flashing)

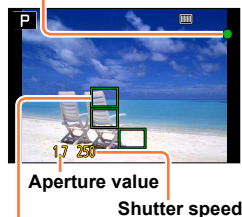

AF area frame

(When focusing is successful: green)

3 Press the shutter button fully down to take the picture.



- The focus display flashes and a beep sounds when focusing is not successful. Use the focus range displayed in red as a reference. Even if the focus display is lit, the camera may be unable to bring the subject into focus if it is out of range.
- The AF frame may be larger depending on recording conditions such as dark locations or the set focal length.
- The displayed image quality may be lower during Autofocus operation.

Focus display

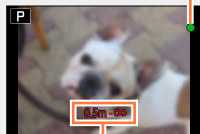

Focus range



- Subjects/environments which may make focusing difficult:
 - Fast-moving or extremely bright objects, or objects with no color contrast.
 - Taking pictures through glass or near objects emitting light.
 - In the dark, or with significant camera shake.
 - When too close to an object or when taking pictures of both distant and close objects together in the same picture.



Displaying still pictures immediately after taking them

MENU → **⌘C [Custom]** → **[Auto Review]**

[Duration Time]	For setting the time the pictures are displayed immediately after taking them. [HOLD] : Displays pictures until you press the shutter button halfway. [5SEC] / [4SEC] / [3SEC] / [2SEC] / [1SEC] / [OFF]
[Playback Operation Priority]	[ON] : During [Auto Review], you can switch the playback screen or delete pictures. [OFF] : During [Auto Review], you can perform the same button operations as when you take a picture.

- When [Duration Time] is set to [HOLD], [Playback Operation Priority] is fixed to [ON].

Recording Motion Pictures

Motion pictures, including those taken in 4K, are recorded in the MP4 format. (→191)
Audio is recorded in stereo.

1 Press the motion picture button to start recording.

- Immediately release the motion picture button after pressing it.
- You can record motion pictures in each recording mode. (→59)
- While recording motion pictures, the recording status indicator (red) will flash.
- If you do not perform any operation for approximately 1 minute or longer, some of the information on the screen is turned off. To display the information again, press [DISP].
- Do not cover the microphones when recording motion pictures.
- You can also change the lens' focal length (zoom) while recording motion pictures.
 - The operating sounds of the zoom lever or the control ring may be recorded in some cases.
- Still pictures can be taken during motion picture recording. (→195)

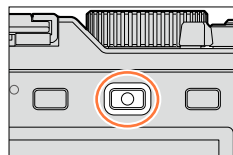

Recording state indicator

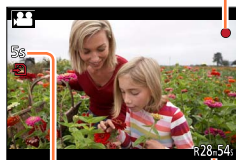

Elapsed recording time

Remaining recording time (approx.)

2 Press the motion picture button again to end recording.

- For details, read "Recording motion pictures". (→185)

Selecting the Recording Mode

To select the recording mode using the aperture ring and the shutter speed dial

1 Turn the aperture ring and the shutter speed dial.

- Make sure the aperture ring and the shutter speed dial click into place in the desired number or letter position.

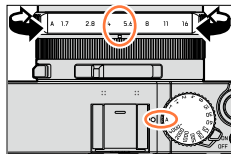

To select [Snapshot Mode]

1 Press [A].

- [Snapshot Mode] is set and the recording mode icon changes to [A]. When you press [A] again, the recording mode is switched to one that enables settings to be made using the aperture ring and shutter speed dial.
- When [Snapshot Mode] is selected, the recording mode that was set using the aperture ring and shutter speed dial is canceled.

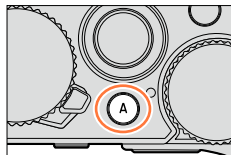

A [Snapshot Mode] (→75)

For taking pictures with extended automatic settings.



P Program Mode (→81)

For taking pictures with automatic exposure control.

A Aperture-Priority Mode (→83)

The exposure is determined by the automatically controlled shutter speed, based on the manually set aperture value.

S Shutter-Priority Mode (→84)

The exposure is determined by the automatically controlled aperture value, based on the manually set shutter speed.

M Manual Exposure Mode (→86)

The exposure is determined by the manually set aperture value and shutter speed.

Registering a combination of settings to be used during recording (Custom Set)

You can register up to three combinations of your preferred menu settings. Selecting [Utilize Custom Set feature] from the [Custom] menu enables you to switch quickly to the settings you selected for the custom settings.

■ Registering the custom set

- ① Set your preferred menu settings in the [Rec], [Motion Picture], and [Custom] menus.
- ② Set the menu item:

MENU → **/C [Custom]** → **[Cust.Set Mem.]**

- ③ Use ▲ ▼ to select custom set (C1-C3) for registration, and then press [MENU/SET].
 - A confirmation screen is displayed. If you select [Yes], the operation is executed.
- The following menu items can not be registered as custom settings.

[Rec] menu	[Setup] menu	[Playback] menu
<ul style="list-style-type: none"> • Data registered with [Face Recog.] • The [Profile Setup] setting 	<ul style="list-style-type: none"> • All menus 	<ul style="list-style-type: none"> • [Rotate Disp.] • [Picture Sort] • [Delete Confirmation]

■ Using custom settings

- ① Set the menu item:

MENU → **/C [Custom]** → **[Utilize Custom Set feature]**

- ② Use ▲ ▼ to select custom set.
- ③ Press [MENU/SET].
 - The settings are switched to those you selected for the custom set.



Using a function button to call up the custom settings

Assigning a function button to [Utilize Custom Set feature] allows you to switch quickly to your preferred settings by pressing the respective function button.

- ① Assign [Utilize Custom Set feature] to your preferred function button using [Fn Button Set] in the [Custom] menu. (→37)
- ② Press the function button to which [Utilize Custom Set feature] is assigned. Use ◀▶ to select custom set, and then press [MENU/SET].



When changing the menu settings

Even if the menu settings are changed temporarily while any one of the custom settings is selected, the currently registered settings will remain unchanged.

To change the currently registered settings, overwrite the registered data using [Cust.Set Mem.] in the [Custom] menu.



The function is not available in the [Snapshot Mode].

Switching Information Displayed on the Recording Screen

You can also turn off the recording information (such as icons for various settings) and the level gauge (→66).

1 Press [DISP] to switch the display.

- You can use [Monitor Disp. Style] and [EVF Disp. Style] in the [Custom] menu to select either [] (Monitor style display layout) or [] (Viewfinder style display layout) for the display screen of the monitor and viewfinder.

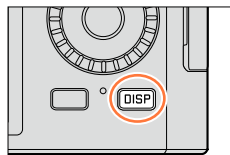

■ [] Monitor style display layout

- The display is switched as shown below. (Example)

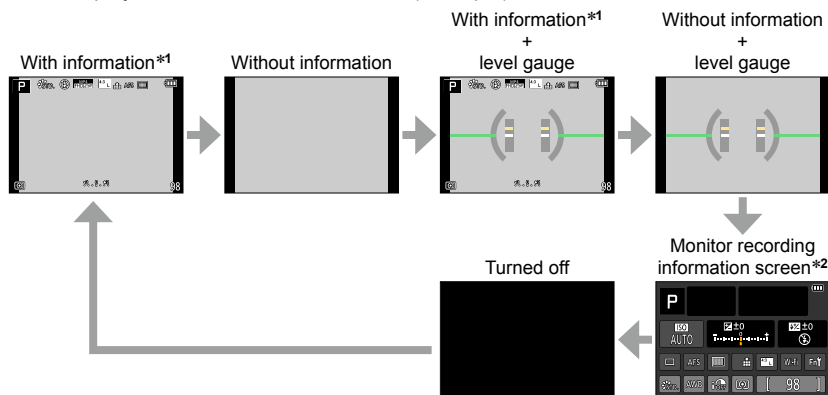

*1 When [Histogram] in the [Custom] menu is set to [ON], a histogram is displayed. (→64) When [Expo.Meter] in the [Custom] menu is set to [ON], the Shutter speed/aperture indication is displayed. (→81)

*2 This screen is displayed only when [Monitor Info. Disp.] in the [Custom] menu is set to [ON]. (→65) While you are checking the recording information on the monitor, you can use the viewfinder to record pictures.

Switching Information Displayed on the Recording Screen

■ [] Viewfinder style display layout

- The display is switched as shown below. (Example)

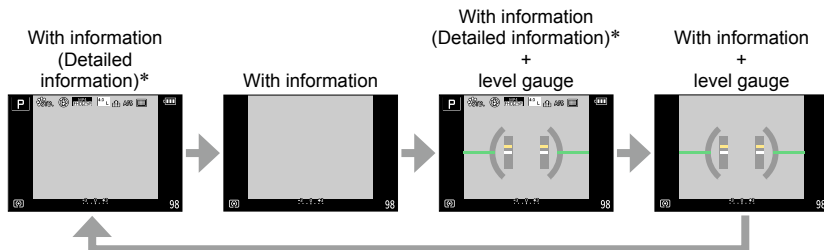



*When [Histogram] in the [Custom] menu is set to [ON], a histogram is displayed. (→64) When [Expo.Meter] in the [Custom] menu is set to [ON], the Shutter speed/aperture indication is displayed. (→81)

- If you do not perform any operation for approximately 1 minute or longer, some of the information on the screen is turned off. To display the information again, press [DISP].

Switching the monitor display method

MENU →  [Custom] → [Monitor Disp. Style]

: Viewfinder style display layout

: Monitor style display layout

Switching the viewfinder display method

MENU →  [Custom] → [EVF Disp.Style]

: Viewfinder style display layout

: Monitor style display layout

Switching Information Displayed on the Recording Screen



Enabling/disabling the histogram display

MENU → **f** [Custom] → [Histogram] → [ON] / [OFF]

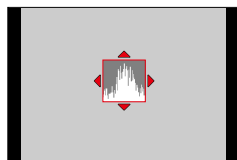
Use ▲ ▼ ◀ ▶ to set the position.

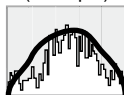

(Example)



Dark ← OK → Bright

A Histogram is a graph that displays brightness along the horizontal axis (black to white) and the number of pixels at each brightness level on the vertical axis. A peak in the center represents correct brightness (correct exposure). This can be used as a reference for exposure compensation, etc.

- When the histogram is not the same as that of the recorded picture under the following conditions, it will be displayed in orange:
 - When the light balance indicates settings other than 0 EV in [Manual Exposure] Mode or during exposure compensation.
 - When the flash fires.
 - When the correct exposure is not achieved or when the brightness of the screen cannot be displayed accurately in a dark location.
- The histogram displayed during recording is only a reference.
- The histogram is different from those displayed using the image editing software of a computer.

Switching Information Displayed on the Recording Screen

 **Enabling/disabling the guideline display**

MENU →  [Custom] → [Guide Line] →  /  /  / [OFF]

- The guideline display is not available during panorama picture recording.

When you select , you can use ▲ ▼ ◀ ▶ to set the position.

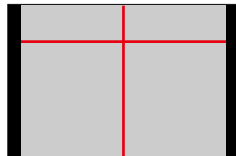
 **Turning on/off the recording information screen of the monitor**

MENU →  [Custom] → [Monitor Info. Disp.] → [ON] / [OFF]

Switching Information Displayed on the Recording Screen

Using the level gauge

If you want to make sure that the camera is not slanted or tilted, for example, when you take a picture of a landscape, use the level gauge indication as a reference.

1 Press [DISP] to switch the display.

Press the button to switch the display until the level gauge is displayed.

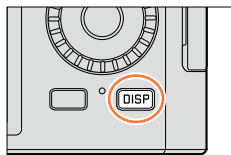
2 Correct the camera position.**■ Using the level gauge**

The yellow line indicates the current angle. Correct the angle of the camera so that it matches the white line.

Tilting up or down

- In this case, it is facing upward.

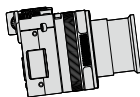
**Tilting left or right**

- In this case, the right side is lower.

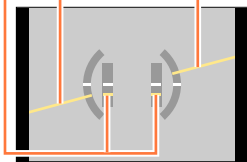
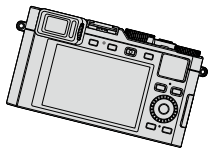

- When the camera is tilted very little or not at all, the level gauge will turn green.
- When pictures are taken in portrait orientation, the level gauge is automatically switched to that orientation.

- Even when the camera position is more or less correct, there may be an error of about ± 1 degree.
- When [Level Gauge] is assigned to a function button, you can turn the level gauge on and off by pressing that function button.



The function is not available in the following cases:

- When the camera is being moved, the level gauge may not be displayed correctly.
- The level gauge may not be displayed correctly or the direction detect function (\rightarrow 53) may not operate correctly if the pictures are taken with the camera pointing steeply up or down.

Viewing Your Pictures

1 Press [▶].

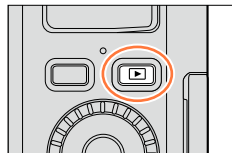

2 Press ◀▶ or turn the control dial to select the picture to be displayed.

- When you press and hold ◀▶, the pictures are displayed one after another.
- The playback speed of pictures varies depending on the playback conditions.



Ending Playback

Press [▶] again or press the Motion picture button.

The Playback can also be ended by pressing the shutter button halfway.

- When the camera is switched to playback, the lens barrel is retracted after approx. 15 seconds.



The function is not available in the following cases:

- This camera is compliant with the unified DCF (Design rule for Camera File system) standard formulated by the Japan Electronics and Information Technology Industries Association (JEITA), and with Exif (Exchangeable image file format). Files that are not DCF-compliant cannot be played back.
- It may not be possible to properly play back pictures taken using other cameras on this one or it may not be possible to use this camera's functions for those pictures.

Zooming in and viewing “Playback Zoom”

1 Turn the zoom lever in the T direction.

- Each time you turn the zoom lever in the T direction, the magnification increases through four levels: 2x, 4x, 8x, and 16x. (The picture quality displayed becomes successively lower.)
- To reduce the magnification ratio → Turn the zoom lever in the W direction.
- To move the position of the displayed section → Press ▲▼◀▶.

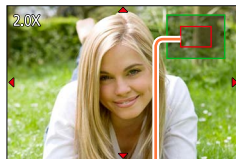
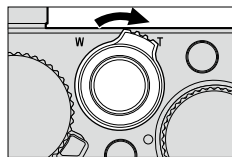

Current zoom position

- Playback zoom cannot be used during motion picture playback, automatic scrolling playback of panorama pictures or continuous playback.

Viewing a list of pictures “Multi Playback”

1 Turn the zoom lever in the W direction.

- Turn the zoom lever in the W direction and you can switch the display methods in the following order: 1-picture screen (full-screen) → 12-picture screen → 30-picture screen → Calendar screen. (Turn the lever in the T direction to return.)
- When you select a picture using the cursor buttons and then press [MENU/SET] on the 12-picture or 30-picture screen, the selected picture is displayed on the 1-picture screen (full-screen).
- Pictures can also be selected with the control dial.

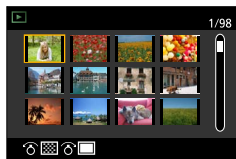
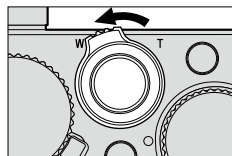

- [!] indicates that that picture cannot be played back.

Viewing pictures by their recording date “Calendar Playback”

- 1** Turn the zoom lever in the W direction to display the calendar screen.

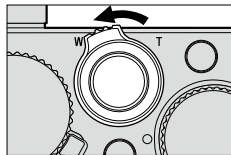

- 2** Use ▲▼◀▶ to select the recording date, and then press [MENU/SET].

- Pictures are displayed in a 12-picture screen.
- You can also select the date with the control dial.

Selected date



- You can display the calendar between January 2000 to December 2099.
- Only months when pictures were taken are shown on the calendar screen. Pictures taken without clock settings are displayed with the date 1st January, 2014.
- Pictures taken with destination settings made in [World Time] are displayed in the calendar screen using the appropriate date for the destination's time zone.

Viewing motion pictures

The camera was designed to play motion pictures recorded in the MP4 format.

1 Select a picture with the motion picture icon (🎬) in playback mode, and then press ▲ to start playback.

- After playback starts, the elapsed playback time is displayed on the screen.



Motion picture recording time

Example:
28 minutes and
30 seconds: [28m30s]

Operations during motion picture playback

▲ : Pause/play

▼ : Stop

◀ : Fast rewind (2 steps*)/Single-frame rewind (while paused)

▶ : Fast forward (2 steps*)/Single-frame forward (while paused)

Control dial (counterclockwise): Volume down

Control dial (clockwise): Volume up

[MENU/SET]: Capturing still pictures from motion pictures (while paused) (→200)

* The fast forward or rewind speed increases if you press ◀▶ again.

- If ▲ is pressed during fast forward or rewind, it will return to normal playback speed.

- Motion pictures can be viewed on your computer using the software available after registering your camera on the Leica Camera AG home page (→253).

- **With camera models 18 471 / 18 472:**

Motion pictures that were recorded by setting the picture effect (Filter) to [Miniature Effect] are played back at approximately 10x speed.

- **With camera models 18 470 / 18 473:**

Motion pictures that were recorded by setting the picture effect (Filter) to [Miniature Effect] are played back at approximately 8x speed.

Switching the Display Information of the Playback Screen

You can disable the display of picture information (file number, etc.) and recording information (settings used for recording, etc.) when a picture is played back.

1 Press [DISP] to switch the display.

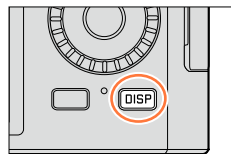

- The display is switched as shown below.

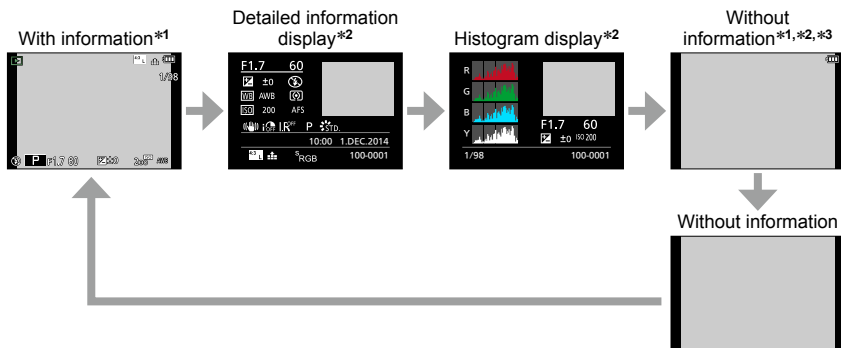

*1 If you do not perform any operation for approximately 1 minute or longer, some of the information on the screen is turned off. To display the information again, press [DISP].

*2 During Playback Zoom, Motion Picture Playback, Automatic Scrolling Playback of panorama pictures, continuous playback or Slide Show: You can only turn the display on or off.

*3 This screen is displayed only when [Highlight] (→72) in the [Custom] menu is set to [ON].

- A histogram of each color, i.e. R (red), G (green), B (blue), and Y (luminance), is separately displayed during playback.
- During Multi Playback or calendar screen: The display cannot be changed.

Switching the Display Information of the Playback Screen

 **Enabling/disabling the overexposed area display****MENU** → **C** [Custom] → [Highlight] → [ON] / [OFF]

You can set overexposed areas (areas that are too bright, i.e. 'blown highlights') to flash on the screen when the [Auto Review] function is activated or during playback. This does not affect recorded the pictures.

- To reduce overexposure, use a negative exposure compensation (→135) using the histogram display (→64) as a reference. (The right side of the histogram represents overexposure.)
- This feature is disabled during Multi Playback, Calendar Playback or Playback Zoom.

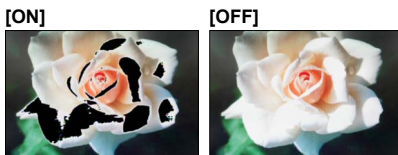

Deleting Pictures

Deleted pictures cannot be recovered.

Pictures will not be deleted in the following cases:

- With protected pictures.
- With the card's slider in the "LOCK" position.
- With pictures that are not based on the DCF standard. (→67)

- Do not turn off the camera while deleting.
- Use a sufficiently charged battery.

[Delete Single]

1 Press [C/D] to delete the displayed picture.

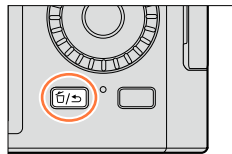

2 Use ▲ to select [Delete Single], and then press [MENU/SET].

- A confirmation screen is displayed. Select [Yes], and press [MENU/SET].

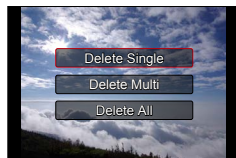

- You can set either [Yes] or [No] as the default setting on the deletion confirmation screen when you perform [Delete Confirmation] in the [Playback] menu. [No] is set at the time of purchase. (→220)

Deleting multiple (up to 100)/all pictures

A picture group (→198) is handled as 1 picture. (All the pictures in the selected picture group are deleted.)

1 Press [G/Δ] while viewing a picture.

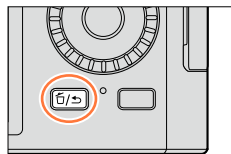

2 Use ▲▼ to select [Delete Multi]/[Delete All], and then press [MENU/SET].

- Items can also be selected by turning the control dial.
- When [Delete All] is selected
→ A confirmation screen is displayed. Select [Yes], and then press [MENU/SET].
- You can select [All Delete Except Favorite] in [Delete All] if there are pictures that have been set as [Favorite] (→216).



3 (When [Delete Multi] is selected): Use ▲▼◀▶ to select the pictures, and then press [MENU/SET].

- To cancel → Press [MENU/SET] again.
- Pictures can also be selected with the control dial.

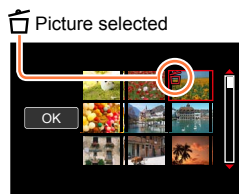

4 (When [Delete Multi] is selected): Use ◀ to select [OK], and then press [MENU/SET].

- A confirmation screen is displayed. Select [Yes], and then press [MENU/SET].
- May take time depending on number of pictures deleted.

Using Snapshot Mode

Mode: [A]

When you wish to leave settings to the camera, use this mode, in which the camera optimizes settings to match the subject and recording environment.

The camera optimizes the settings and the following functions are activated automatically.

- Automatic Scene Detection / Backlight Compensation / [Face/Eye Detection] / Auto White Balance / Intelligent ISO sensitivity control / [Red-Eye Removal] / [i.Zoom] / [i.Resolution] / [Stabilizer] / [i.Dynamic] / [Long Shtr NR] / [Quick AF] / [AF Assist Lamp]

1 Press [A].

The camera switches to [Snapshot Mode].

- When you press [A] again, the recording mode is switched to one that is set using the aperture ring and shutter speed dial.

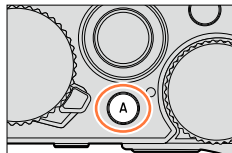

2 Frame your subject.

- When the camera identifies the scene, the icon for the respective scene mode turns blue for 2 seconds and then changes to the normal red indication.
- When you press ◀, and then press the shutter button halfway, AF Tracking is activated. For details (→117).



Changing the operation method of the [A] button

MENU → **fC [Custom]** → **[A Button Switch]**

[Single Press]: When you press [A], the camera switches to [Snapshot Mode].

[Press and hold]: If you press and hold [A], the camera switches to [Snapshot Mode].

Automatic Scene Detection

When taking pictures

[i-Portrait]	[i-Scenery]	[i-Macro]	[i-Night Portrait]*1
[i-Night Scenery]	[i-Handheld Night Shot]*2	[i-Food]	[i-Baby]*3
[i-Sunset]	A When the subject does not correspond to any of the scene modes above		

*1 When a flash unit (supplied/optional) is used

*2 When [i-Handheld Night Shot] is [ON]. (→78).

*3 When children (that are registered in the camera with Face Recognition) under 3 years old are recognized.

When recording motion pictures

[i-Portrait]	[i-Scenery]	[i-Low Light]	[i-Macro]
A When the subject does not correspond to any of the scene modes above			

- In [i-Portrait], [i-Night Portrait], and [i-Baby], the camera focuses on the eye that is closest to the camera and matches the exposure to the face. In [Snapshot Mode], the eye to be focused on cannot be changed. (**[Face/Eye Detection]**)
- When the camera identifies [i-Handheld Night Shot] as the optimal scene mode and if the camera determines that camera shake is reduced by the use of a tripod or by other means, a shutter speed that is slower than usual may be selected. After pressing the shutter button, do not move the camera while recording.
- Automatic Scene Detection does not function until the focus is locked on a subject during AF Tracking.
- When [Face Recog.] is set to [ON] and if the camera recognizes a face similar to a registered face, [R] is displayed on the upper right corner of the [i-Portrait], [i-Night Portrait], and [i-Baby] icons.

- Depending on recording conditions, different scene modes may be determined for the same subject.



About Backlight Compensation

Backlight compensation is automatically activated in [Snapshot Mode]. Backlight is a condition where the main subject is significantly darker than the rest of the frame. In such cases, the subject would be rendered too dark and so the camera automatically attempts to compensate by increasing the overall brightness of the picture.

Using a flash unit (supplied/optional)

- 1 Turn off the camera.
- 2 Remove the hot shoe cover.
- 3 Attach the flash unit.
- 4 Turn on the camera and the flash unit.

For details (→177, 261).

■ Flash

When the [ON/OFF] switch for the flash unit (supplied/optional) is set to [OFF], the flash mode is set to [☒] (Forced Flash Off). When the switch is set to [ON], the flash mode is set to [iA] (Auto).

When the flash unit is turned on, the camera automatically sets [iA], [iA], [iA] (Auto/Red-Eye Reduction), [iA], or [iA] based on the type of subject and brightness.

- When [iA] or [iA] is displayed, the [Red-Eye Removal] function is activated to automatically detect red-eye and correct the picture data.
- When [iA] or [iA] is selected, slower shutter speeds may be used.

Available menu items

You can set only the following menus.

Menu	Item
[Rec]	[Picture Size] / [Quality] / [AFS/AFF/AFC] / [Burst Rate] / [Self Timer] / [iHandheld Night Shot] / [iHDR] / [Time Lapse Shot] / [Stop Motion Animation] / [Face Recog.]
[Motion Picture]	[Rec Quality] / [AFS/AFF/AFC]
[Custom]	[Silent Mode] / [Guide Line] / [Remaining Disp.]
[Setup]	All menu items can be set. (→41)

Taking pictures using the camera handheld ([iHandheld Night Shot])

If a night scene is detected automatically while the camera is being handheld, [iHandheld Night Shot] can record a still picture with less subject blurring and less noise without using a tripod by combining several exposures.

MENU →  **[Rec]** → **[iHandheld Night Shot]** → **[ON] / [OFF]**

- The angle of view is slightly smaller.
- A message indicating that multiple exposures are to be recorded appears on the screen. After the shutter button has been pressed, do not move the camera until after the last exposure.
- When the camera is attached to a tripod or steadied by other means, [iHandheld Night Shot] will not be identified.
- The flash is fixed to the  (Forced Flash Off) setting.



- This function will not work for still pictures while motion pictures are being recorded.
- [iHandheld Night Shot] cannot be used in the following cases:
 - When using [Time Lapse Shot]
 - When using [Stop Motion Animation] (only available with [Auto Shooting] setting)

Combining several exposures into a single picture with rich gradation ([iHDR])

When there is, for example, strong contrast between the brightest and the darkest parts of the scene, [iHDR] records multiple exposures with differing brightness and combines them to create a single still picture rich in gradation.

[iHDR] is activated when required. When activated, [HDR] will be displayed on the screen.

MENU →  **[Rec]** → **[iHDR]** → **[ON] / [OFF]**

- The angle of view is slightly smaller.
- A message indicating that multiple exposures are to be recorded appears on the screen. After the shutter button has been pressed, do not move the camera until after the last exposure.
- Since a series of still exposures are combined after they have been recorded, it will take a few moments before you can record another picture.
- Due to the combining of several exposures, double images may appear if the subject was moving.



- This function will not work for still pictures while motion pictures are being recorded.
- [iHDR] cannot be used in the following cases:
 - When flash is used
 - When using [Burst]
 - When using [Time Lapse Shot]
 - When using [Stop Motion Animation] (only available with [Auto Shooting] setting)

Taking Pictures Using the Exposure Control Modes P, A, S, and M

You can set the exposure using the aperture ring and the shutter speed dial. You can also change various settings in the [Rec] menu, and apply picture effects. (→89)

Recording mode	Aperture ring	Shutter speed dial
P [Program AE] Mode (→81)	[A] (AUTO)	[A] (AUTO)
A [Aperture-Priority] Mode (→83)	You set the desired value*1	[A] (AUTO)
S [Shutter-Priority] Mode (→84)	[A] (AUTO)	You set the desired value*2
M [Manual Exposure] Mode (→86)	You set the desired value*1	You set the desired value*2

- In [Aperture-Priority], [Shutter-Priority], and [Manual Exposure] modes, the actual brightness of the picture as a result of the aperture value and the shutter speed you have set is not visible on the recording screen. To check the effect on the recording screen, use [Preview] Mode.(→88)

The brightness of the screen may vary from the actual pictures recorded. Check the brightness of pictures using the Playback Mode.

A faster shutter speed than the set shutter speed may be used when you record a motion picture.

*1 You can set aperture values between F1.7 and F16.

You may not be able to select some values depending on the set focal length.

*2 You can set shutter speeds between 1s and 1/4000s.

Turn the control ring or the control dial to set the shutter speed in the following cases.

- Faster speeds than 1/4000s or slower shutter speeds than 1s
- Shutter speed setting in 1/3 EV steps

Taking pictures using the exposure control modes **P**, **A**, **S**, and **M**

Program Mode

Mode: **P**

The camera automatically sets the shutter speed and the aperture value according to the brightness of the subject.

1 Turn the aperture ring to select **[A] (AUTO)**.

Set to the respective click-stop position.

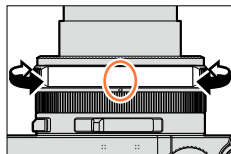

2 Turn the shutter speed dial to select **[A] (AUTO)**.

[Program AE] Mode is set and the recording mode icon changes to **[P]**.

Align the respective setting with the index.

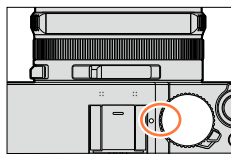

3 Press the shutter button halfway.

- If the exposure is not adequate when the shutter button is pressed halfway, the aperture value and the shutter speed turn red and flash.

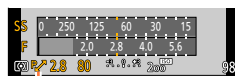

Program Shift indication

4 While the values are displayed in yellow (for approx. 10 seconds), you can perform Program Shift by turning the control dial. (→82)

- To cancel Program Shift, either turn off the camera or turn the control dial until the Program Shift indication turns off.
- Use the exposure compensation dial to set a compensation value. (→135)



Enabling/disabling the shutter speed/aperture indication

MENU → **/C [Custom]** → **[Expo.Meter]** → **[ON] / [OFF]**

- When you set this function to **[ON]**, the shutter speed/aperture indication is displayed during Program Shift, aperture setting, and shutter speed operation.
- A proper exposure is not possible in the range indicated in red.
- If the shutter speed/aperture indication is not displayed, press **[DISP]** to switch the display of the monitor. (→62)
- The shutter speed/aperture indication will turn off if no operation is performed for approximately 4 seconds.

Shutter speed/aperture indication

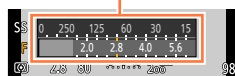

Taking pictures using the exposure control modes **P**, **A**, **S**, and **M**

About Program Shift

In Program Mode, you can change the preset aperture value and shutter speed combinations without changing the exposure. This is called Program Shift. You can e.g. reduce the extent of the sharply rendered subject parts by decreasing the aperture value or render a moving subject more dynamically by slowing the shutter speed.

<Example of Program Shift>

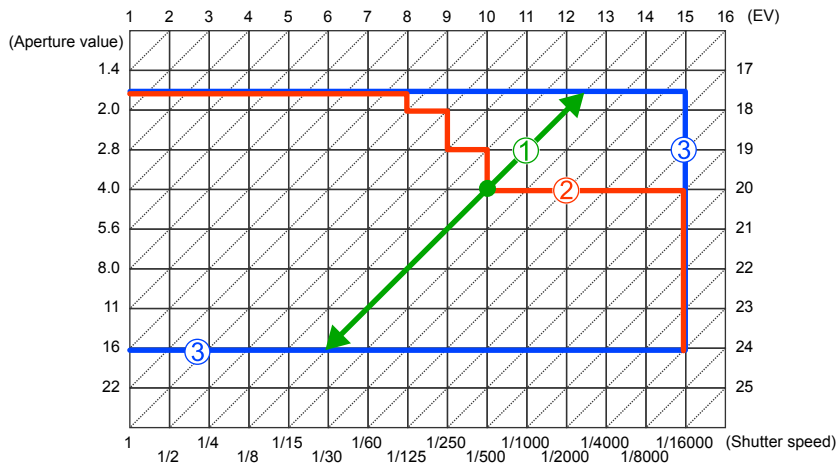

- ① Program Shift range
- ② Program Shift line chart
- ③ Program Shift limit

- EV is an abbreviation of "Exposure Value", a unit indicating the amount of exposure. The EV changes with the aperture value or the shutter speed.



- Program Shift cannot be used in the following cases:
 - During motion picture recording
 - When [Sensitivity] is set to [ISO]

Taking pictures using the exposure control modes **P**, **A**, **S**, and **M**

Aperture-Priority Mode

Mode: **A**

Set the aperture value to a higher number when you want a larger in-focus area (in front of and behind the main subject), or to a lower number for the opposite

1 Turn the shutter speed dial to select [A] (AUTO).

Align the respective setting with the index.

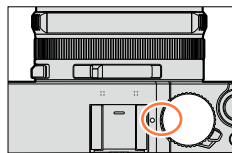

2 Turn the aperture ring to select the aperture value.

[Aperture-Priority] Mode is set and the recording mode icon changes to [A].

Set to the desired click-stop position.

- Use the exposure compensation dial to set a compensation value. (→135)

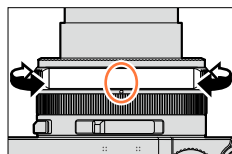

Manually settable aperture value range*	Automatically controlled shutter speed range
F1.7 - F16	60 - 1/4000s (When the mechanical shutter is used) 1 - 1/16000s (When the electronic shutter is used)

* You may not be able to select some values depending on the focal length set on the lens.



Shutter speed/
aperture indication
Aperture value

- When you turn the aperture ring, the shutter speed/aperture indication is displayed. If the correct exposure is not achieved, the aperture value is shown in red.
- If the exposure is not adequate, the aperture value and the shutter speed turn red and flash when the shutter button is pressed halfway.

Taking pictures using the exposure control modes **P**, **A**, **S**, and **M**

Shutter-Priority Mode

Mode: **S**

Set a faster shutter speed if you want to take a sharp picture of a moving subject, or a slower shutter speed if you want to create e.g. subject blur to emphasize a movement.

1 Turn the aperture ring to select **[A]** (AUTO).

Set to the respective click-stop position.

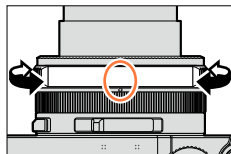

2 Turn the shutter speed dial to select the shutter speed.

[Shutter-Priority] Mode is set and the recording mode icon changes to **[S]**.

Align the desired value with the index.

- Use the exposure compensation dial to set a compensation value. (→135)

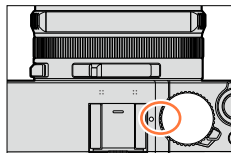

Manually settable shutter speed range	Automatically controlled aperture value range
60 - 1/4000s (When the mechanical shutter is used)	F1.7 - F16
1 - 1/16000s (When the electronic shutter is used)	

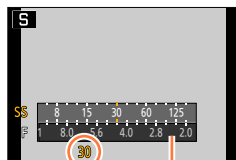

Shutter speed/
aperture
indication

Shutter speed

■ Setting the shutter speed to values not provided on the shutter speed dial

Turn the control ring or the control dial to set the following shutter speeds. Check the shutter speed on the screen.

For details on setting the type of shutter, refer to (→140).

- Faster speeds than 1/4000s or slower speeds than 1s:
 - ① Turn the shutter speed dial to select [4000-] or [1+].
 - ② Turn the control ring or control dial to select the shutter speed.
- Shutter speed setting in 1/3 EV steps:

You can adjust the shutter speed set with the shutter speed dial in the range of $\pm 2/3$ steps.

Example: To set the shutter speed to 1/400s:

- ① Turn the shutter speed dial to select [500].
- ② Turn the control ring or control dial to select [400].

Taking pictures using the exposure control modes **P**, **A**, **S**, and **M**

- When you turn the shutter speed dial, the shutter speed/aperture indication is displayed. If the correct exposure is not achieved, the shutter speed is shown in red.
- If the exposure is not adequate, the aperture value and the shutter speed turn red and flash when the shutter button is pressed halfway.
- If you switch the recording mode to [Shutter-Priority] Mode when [Sensitivity] is set to [ISO], [Sensitivity] will change to [AUTO].
- We recommend using a tripod or self-timer with slow shutter speeds.

Taking pictures using the exposure control modes **P**, **A**, **S**, and **M**

Manual Exposure Mode

Mode: **M**

This mode allows you to determine the exposure by manually setting the aperture value and the shutter speed.

The light balance scale appears at the bottom of the screen to indicate the over-/under-/correct exposure resulting from the respective settings.

1 Turn the aperture ring to select the aperture value.

Set to the desired click-stop position.

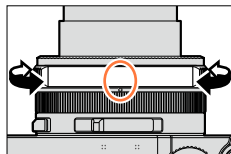

2 Turn the shutter speed dial to select the shutter speed.

[Manual Exposure] Mode is set and the recording mode icon changes to **[M]**.

Align the desired value with the index.

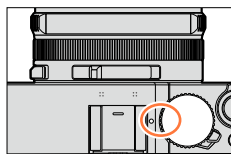

Shutter speed/
aperture indication

Manually settable aperture value range*1	Manually settable shutter speed range*2
F1.7 - F16	T (Time), 60 - 1/4000s (When the mechanical shutter is used) 1 - 1/16000s (When the electronic shutter is used)

*1 You may not be able to select some values depending on the focal length set on the lens.

*2 You may not be able to select some shutter speeds depending on the aperture value.

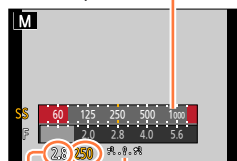

Light balance

Shutter speed

Aperture value

Setting the shutter speed to values not provided on the shutter speed dial

Turn the control ring or control dial to set the following shutter speeds. For the setting procedures, refer to (→84).

- Faster speeds than 1/4000s or slower shutter speeds than 1s
- Shutter speed setting in 1/3 EV steps

- If the set exposure is not adequate, the aperture value and the shutter speed turn red and flash when the shutter button is pressed halfway.
- If you switch the recording mode to [Manual Exposure] Mode when [Sensitivity] is set to **[B]50**, [Sensitivity] will change to [AUTO].
- We recommend using a tripod or self-timer with slow shutter speeds.

Taking pictures using the exposure control modes **P**, **A**, **S**, and **M**



Light balance (approximation)



The exposure is appropriate.



Set a faster shutter speed and/or a larger aperture value.



Set a slower shutter speed and/or a smaller aperture value.

About T (time)

When you set the shutter speed to T (time) and fully press the shutter button, the shutter opens. (for approximately up to 120 seconds)

When you press the shutter button again, the shutter closes. Use this function when you want to keep the shutter open for an extended period, for example, to record pictures of fireworks or night scenes.

- When you take pictures with the shutter speed set to T (time), make sure to use a fully charged battery (→20).
- The light balance assist is not displayed.
- If you set the shutter speed to T (time) when [Sensitivity] is set to [AUTO], [Sensitivity] will change to [200].
- You cannot use this function when the electronic shutter is used.
- You can use this function only in [Manual Exposure] Mode.



- When you take pictures with the shutter speed set to T (time), we recommend using remote recording with a tripod or smartphone as a remote shutter release (→225, 231), in order to prevent camera shake.
- When you take still pictures with the shutter speed set to T (time), the pictures may have higher noise levels. If you want to reduce noise, we recommend taking pictures by setting [Long Shtr NR] to [ON] in the [Rec] menu. (→113)



Enabling/disabling the preview of the selected aperture value and shutter speed effects on the recording screen

MENU → **ƒ** [Custom] → [Constant Preview] (M Mode) → [ON] / [OFF]

- This function is disabled when flash is used.
- You can use this function only in [Manual Exposure] Mode.

Taking pictures using the exposure control modes **P**, **A**, **S**, and **M**

Checking the effects of aperture value and shutter speed ([Preview] Mode)

Available in the following modes: **A** **P** **A** **S** **M**

The effects of the aperture and shutter speed settings can be checked by using the Preview Mode.

- **Confirming the effects of the aperture:** You can check the depth of field (in-focus range) before taking a picture. This is achieved by closing the diaphragm to the aperture value you set.
- **Confirming the effects of shutter speed:** Movement sharpness can be checked by displaying what the picture will look like that is taken with the shutter speed you set. In the case of faster shutter speeds, the display in the shutter speed preview will be like a time-release film. It is used in cases such as stopping the movement of running water.

1 Assign [Preview] to the desired function button. (→37)

- The following step is an example of assigning [Preview] to the [Fn1] button.

2 Press the [Fn1] button to switch the confirmation screen.

- Every time you press the [Fn1] button, the screen switches.



Depth of field characteristics

Recording conditions	Aperture value	Lower	Higher
	Focal length (zoom position)	Longer (Tele)	Shorter (Wide)
	Distance to a subject	Closer	Further
Depth of field (in-focus range)	Shallower Example: When you want to take a picture with a blurred background etc.	Deeper Example: When you want to take a picture with everything in focus including the background etc.	

- You can take a picture even when [Preview] Mode is activated.
- The range in which you can check the effect of a selected shutter speed is between 8s and 1/16000s.

Taking Pictures Using Additional Effects (Filter)

Available in the following modes: **A P A S M**

You can set various effects to add by selecting example images and checking them on the screen. This is also possible when taking panorama pictures.

1 Press [F].

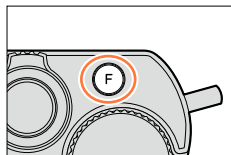

Preview display

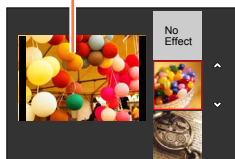

2 Press ▲▼ or turn the control dial to select the picture effect (Filter).

- You can select from among 22 picture effects (Filter). (→92 - 99)
- The picture effect for the sample picture you selected is applied to the picture shown on the preview display.

3 Press [MENU/SET].

The display of a picture with a selected picture effect appears on the screen.

Example: When the picture effect ([Sunshine]) is selected in [Program AE] Mode:

- Ⓐ Picture effects
(This is not displayed when [No Effect] is selected.)
- Ⓑ Adjusting the picture effect (→91)
(This is displayed only when a picture effect is selected.)



Changing the picture effect (Filter)

Press [F] again and perform the same procedure from step 2 above.

Taking Pictures Using Additional Effects (Filter)

- Settings will be stored even if the recording mode is changed or the camera is turned off.
- If you do not want to add picture effects, please select [No Effect].
- When you set a picture effect, the following settings are fixed.
 - White Balance: [AWB]
 - [Photo Style]: [Standard]
 - [Highlight Shadow]: [Standard]
 - [i.Dynamic]: [OFF]
 - [HDR]: [OFF]
 - [Color Space]: [sRGB]
- The flash mode is set to [☹] (Forced Flash Off).
- The display of a picture reflecting a selected effect in the preview screen or recording screen may differ from the actual recorded pictures.

Switching the display of a selection screen for applying picture effects (Filter)

1 Press [DISP] to switch the display.

- Every time you press [DISP], the screen for which picture effects are selected changes.
- When you switch the screen to the guide display, a description of the picture effects appears.

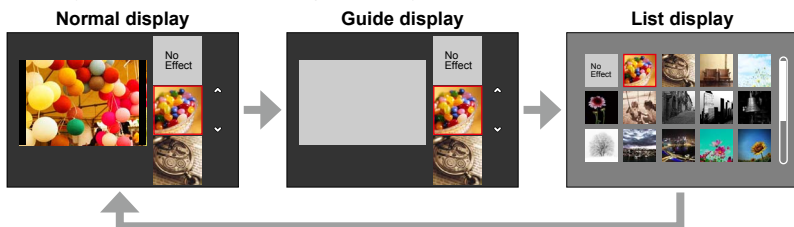

Taking Pictures Using Additional Effects (Filter)

Adjusting the picture effects according to your preferences

You can easily adjust the setting conditions (such as degree and coloring of an effect) of the picture effects according to your preferences.

1 Press ► to display the setting screen.**2 Turn the control dial to adjust the picture effect settings.**

- The settings that can be adjusted vary depending on the selected picture effect. Refer to “Items that can be set” for the corresponding picture effect.
- Press [MENU/SET] to return to the recording screen.
- When you select picture effects, [↺] appears on the screen.
- If you do not want to change the current setting, select the center point (standard) in the adjustment level bar.

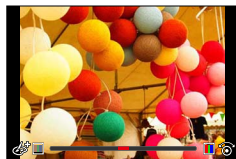
**Taking two pictures with and without picture effects ([Simultaneous record w/o filter])**

You can take two pictures at the same time with one press of the shutter button; one with effects and one without effects.

MENU → [Rec] → [Simultaneous record w/o filter]

Settings: [ON] / [OFF]

- When [ON] is set, the camera will take one picture with the effects applied and another without the effects.
 - The picture recorded without effects applied will use the same menu settings as when the picture effects (Filter) were applied. The following settings are fixed.
 - White Balance: [AWB] (You cannot perform fine adjustments.)
 - [i.Dynamic]: [OFF]
 - [Auto Review] will display only the picture with the effects applied.
- If you set this function to [ON], serial exposures, Auto Bracket, Aspect Bracket, White Balance Bracket, [Time Lapse Shot], [Stop Motion Animation] and panorama picture recording will be disabled.
 - This function is disabled during motion picture recording.

Taking Pictures Using Additional Effects (Filter)

For the setting procedures for picture effects (Filter), refer to (→89).

[Expressive]

This effect emphasizes the color to make a pop art picture.

Items that can be set (Press ► to display the setting screen.):

Color hues	Subdued	◀▶	Exaggerated
------------	---------	----	-------------

**[Retro]**

This effect gives a faded image.

Items that can be set (Press ► to display the setting screen.):

Color	Yellow emphasized	◀▶	Red emphasized
-------	-------------------	----	----------------

**[Old Days]**

This effect adds a bright, soft and nostalgic feel to the overall image.

Items that can be set (Press ► to display the setting screen.):

Contrast	Lower	◀▶	Higher
----------	-------	----	--------

**[High Key]**

This effect adds a bright, airy and soft feel to the overall image.

Items that can be set (Press ► to display the setting screen.):

Color	Pink emphasized	◀▶	Aquamarine emphasized
-------	-----------------	----	-----------------------

- When recording a panorama picture in a scene with low brightness, you may not be able to achieve the desired results.



Taking Pictures Using Additional Effects (Filter)

For the setting procedures for picture effects (Filter), refer to (→89).

[Low Key]

This effect adds a dark and therefore quiet feel to the overall image and enhances bright parts.

Items that can be set (Press ► to display the setting screen.):

Color	Red emphasized	◀▶	Blue emphasized
-------	----------------	----	-----------------

**[Sepia]**

This effect creates a sepia image.

Items that can be set (Press ► to display the setting screen.):

Contrast	Lower	◀▶	Higher
----------	-------	----	--------

**[Monochrome]**

This effect creates a black and white picture.

Items that can be set (Press ► to display the setting screen.):

Contrast	Yellow emphasized	◀▶	Blue emphasized
----------	-------------------	----	-----------------

**[Dynamic Monochrome]**

This effect uses a higher contrast to create an impressive black and white picture.

Items that can be set (Press ► to display the setting screen.):

Contrast	Lower	◀▶	Higher
----------	-------	----	--------



Taking Pictures Using Additional Effects (Filter)

For the setting procedures for picture effects (Filter), refer to (→89).

[Rough Monochrome]

This effect creates a black and white picture with noise resembling the graininess of conventional film material.

Items that can be set (Press ► to display the setting screen.):

Grittiness	Weaker	◀→	Stronger
------------	--------	----	----------

- The display of the recording screen will be delayed more than usual and the screen will look as if frames are dropping.



[Silky Monochrome]

This effect blurs the overall image to add a soft feel to a black and white picture.

Items that can be set (Press ► to display the setting screen.):

Extent of defocus	Weaker	◀→	Stronger
-------------------	--------	----	----------

- The display of the recording screen will be delayed more than usual and the screen will look as if frames are dropping.



[Impressive Art]

This effect gives your photo a dramatic contrast look.

Items that can be set (Press ► to display the setting screen.):

Color hues	Black and white	◀→	Exaggerated
------------	-----------------	----	-------------

- When recording a panorama picture, the stitching seams may be noticeable.



[High Dynamic]

This effect produces the optimum brightness for both dark and bright parts.

Items that can be set (Press ► to display the setting screen.):

Color hues	Black and white	◀→	Exaggerated
------------	-----------------	----	-------------



Taking Pictures Using Additional Effects (Filter)

For the setting procedures for picture effects (Filter), refer to (→89).

[Cross Process]

This effect gives your photo a dramatic color look.

Items that can be set (Press ► to display the setting screen.):

Color	Green tone/Blue tone/Yellow tone/Red tone
-------	---



[Toy Effect]

This effect reduces the brightness in the frame corners to give the impression of a toy camera.

Items that can be set (Press ► to display the setting screen.):

Colors	Orange emphasized	◀→	Blue emphasized
--------	-------------------	----	-----------------



[Toy Pop]

This effect creates a vivid and bright image with the look of a toy camera.

Items that can be set (Press ► to display the setting screen.):

Size of the frame corners with reduced brightness	Smaller	◀→	Larger
---	---------	----	--------



[Bleach Bypass]

This effect gives a higher contrast and a lower saturation to create a picture with a subdued atmosphere.

Items that can be set (Press ► to display the setting screen.):

Contrast	Lower	◀→	Higher
----------	-------	----	--------

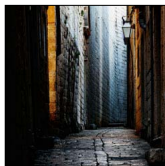

Taking Pictures Using Additional Effects (Filter)

For the setting procedures for picture effects (Filter), refer to (→89).

[Miniature Effect]

This effect blurs the frame edges to give the impression of a diorama.

Items that can be set (Press ► to display the setting screen.):

Color hue	Subdued	◀▶	Pop
-----------	---------	----	-----



■ Setting the type of defocus

With [Miniature Effect] you can make the subject stand out by intentionally creating defocused and in-focus sections. You can set the recording orientation (defocus orientation) and the position and size of the in-focus section.

- ① Press [Fn1].
- ② Press ▲▼ or ◀▶ to move the focusing area (frame).
- ③ Turn the control dial to select the size of the focusing area (frame).
- ④ Press [MENU/SET].
 - When you press [DISP], the initial setting condition is restored.

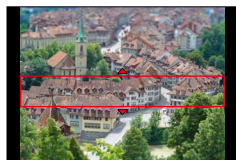

- The monitor image is displayed with a slight delay compared to normal recording.
- No audio is recorded for motion pictures.
- **With camera models 18 471 / 18 472:**
When a motion picture is recorded, the finished recording will be approximately 1/10th of the actual recorded time period. (If you record a motion picture for 10 minutes, the resulting motion picture recording time will be approximately 1 minute.) The recordable time displayed on the camera is approx. 10x longer than actual recording. When the recording mode is changed, be sure to check the recordable time.
- **With camera models 18 470 / 18 473:**
When a motion picture is recorded, the finished recording will be approximately 1/8th of the actual recorded time period. (If you record a motion picture for 8 minutes, the resulting motion picture recording time will be approximately 1 minute.) The recordable time displayed on the camera is approx. 8x longer than actual recording. When the recording mode is changed, be sure to check the recordable time.
- If you stop recording motion pictures too soon, the camera may continue recording for a certain time. Hold the camera still until the camera stops recording.
- If [MF] is selected as the focus mode, move the in-focus section to the part of the subject you focused on.

Taking Pictures Using Additional Effects (Filter)

For the setting procedures for picture effects (Filter), refer to (→89).

[Soft Focus]

This effect blurs the overall image to produce a soft feel.

Items that can be set (Press ► to display the setting screen.):

Extent of defocus	Weaker	◀→	Stronger
-------------------	--------	----	----------

- The monitor image is displayed with a slight delay compared to normal recording.

**[Fantasy]**

This effect creates a fantastical image in a pale color tone.

Items that can be set (Press ► to display the setting screen.):

Color hues	Subdued	◀→	Exaggerated
------------	---------	----	-------------

**[Star Filter]**

This effect transforms light points into stars.

Items that can be set (Press ► to display the setting screen.):

Ray length	Shorter	◀→	Longer
------------	---------	----	--------

- The monitor image is displayed with a slight delay compared to normal recording.



Taking Pictures Using Additional Effects (Filter)

For the setting procedures for picture effects (Filter), refer to (→89).

[One Point Color]

This effect lets subjects with the selected color stand out from the other (differently colored) subject parts.

Items that can be set (Press ► to display the setting screen.):

Amount of color left	Less	◀→	More
----------------------	------	----	------



■ Setting the color to retain

Set the color to retain by selecting a location on the screen.

- ① Press [Fn1].
- ② Select the color you want to retain by moving the frame with ▲▼◀▶, and then press [MENU/SET].
 - Press [DISP] to reset the frame position.



- Depending on the subject, the set color may not be retained.

Taking Pictures Using Additional Effects (Filter)

For the setting procedures for picture effects (Filter), refer to (→89).

[Sunshine]

This effect adds a cast of light to the scene.

Items that can be set (Press ► to display the setting screen.):

Color	Yellow tone/Red tone/Blue tone/White tone
-------	---



■ Changing the light source's position and size

- ① Press [Fn1].
- ② Press ▲▼◀▶ to move the center of the light source to a different position.
 - You can move the center of the light source to the edge of the screen.

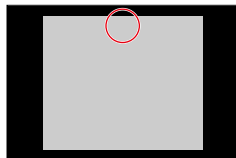

Tips on positioning the center of the light source

A more natural appearance can be created by placing the center of the light source outside the image

- ③ Turn the control dial to adjust the size of the light source.
 - You can select four light source sizes.
 - When you press [DISP], the initial setting condition is restored.
 - ④ Press [MENU/SET].
- The recording screen is displayed with a slight delay compared to normal recording.







Adjusting the Picture Quality by Adding an Effect

[Photo Style]

Available in the following modes: **A P A S M**

You can adjust the colors and picture quality according to the concept of the picture that you want to create.

MENU →  **[Rec]** → **[Photo Style]**

 STD. [Standard]	Standard setting.
 VIVID [Vivid]	Setting with slightly higher contrast and saturation.
 NAT [Natural]	Setting with slightly lower contrast.
 MONO [Monochrome]	Setting that creates a black and white picture.
 SCNY [Scenery]	Setting that creates a picture using vivid colors for the blue sky and green (e.g. foliage).
 PORT [Portrait]	Setting that produces a healthy looking complexion.
 CUST [Custom]	Setting that uses colors and picture quality which were registered in advance.

- [Photo Style] is fixed to [Standard] when the picture effect (Filter) is set.
- The menu item is common for both the [Rec] and [Motion Picture] menus. If a setting in one menu is changed, the setting with the same name in the other menu will also be changed automatically.

Adjusting the Picture Quality by Adding an Effect [Photo Style]

■ Adjusting the picture quality

① Press ◀▶ to select the type of Photo Style.

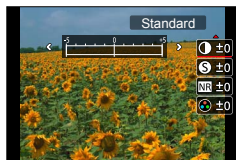

② Press ▲▼ to select an item, and then ◀▶ to adjust.

● [Contrast]	[+]	Increases the difference between the brighter and the darker parts in the picture.
	[-]	Decreases the difference between the brighter and the darker parts in the picture.
S [Sharpness]	[+]	Definition is enhanced.
	[-]	Definition is reduced (resulting in "softer" pictures).
NR [Noise Reduction]	[+]	The noise reduction effect is enhanced. The resolution may deteriorate slightly.
	[-]	The noise reduction effect is reduced. The resolution can be enhanced slightly.
● [Saturation]*1	[+]	The colors in the picture become vivid.
	[-]	The colors in the picture become subdued.
● [Color Tone]*1	[+]	Shifts towards a bluish tone.
	[-]	Shifts towards a yellowish tone.
⊗ [Filter Effect]*2	[Yellow]	Enhances the contrast of an subject. (Effect: Weak) The blue sky is rendered more clearly.
	[Orange]	Enhances the contrast of an subject. (Effect: Medium) The blue sky is rendered more vividly.
	[Red]	Enhances the contrast of an subject. (Effect: Strong) The blue sky is rendered much more vividly.
	[Green]	The skin and lips of people and green leaves appear in natural tones. Green leaves appear brighter and more emphasized.
	[Off]	—

*1 [Color Tone] is displayed only when [Monochrome] is selected. Otherwise, [Saturation] is displayed.

*2 [Filter Effect] is displayed only when [Monochrome] is selected.

• When the picture quality is adjusted, [+] will be displayed in the icon.

③ Press [MENU/SET].

■ Registering the setting for the adjusted picture quality to [Custom]

① Perform the picture quality adjustment in Step ② of "Adjusting the picture quality", and then press [DISP].

• A confirmation screen is displayed. Select [Yes], and then press [MENU/SET].

Adjusting Bright / Dark Sections [Highlight Shadow]

Available in the following modes: **A P A S M**

You can adjust the highlights and shadows in a picture while checking the results on the screen.

1 Set the menu item:

MENU → [Rec] → [Highlight Shadow]

2 Press ◀▶ to select the item.

<input checked="" type="checkbox"/> ([Standard])	No adjustments.
<input checked="" type="checkbox"/> ([Higher contrast])	Bright areas are brightened, and dark areas are darkened.
<input checked="" type="checkbox"/> ([Lower contrast])	Bright areas are darkened, and dark areas are brightened.
<input checked="" type="checkbox"/> ([Brighten shadows])	Dark areas are brightened.
/ / (Custom)	Registered custom settings are applied.

3 Turn the control ring to adjust the brightness of bright/dark parts.

- To register your preferred settings, press ▲ to select the registration target icon (Custom 1 ()), Custom 2 (), and Custom 3 ()).

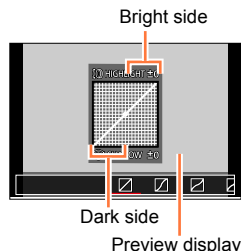

4 Press [MENU/SET].

- You can press [DISP] on the brightness adjustment screen to switch the screen display.

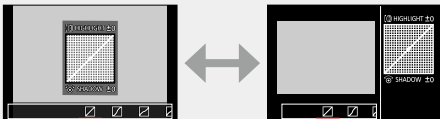

- The settings registered in , , or will be retained even if the camera is turned off.
- The settings adjusted in , , , or will be restored to the default settings when the camera is turned off.
- The menu item is common for both the [Rec] and [Motion Picture] menus. If a setting in one menu is changed, the setting with the same name in other menu will also be changed automatically.

Setting the White Balance

Available in the following modes: **A P A S M**

In sunlight, under incandescent lights or in other such conditions where the color of white takes on a reddish or bluish tinge, this function allows settings according to the prevailing light source, and thus to adjust the rendition of white to your (subjective) personal perception.

1 Press **[WB]** / (▶).

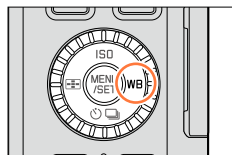

2 Turn the control dial to select the desired **White Balance** setting, and then press **[MENU/SET]**.

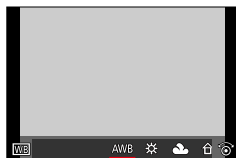

[AWB]	Automatic adjustment.
[☀]	For taking pictures outdoors under a clear sky.
[☁]	For taking pictures outdoors under a cloudy sky.
[🏠]	For taking pictures outdoors in the shade.
[💡]	For taking pictures under incandescent lights.
[WB] *	For taking pictures with flash as the main/dominant light source.
[1]/[2]/[3]/[4]	The manually metered and set value is used.
[K]	For using a preset color temperature setting.

* The [AWB] setting is applied when recording motion pictures.



Under fluorescent lighting, LED lighting fixtures, etc., the optimal White Balance will vary depending on the lighting type, so use [AWB], [☀], [☁], [🏠] or [💡].

- The White Balance is only calculated for subjects within the range of the flash unit in use (→178).
- The [White Balance] setting is fixed to [AWB] when the picture effect (Filter) is set.

Setting the White Balance

■ Auto White Balance

Depending on the conditions prevailing when pictures are taken, they may take on a reddish or bluish tinge. Furthermore, when a multiple number of light sources is being used or there is nothing with a color close to white, Auto White Balance may not function properly. In a case like this, set the White Balance to a mode other than [AWB].

 : [AWB] operational range

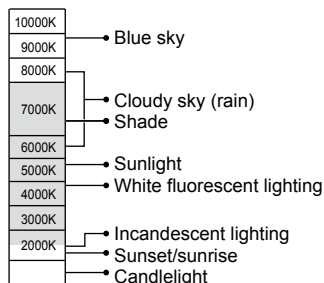

K=Color temperature in degrees Kelvin

Setting the White Balance manually

This mode allows metering any specific situation and storing the according White Balance setting.

- 1 Press [WB] (▶).
- 2 Turn the control dial to select [1], [2], [3], or [4], and then press ▲.
- 3 Point the camera at a white object such as a piece of paper, ensuring that it fills the frame in the center completely, and then press [MENU/SET].

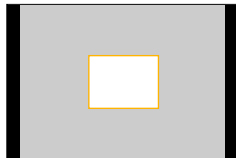

- It may not be possible to set the correct White Balance if subjects are too bright or too dark. Set it again after adjusting the exposure to appropriate brightness.

Setting the White Balance

Setting the color temperature

You can set the color temperature manually for taking natural pictures in different lighting conditions.

The color of light is measured as a number in degrees Kelvin. As the color temperature increases, the picture becomes more bluish, as it decreases, more reddish.

- 1 Press [WB] (▶).
- 2 Turn the control dial to select [K], and then press ▲.
- 3 Use ▲ ▼ to select the color temperature value, and then press [MENU/SET].
 - You can set the color temperature from 2,500 K to 10,000 K.



Finely adjusting the White Balance

You can finely adjust the White Balance when you cannot acquire the desired hue with the available fixed settings.

- 1 Select the desired White Balance setting, and then press ▼.
- 2 Use ▲ ▼ ◀ ▶ to perform White Balance fine adjustments.
 - ◀: A (amber: orangish colors) ▶: B (blue: bluish colors)
 - ▲: G (green: greenish colors) ▼: M (magenta: reddish colors)
 - Pressing [DISP] resets the position back to the center.
- 3 Press [MENU/SET].

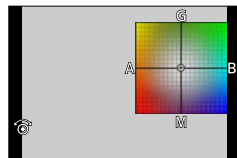

- When you perform White Balance fine adjustments toward the A (amber) or B (blue) side, the color of the White Balance icon displayed on the screen will change to the fine-tuned color.
- When you perform White Balance fine adjustments toward the G (green) or M (magenta) side, [+] (green) or [-] (magenta) will be displayed in the White Balance icon on the screen.
- Settings remain applied when using flash.
- You can perform White Balance fine adjustments independently for each White Balance setting item.
- When you set a new White Balance value by selecting [1], [2], [3], or [4], or change the color temperature by selecting [K], the White Balance fine adjustment level will be returned to the standard setting (center point).

Setting the White Balance

White Balance Bracketing

Bracket settings are performed based on the values for White Balance fine adjustment. Three pictures with different color rendition are automatically recorded when the shutter button is pressed once.

1 Perform White Balance fine adjustments in step 2 of “Finely adjusting the White Balance” and turn the control dial to perform the bracket setting.

Turning the control dial to the right : Horizontal ([A] to [B])

Turning the control dial to the left : Vertical ([G] to [M])

2 Press [MENU/SET].

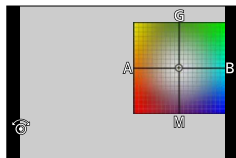

- When White Balance Bracketing is set, [BKT] appears on the White Balance icon.
- When the camera is turned off (Including [Sleep Mode]), the White Balance Bracket setting is canceled.
- The shutter sound will be emitted only once.



- White Balance Bracketing does not function in the following cases:
 - During panorama picture recording
 - During motion picture recording
 - When [4K PHOTO] is set to [ON]
 - When the [Quality] setting is [RAW:16:1], [RAW:12:1] or [RAW]
 - When [HDR] is set to [ON]
 - When [Multi Exp.] is set
 - When using [Time Lapse Shot]

Setting Picture Quality and Resolution

Changing the aspect ratio of still pictures

Available in the following modes: **A P A S M**

You can easily switch the aspect ratio of still pictures using the aspect ratio selector switch.

1 Available aspect ratio settings

[4:3]	Aspect ratio of conventional CRT-TVs
[1:1]	Aspect ratio of a square image
[16:9]	Aspect ratio of high-definition TVs, etc.
[3:2]	Aspect ratio of 35mm film cameras

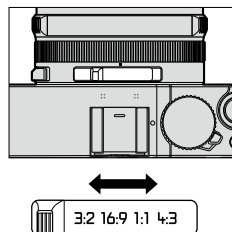

- Edges may be cut off when printing - be sure to check in advance. (→292)



The function is not available during panorama picture recording.

Setting Picture Quality and Resolution

Setting the resolution

Available in the following modes: **A P A S M**

The higher the resolution, the more details the pictures will contain. This becomes more and more evident, the larger the picture is reproduced.

MENU →  **[Rec]** → **[Picture Size]**

Aspect ratio	4:3	1:1	16:9	3:2
[Picture Size]	[L] 12.5M 4112×3088	[L] 10M 3088×3088	[L] 11M 4480×2520	[L] 12M 4272×2856
	[EX M] 6.5M 2976×2232	[EX M] 5M 2240×2240	[EX M] 8M 3840×2160	[EX M] 6.5M 3120×2080
	[EX S] 3M 2048×1536	[EX S] 2.5M 1536×1536	[EX S] 2M 1920×1080	[EX S] 3M 2112×1408

- When [Burst Rate] is set to [SH], [Picture Size] is fixed to [S].



The function is not available during panorama picture recording.





Setting the compression rate of pictures ([Quality])

Available in the following modes: **[A] [P] [A] [S] [M]**

This function allows you to select the file format, e. g. JPEG and/or RAW, and in the case of JPEG, the compression rate. [RAW] is especially suited for the subsequent comprehensive editing of the image data using respective software such as Adobe® Photoshop® Lightroom®, which is available after registering your camera on the Leica Camera AG homepage (→253). The JPEG setting [Fine] delivers higher image quality than [Standard] due to its lower compression rate, while the latter has the advantage of smaller files.

Set the compression rate used for saving pictures:

MENU →  **[Rec]** → **[Quality]**

Settings	File format	Description
	JPEG	Gives priority to picture quality and saves pictures in JPEG file format.
		Saves pictures in JPEG file format using standard picture quality. This setting is useful when you want to increase the number of recordable pictures without changing the resolution.
	RAW + JPEG	Saves pictures simultaneously in JPEG and RAW file formats.*1
		
	RAW	Saves pictures in the RAW file format.*2

*1 If you delete a RAW file from the camera, the corresponding JPEG file is also deleted.

*2 The resolution is fixed to the maximum setting for each image aspect ratio ([L]).



About the RAW file format

In RAW file format, the data is saved without any picture processing by the camera. This format delivers a higher picture quality than the JPEG format, but the amount of data is greater. To play back and edit RAW file pictures, you must use the camera or dedicated picture processing software.

You can perform advanced editing of RAW file pictures, such as correcting the White Balance of pictures recorded previously, and save the pictures in file formats that can be displayed on a computer.

- You can develop the RAW file pictures using [RAW Processing] in the [Playback] menu. (→205)

Setting Picture Quality and Resolution



- The following effects cannot be used on RAW file pictures:
 - [Snapshot Mode]
 - Picture effects (Filter)
 - White Balance*1
 - [Photo Style]*1 / [Highlight Shadow]*1 / [i.Dynamic]*1 / [Red-Eye Removal]*2 / [i.Resolution]*1 / [Color Space]*1 ([Rec] menu)
- You cannot set to [RAW], [RAW] or [RAW] during panorama picture recording.

*1 When you use [RAW Processing] in the [Playback] menu, the adjustments are made based on the settings used during recording. Therefore, you can save JPEG file pictures by using the settings applied during recording.

*2 If [Red-Eye Removal] is activated during recording, you can use [RAW Processing] in the [Playback] menu to save JPEG file pictures in which red-eye was detected and corrected.

Using the Picture Correction Functions Effectively

Correcting contrast and exposure ([i.Dynamic])

Available in the following modes: **A P A S M**

This function automatically adjusts contrast and exposure to give more lifelike colors when there is significant contrast between background and subject.

MENU →  **[Rec]** → **[i.Dynamic]**

Settings: **[AUTO]** / **[HIGH]** / **[STANDARD]** / **[LOW]** / **[OFF]**

- When **[AUTO]** is set, you can automatically set the strength of the effects based on the recording conditions.
- The menu item is common for both the **[Rec]** and **[Motion Picture]** menus. If a setting in one menu is changed, the setting with the same name in other menu will also be changed automatically.



- Compensation effect may not be achieved depending on the conditions.
- The **[i.Dynamic]** does not function in the following cases:
 - During panorama picture recording
 - When **[HDR]** is set to **[ON]**

Enhancing the impression of high resolution ([i.Resolution])

Available in the following modes: **A P A S M**

You can use the camera's Intelligent Resolution technology to record still pictures with sharper outlines and clearer resolution.

MENU →  **[Rec]** → **[i.Resolution]**

Settings: **[HIGH]** / **[STANDARD]** / **[LOW]** / **[EXTENDED]** / **[OFF]**

- When **[EXTENDED]** is set, you can take more natural pictures with the impression of a higher resolution.
- The **[EXTENDED]** setting will automatically change to the **[LOW]** setting when recording motion pictures.
- The menu item is common for both the **[Rec]** and **[Motion Picture]** menus. If a setting in one menu is changed, the setting with the same name in other menu will also be changed automatically.

Using the Picture Correction Functions Effectively

Combining still pictures with different exposures ([HDR])

Available in the following modes: **A P A S M**

The camera can combine 3 pictures taken with different brightness levels into a single one with rich gradation. The individual exposures used to create the HDR picture are not saved. This allows you to improve the rendition in bright and dark areas that would otherwise not contain any detail.

A combined HDR picture is saved in JPEG format.

MENU →  **[Rec]** → **[HDR]**



[ON]	Creates a combined HDR picture.	
[OFF]	Does not create a combined HDR picture.	
[SET]	[Dynamic Range]	<p>[AUTO]: Takes pictures after automatically setting the adjustment range of the exposure based on the contrast of a subject.</p> <p>[±1EV] / [±2EV] / [±3EV]: Takes pictures using the set exposure adjustment range.</p>
	[Auto Align]	<p>[ON]: Automatically adjusts the misalignment of pictures caused by camera shake, etc. We recommend using this setting to take pictures with a handheld camera.</p> <p>[OFF]: Does not adjust the misalignment of pictures. We recommend using this setting when you use a tripod.</p>

What is HDR?

HDR stands for High Dynamic Range and refers to a technique for the rendition of a wider contrast range than possible with a single exposure.

- After the shutter button has been pressed, do not move the camera during the exposure series.
- Since a series of still pictures are combined after they have been recorded, it will take a few moments before you will be able to record another picture.
- A subject that was in motion when it was recorded may lead to a blurred image.
- When [Auto Align] is set to [ON], the angle of view is slightly smaller.
- When you take pictures using a flash, the flash mode is fixed to  (Forced Flash Off).



- This function will not work for still pictures while motion pictures are being recorded.
- [HDR] cannot be used in the following cases:
 - When the [Quality] setting is set to [RAW , [RAW ] or [RAW]
 - When using [Time Lapse Shot]
 - When using [Stop Motion Animation] (only available with [Auto Shooting] setting)

Using the Picture Correction Functions Effectively

Reducing the noise in long exposures ([Long Shtr NR])

Available in the following modes: **A P A S M**

The camera can automatically eliminate the noise resulting when taking pictures with a slower shutter speed (e.g. to record night scenes).

MENU →  **[Rec]** → **[Long Shtr NR]**

Settings: **[ON]** / **[OFF]**

- While the camera eliminates the noise, [Long shutter noise reduction ongoing] is displayed for the same period as the shutter speed selected for the signal processing time.



- [Long Shtr NR] does not function in the following cases:
 - During panorama picture recording
 - During motion picture recording
 - When [Burst Rate] is set to [SH]
 - When using the electronic shutter

Setting the color space

Available in the following modes: **A P A S M**

You can set the method for reproducing the colors to correctly display the recorded pictures on the screens of a computer or a printer, etc.

MENU →  **[Rec]** → **[Color Space]**

[sRGB]	Sets the sRGB color space. This setting is widely used for devices such as computers.
[AdobeRGB]	Sets the AdobeRGB color space. AdobeRGB color space has a wider color reproduction range than sRGB color space. Therefore, AdobeRGB color space is mainly used for business applications such as commercial printing.

- Select [sRGB] if you do not have expert knowledge about AdobeRGB color space.
- During motion picture recording, the setting is fixed to [sRGB].

Using Autofocus

- 1** Switch the focus mode selector switch to [AF] or [AF ∞].

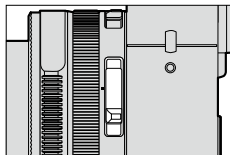

Autofocus is activated.

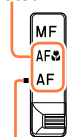

Align with the index mark.

Selecting the focus mode (AFS, AFF, AFC)

Available in the following modes: **[A]** **[P]** **[A]** **[S]** **[M]**

The selected mode determines how focusing works when the shutter button is pressed halfway.

MENU → **[Rec]** → **[AFS/AFF/AFC]**

Focus selector switch	Settings	The movement of the subject and the scene (recommended)	Description
AF* AF ∞ *	[AFS]	Subject is still (Scenery, anniversary photograph, etc.)	"AFS" is an abbreviation of "Autofocus Single". Focus is set automatically when the shutter button is pressed halfway. Focus will be fixed while it is pressed halfway.
	[AFF]	Movement cannot be predicted (Children, pets, etc.)	"AFF" is an abbreviation of "Autofocus Flexible". In this mode, focusing is performed automatically when the shutter button is pressed halfway. If the subject moves while the shutter button is pressed halfway, the focus is corrected to match the movement automatically.
	[AFC]	Subject is moving (Sport, trains, etc.)	"AFC" is an abbreviation of "Autofocus Continuous". In this mode, while the shutter button is pressed halfway, focusing is constantly performed to match the movement of the subject. When the subject is moving, the focusing is performed by predicting the subject position at the time of recording.
MF	—	—	Focusing is performed manually. (→128)

* In [Snapshot mode], the setting is fixed to AF Macro even if you switch the focus selector switch to [AF] or [AF ∞] (AF Macro).



When recording using [AFF], [AFC]

- Focusing may take time if the focal length is changed from max. W to max. T, or if you suddenly move closer to a subject from a greater distance.
- Press the shutter button halfway again when it is difficult to focus on the subject.
- While the shutter button pressed halfway, shake may be seen on the screen.

- If a subject is insufficiently illuminated when using [AFF] or [AFC], the camera performs the same focusing operation as [AFS]. In this case, the indication on the screen will change to yellow [AFS].



- The camera uses [AFS] for focusing during panorama picture recording

Switching [AF Mode]

Available in the following modes: **A P A S M**

This option allows selecting the focusing method that suits the positions and number of the subjects.

1 Press (◀).

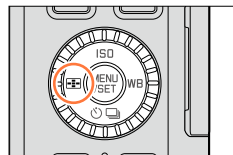

2 Press ◀▶ to select Auto Focus mode, and then **[MENU/SET]**.

- If you press ▼ when , , , or is selected, the AF area setting screen appears. For details on operation of the AF area setting screen, refer to (→121).

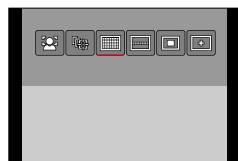

- The Autofocus mode is fixed to (1-area-focusing) when the picture effect (Filter) is set ([Miniature Effect]).



- This mode cannot be set to (Pinpoint-focusing) when [AFS/AFF/AFC] (→114) is set to [AFF] or [AFC].

About (Face/Eye Detection)

The camera automatically detects a person's face and eyes. The eye closer to the camera will be in focus, while the exposure will be optimized for the face (when [Metering Mode] is set to  (Multi Metering)).

- The camera can recognize up to 15 registered faces. Only the eyes of the face that is in focus can be detected.

When the camera detects a face, the AF area and the mark indicating the eye to be in focus are displayed.



Yellow: When the shutter button is pressed halfway, the frame turns green when the camera has focused.

White: Is displayed when more than one face is detected.

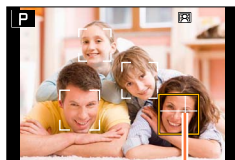
Other faces that are the same distance away as faces within the yellow AF area are also focused.



Eye determining for focusing

- **You can change the position and size of the AF area and the eye to be focused on.** (→121)
- If [Metering Mode] is set to  (Multi Metering) when  (Face/Eye Detection) is selected, the camera will adjust the exposure using the face of the subject. (→139)



- If conditions prevent the face from being recognized, such as when the movement of the subject is too rapid, the AF Mode setting switches to  (49-area-focusing).



Automatically locking the focus on a moving subject



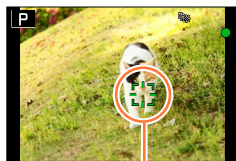

1 Aim the AF Tracking frame at the subject, and then press the shutter button halfway.

When the subject is recognized, the AF Tracking frame changes from white to yellow, and the subject is automatically kept in focus. If AF Lock fails, the frame flashes in red for a while and then turns off. Retry the locking operation.





AF Tracking frame

- To release AF Tracking → Press [MENU/SET].
- Focus range: same as macro recording []
- In [Snapshot Mode], every time you press , AF Tracking and Face Detection are switched.

- When you set [Metering Mode] to [] (Multi Metering), the camera adjusts the exposure using the locked subject. (→139)
- Under certain recording conditions, such as when the subject is small or dark, [] (AF Tracking) may not operate correctly. When [] (AF Tracking) does not work, focus will be on [] (1-area-focusing).



- [] (AF Tracking) cannot be used when using [Time Lapse Shot].
- In the following cases, [] (AF Tracking) performs the operation of [] (1-area-focusing):
 - When the picture effect (Filter) is set ([Sepia], [Monochrome], [Dynamic Monochrome], [Rough Monochrome], [Silky Monochrome], [Soft Focus], [Star Filter], [Sunshine])
 - [Monochrome] in [Photo Style]

Modes suited for off-center subjects (49-area-focusing) / , etc. (Custom Multi)

(49-area-focusing)

Subjects in up to 49 AF areas are detected, the focus setting is based on the detected one nearest to the camera.

This function makes it easy to focus on off-center subjects.



- You can customize the focusing area. (→121)

[], etc. (Custom Multi)

From among the 49 AF areas, you can freely set which of them should be used (and which not) for the subject.

1 Press [] (<▲).**2 Select a Custom Multi icon ([], etc.), and then press ▲.**





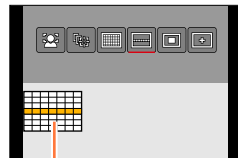

- When you press ▼, the AF area setting screen appears.

3 Use <▶▶ to select the setting item.

- The currently set shape of an AF area is displayed on the bottom-left of the screen.



Current AF area group

 ([Horizontal Pattern])	Horizontal bar Ideal shape for panning, etc.	
 ([Vertical Pattern])	Vertical bar Ideal shape for recording objects, such as buildings.	
 ([User Defined])	Customizable AF area grouping.	
 (Custom)	For registering a customized AF area group.	



4 Press ▼.

- The AF area setting screen appears.

5 Select the AF area.

- Selected AF areas are displayed in yellow, unselected areas in white.

When selecting [] / []

When [] is selected, you can set the size and position of the area in the vertical direction and when [] is selected, in the horizontal direction.

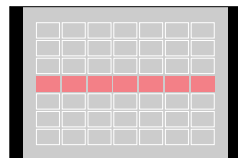

Operation of buttons	Description
▲ ▼ ◀ ▶	Moves position
Control dial	Changes the width (up to three bars)
[DISP] button	Restores to the initial settings

Using Autofocus

When selecting [FREE] / [C1] / [C2] / [C3]

Use ▲▼◀▶ to select the AF area, and then press [MENU/SET] to set (repeat).

- If you press [MENU/SET] again, the setting will be canceled.
- To cancel all the settings, press [DISP].

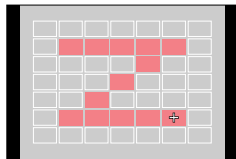
**6 Press [Fn2].****■ Registering the set AF area in [C1], [C2], and [C3] (Custom)**

- ① Press ▲ on the screen of step 3. (→118)
- ② Use ▲▼ to select the registration target icon, and then press [MENU/SET].
 - A confirmation screen is displayed. If you select [Yes], the operation is executed.

- The settings registered in [C1], [C2], or [C3] will be retained even if the camera is turned off.
- The settings in [M], [L], or [FREE] will be restored to the default settings when the camera is turned off.
- If you press a cursor button when [Direct Focus Area] in the [Custom] menu is set to [ON], the AF area setting screen will appear.

▣ (1-area-focusing) / [+] (Pinpoint-focusing)

▣ (1-area-focusing)

The camera focuses on the subject in the AF area in the center of the screen. (Recommended when focusing is difficult, or when it is supposed to be based on a specific off-center detail)

- You can change the position and size of the AF area. (→121)



Locking the focus

If a subject you want to record is not in the center, follow the steps below. (Only when [AFS/AFF/AFC] is set to [AFS])

1 Focus on the subject.

Aim the AF area at the subject



Hold down halfway

Focus display

(When focusing is successful: illuminated
When focusing is not successful: flashes)



AF area

(When focusing is successful: green
When focusing is not successful: red)

2 Return to the desired composition.



Press fully



[+] (Pinpoint-focusing)

Enables more precise focusing on a smaller point than [▣] (1-area-focusing).

- You can set the focus position using the enlarged screen. (→122)
- When you press the shutter button halfway, an enlarged display of the focus position appears.
- You can set the timeout for the enlarged display using [Pinpoint AF Time] in the [Custom] menu. (→122)
- If [+] (Pinpoint-focusing) is selected while recording motion pictures, the setting is changed to [▣] (1-area-focusing).



- [+] (Pinpoint-focusing) is not available when [AFS/AFF/AFC] (→114) is set to [AFF] or [AFC].

Changing the position and size of the AF area

■ When selecting [⦿] / [□]

You can change the position and size of the AF area:

- ① Select [⦿] or [□], and then press ▼.
 - The AF area setting screen appears.
- ② To change the AF area:
 - To move the position of the AF area: Press ▲▼◀▶.
 - To change the size of the AF area: Turn the control dial.
 - If you set the AF area to an eye in the yellow frame when [⦿] is selected, the eye to be used for focusing will be changed.
 - To restore the AF area to its initial state (position)
 - Press [DISP].
- ③ Press [MENU/SET].

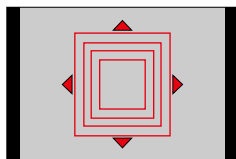

■ When selecting [■]

You can set the focus position by selecting an AF area group.

The 49 AF areas are divided into groups, each consisting of 9 areas (in the screen corners, 6 or 4 areas)

- ① Select [■], and then press ▼.
 - The AF area setting screen appears.
- ② Press ▲▼◀▶ to select an AF area group.
- ③ Press [MENU/SET].
 - Only the [+] indications (center points of the selected group) remain on the screen.
 - To cancel the settings for the AF area frame, press [MENU/SET].

Examples of group

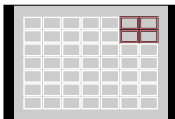
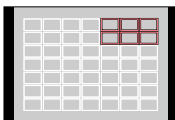
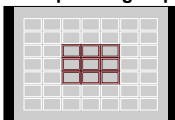

■ When selecting [+]

You can enlarge a section of the image to allow more precise settings of the focus position.

- You cannot set the focus position at the edges of the screen.

- ① Select [+], and then press ▼.
- ② Use ▲▼◀▶ to set the focus position, and then press [MENU/SET].
 - The enlarged assist screen will appear for setting the focus position.
- ③ Move [+] to the focus position with ▲▼◀▶.
 - Pressing [DISP] will bring the focus position back to the center of the assist screen.



Changing the display of the assist screen

MENU →  [Custom] → [Pinpoint AF Display]

[FULL]: Enlarges the assist screen using the entire screen.



[PIP]: Enlarges the assist screen on part of the screen.



- When [PIP] is selected, the size of the screen is enlarged or reduced approximately 3 to 6 times. When [FULL] is selected, it is enlarged or reduced approximately 3 to 10 times. Enlarge or reduce the screen by magnification factors of x1 steps using the control dial.





Setting the timeout for the enlarged display

MENU →  [Custom] → [Pinpoint AF Time] →
 [LONG] (approx. 1.5 seconds) / [MID] (approx. 1.0 seconds) /
 [SHORT] (approx. 0.5 seconds)

- If you release the shutter button, the enlarged display will turn off even before the screen timeout.

Enabling/disabling use of the cursor buttons to move the AF area

MENU →  **[Custom]** → **[Direct Focus Area]** → **[ON] / [OFF]**

When , , or  is selected, you can move the AF area, and when  is selected, you can move the enlarged position.

- When [Custom Multi] such as  is selected, the AF area setting screen is displayed.
- Use the Quick menu (→34) to set functions to be assigned to the cursor buttons, such as [Drive Mode], [White Balance] and [Sensitivity].

- When you set [Metering Mode] (→139) to  (spot-focusing), the metering target will move along with the AF area. When the AF area is moved to the edges of the screen, the metering operation may be affected by the surrounding brightness.



- [Direct Focus Area] is fixed to [OFF] when the picture effect (Filter) is set.
- The position and size of the AF area cannot be changed in the Digital Zoom range.

Setting your preferred focusing method

You can use the [Custom] menu to set the focusing method in detail.



Enabling/disabling focusing when the shutter button is pressed halfway

MENU → **fC** [Custom] → [Shutter AF] → [ON] / [OFF]



Enabling/disabling shutter release when the shutter button is pressed halfway

MENU → **fC** [Custom] → [Half Press Release] → [ON] / [OFF]



Focusing using the [AF/AE] button

You can use the [AF/AE] button instead of the shutter button to start focusing.

1 Set the [Custom] menu.

MENU → **fC** [Custom] → [Shutter AF] → [OFF]

MENU → **fC** [Custom] → [AF/AE Lock] → [AF-ON]

2 Press [AF/AE].

The camera focuses on a subject.

3 Press the shutter button to take a picture.

- The camera takes a picture by adjusting the exposure.

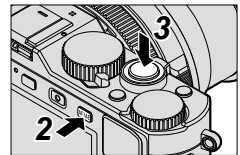

Enabling/disabling pre-focusing

MENU → **fC** [Custom] → [Quick AF] → [ON] / [OFF]

Focusing is automatically started when camera blurring is small even when the shutter button is not pressed. (Increases battery consumption)

- Press the shutter button halfway if focusing is difficult.
- [Quick AF] cannot be used in the following cases:
 - In the [Preview] Mode
 - When the lighting is low

Turning on/off the AF Assist Lamp

MENU →  [Custom] → [AF Assist Lamp] → [ON] / [OFF]

The AF Assist Lamp lights up when the shutter button is pressed halfway when it is too dark to allow focusing. (A large AF area is displayed based on recording conditions.)

- The AF Assist Lamp has an effective range of approx. 1.5m (5 feet).
- The AF Assist Lamp is only effective for a subject in the center of the screen. Remember to position your main subject in the center when the AF-Lamp lights up.
- If you do not want the AF Assist Lamp to light up when you take a picture in a dark location (e.g. taking a picture of an animal in the dark), set this function to [OFF]. When the AF Assist Lamp is set to [OFF], focusing will become difficult.
- The setting is fixed to [OFF] in the following case:
 - When [Silent Mode] is set to [ON]

Enabling/disabling recording when a subject is out of focus

MENU →  [Custom] → [Focus/Release Priority]

[FOCUS]: The shutter release button is locked unless focusing is successful.

[RELEASE]: Releasing the shutter is always possible, regardless of whether the subject is correctly focused or not. This helps to avoid missed opportunities.

- Note that a picture may be out of focus when [RELEASE] is set, even if the focus mode is set to [AFS], [AFF], or [AFC].
- This function is disabled during motion picture recording.

Enabling/disabling manual focusing after AF

MENU →  [Custom] → [AF+MF] → [ON] / [OFF]

You can perform manual focusing during AF Lock (pressing the shutter button halfway when [AFS/AFF/AFC] is set to [AFS] or setting AF Lock using the [AF/AE] button).

Taking Close-Up Pictures

Available in the following modes: **A P A S M**

When you want to render small objects as large as possible, setting to [AF \updownarrow] (AF Macro) enables you to take pictures from an even closer distance than the normal focus range (down to 3cm ($1\frac{3}{16}$ ")) for max. Wide).

1 Move the focus selector switch to [AF \updownarrow].

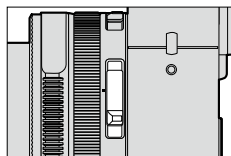

Enables close-up focusing on a subject. (Auto-focus functions.)



Align with the index mark.

Focusing range

Subjects too close to the camera cannot be properly focused.

Shortest focusing distance

The shortest focusing distance is measured from the front of the lens to the subject. This distance changes gradually depending on the set focal length.

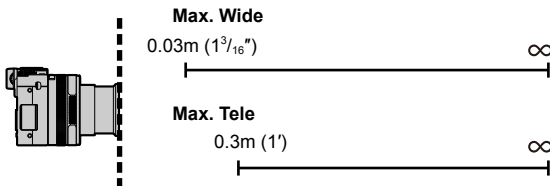

When the focus selector switch is set to [AF \updownarrow] (AF Macro).

Focus selector switch	Zoom	
	Max. Wide	Max. Tele
[AF]	50cm (17")	50cm (17")
[AF \updownarrow] (AF Macro)	3cm ($1\frac{3}{16}$ ")	30cm (1')
[MF] (\rightarrow 128)	3cm ($1\frac{3}{16}$ ")	30cm (1')

Focusing range

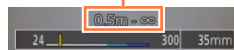

- The focusing range is displayed when setting the focal length (zooming), etc.

Taking Close-Up Pictures

- In [Snapshot Mode], the shortest focusing distance will be the same as that for [AF , regardless of the focus selector switch setting.
- It may take some time until distant subjects come into focus.
- Using a tripod and [Self Timer] is recommended. Also, when photographing a subject close to the camera, we recommend not to use a camera-mounted flash unit.
- Moving the camera after focusing is likely to result in poorly focused pictures if the subject is close to the camera, due to the very small in-focus area.
- The resolution may be reduced at the edges of the picture.

Manual Focusing

Available in the following modes: **A P A S M**

Use this function when you want to lock the focus or when the distance between the lens and the subject remains unchanged for several shots and you do not want to activate Autofocus.

1 Move the focus selector switch to [MF].

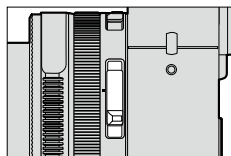

Focus manually on a subject.



Align with the index mark.

2 Press [MENU/SET] / (◀).

3 Press ▲▼◀▶ to determine the area to be enlarged, and then [MENU/SET].

- The screen changes to the assist screen and an enlarged display appears. (MF Assist) (→131)
- If you press [DISP], the area to be enlarged will be reset to the center.

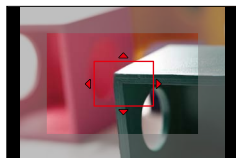

4 Turn the control ring to focus.

Turning the control ring to the right:

Focuses on nearer subjects

Turning the control ring to the left:

Focuses on more distant subjects

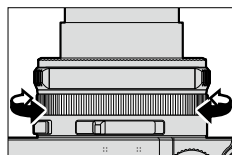

- The edges of in-focus subject parts are highlighted in color. (Peaking) (→130)
- You can check the direction of focusing on the (MF Guide). (→129)

MF Assist
(Enlarged screen)
Peaking

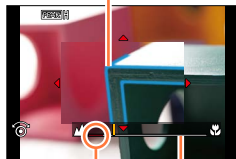

MF Guide
Indicator for ∞ (infinity)

- After changing the focal length (zooming), refocus.
- After canceling [Sleep Mode], be sure to refocus.

Enabling/disabling MF Guide display

MENU →  [Custom] → [MF Guide] → [ON] / [OFF]

Quickly focusing using Autofocus

MENU →  [Custom] → [AF/AE Lock] → [AF-ON]

If you press [AF/AE] in Manual Focus, Autofocus is activated.

- Autofocus is activated at the center of the frame.
- When Autofocus is activated on the MF Assist screen, the camera will focus at the center of the MF Assist screen.

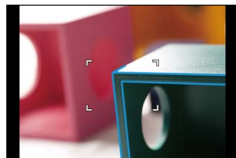



Enabling/disabling the identification of in-focus subject parts [Peaking]

MENU → **/C** [Custom] → **[Peaking]**

- [Peaking] functions during Manual Focus or when you focus manually using [AF+MF].

[ON]	The edges of in-focus subject parts are highlighted in color.																
[OFF]	The function is not active.																
[SET]	[Detect Level]	<p>The detection level for in-focus sections is set. When [HIGH] is set, sections to be highlighted are reduced, allowing you to achieve a more precise focus. Settings: [HIGH] / [LOW]</p> <ul style="list-style-type: none"> • The detection level setting does not affect the focus range. 															
	[Display Color]	<p>Sets the highlighting color used for [Peaking]. Settings The available color settings differ depending on the setting of [Detect Level]. Changing the [Detect Level] setting also changes the [Display Color] setting as follows.</p> <table border="1"> <tr> <td>[Detect Level]</td> <td>[HIGH]</td> <td>↔</td> <td>[LOW]</td> </tr> <tr> <td></td> <td>[] (Light blue)</td> <td>↔</td> <td>[] (Blue)</td> </tr> <tr> <td>[Display Color]</td> <td>[] (Yellow)</td> <td>↔</td> <td>[] (Orange)</td> </tr> <tr> <td></td> <td>[] (Green)</td> <td>↔</td> <td>[] (White)</td> </tr> </table>	[Detect Level]	[HIGH]	↔	[LOW]		[] (Light blue)	↔	[] (Blue)	[Display Color]	[] (Yellow)	↔	[] (Orange)		[] (Green)	↔
[Detect Level]	[HIGH]	↔	[LOW]														
	[] (Light blue)	↔	[] (Blue)														
[Display Color]	[] (Yellow)	↔	[] (Orange)														
	[] (Green)	↔	[] (White)														

- When [Peaking] is set to [ON], [**PEAK H**] ([Detect Level]: [HIGH]) or [**PEAK L**] ([Detect Level]: [LOW]) will be displayed.
- When [Fn Button Set] (→37) in the [Custom] menu is set to [Peaking], you can switch the setting in the following order every time the assigned function button is pressed: [ON] ([Detect Level]: [LOW]) → [ON] ([Detect Level]: [HIGH]) → [OFF].
- The sections with clear outlines highlighted as in-focus on the screen may vary depending on the recording conditions.
- The color used for highlighting does not affect recorded pictures.



The function is not available when the picture effect (Filter) is set ([Rough Monochrome]).

MF Assist

■ The MF Assist display

- Turn the control ring to display MF Assist.
- You can also display MF Assist by pressing ◀ to display the setting screen, pressing the cursor button to set the position to be enlarged, and then pressing [MENU/SET].
- When you perform the following operation, the position to be enlarged will be returned to the center.
 - When you press [DISP] on the screen used for setting of the position to be enlarged
- If you press the cursor button when [Direct Focus Area] in the [Custom] menu is set to [ON], the setting screen for the enlarged position appears.

■ Closing the MF Assist display

- To exit MF Assist, press the shutter button halfway.
- You can also exit MF Assist by pressing [MENU/SET].
- When you display MF Assist by turning the control ring, it is automatically ended approximately 10 seconds after you finish the operation.



- The MF Assist display is disabled in the Digital Zoom range or when recording motion pictures.



Setting the display method of MF Assist

MENU → **/C** [Custom] → [MF Assist]

[]	Turn the control ring or press [] / (◀) to enlarge the position.
[] focus	Turn the control ring to enlarge the position.
[]	Press [] / (◀) to enlarge the position.
[OFF]	The control ring or [] / (◀) cannot be used to enlarge the position.

Changing the MF Assist display

MENU →  [Custom] → [MF Assist Display]

[FULL]: Enlarges the assist section using the entire screen.

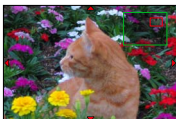

[PIP]: Enlarges the assist section on part of the screen.



- When [PIP] is selected, the MF Assist display is enlarged or reduced approximately 3 to 6 times. When [FULL] is selected, it is enlarged or reduced approximately 3 to 10 times. You can enlarge or reduce the display by magnification factors of x1 steps using the control dial.
-

Focus and Exposure Memory Lock

Available in the following modes: **A P A S M**

This function is useful when you want to take a picture of a subject outside the AF area (AF Lock) and/or for subjects whose brightness is above or below average (AE Lock).

- 1 Aim the AF frame at the main subject (in case it is to be placed off-center), or at an other subject of average brightness (In case it is significantly darker or brighter).**
- 2 Press and hold [AF/AE] to lock the focus and/or exposure settings.**
 - When you release [AF/AE], the focus and/or exposure lock is canceled.
 - Only exposure lock is set at the time of purchase.
- 3 While keeping [AF/AE] pressed, move the camera to compose the picture, and then press the shutter button fully.**
 - When [AE LOCK] is set, press the shutter button halfway to focus, then fully to shoot.

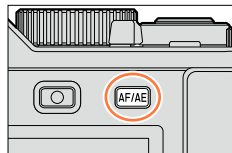

AEL :
Focus is locked (AF Lock)

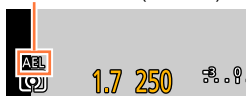

Setting the function of the [AF/AE] button

MENU → **/C** [Custom] → [AF/AE Lock]

[AE LOCK]	Locks exposure only. • [AEL], aperture value, and shutter speed are displayed when the correct exposure is achieved.
[AF LOCK]	Locks focus only. • [AFL], focus, aperture value, and shutter speed are displayed when the subject comes into focus.
[AF/AE LOCK]	Locks focus and exposure. • [AFL], [AEL], focus, aperture value, and shutter speed are displayed when the subject is in focus and the correct exposure is achieved.
[AF-ON]	Autofocus is activated.

Maintaining/not maintaining the lock when [AF/AE] is released

MENU → **/C** [Custom] → [AF/AE Lock Hold] → [ON] / [OFF]

Focus and Exposure Memory Lock

- Only AF Lock is effective when taking pictures in [Manual Exposure] Mode
- Only AE Lock is effective when taking pictures with Manual Focus.
- Only AF Lock is active during motion picture recording. Once you cancel AF Lock during the recording, it cannot be reactivated.
- The subject can be focused again by pressing the shutter button halfway, even when AE is locked.
- Program Shift can be set even when AE is locked.
- Lock is canceled when the focal length is changed after locking the exposure and/or focus. Perform the locking operation again.

Exposure Compensation

Available in the following modes: **A** **P** **A** **S** **M**

Use this function when you wish to modify the exposure settings the camera delivers, e.g. when your main subject would otherwise be rendered brighter/darker than you want.

1 Turn the exposure compensation dial to select the compensation value.

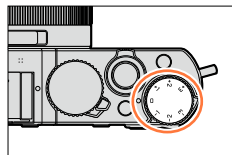

Main subject under-exposed

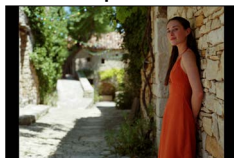

Select a positive compensation value

Optimum exposure

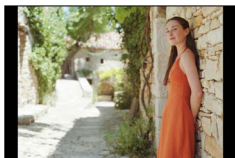

Main subject overexposed

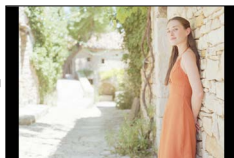

Select a negative compensation value

- You can set the exposure compensation value in the range between -3 EV and $+3$ EV.

- Depending on the brightness, this may not be possible in some cases.
- When [Auto Exposure Comp.] of [Flash] in the [Rec] menu is set to [ON], the flash output is also automatically adjusted based on the exposure compensation value. (→184)

Setting the ISO Sensitivity

Available in the following modes: **A P A S M**

This allows the sensitivity to light (ISO sensitivity) to be set. Higher values allow using faster shutter speeds e.g. for unblurred hand-held shots and/or higher aperture values e.g. for more depth of field.

1 Press [ISO] / (▲).

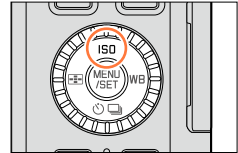

2 Turn the control dial to select the ISO Sensitivity, and then press [MENU/SET].



AUTO	ISO sensitivity is automatically set in a range up to 3200* ¹ depending on the brightness of a subject.
ISO (Intelligent ISO)	ISO sensitivity is automatically set in a range up to 3200* ¹ depending on the movement and brightness of a subject.
100*²/200/400/800/1600/3200/6400/12500/25000	ISO sensitivity is fixed at the selected setting. • When [ISO Increments] is set to [1/3EV], the number of available ISO sensitivity increments will increase. (→138)

*¹ When [ISO Limit Set] (→137) in the [Rec] menu is set to anything other than [OFF], the ISO sensitivity is automatically set in the range up to the [ISO Limit Set] setting value.

*² Only when [Extended ISO] is [ON].



Setting guide

Sensitivity	[200] ←→ [25000]
Recommended situation	When it is bright (outdoors) When it is dark
Shutter speed	Slower Faster
Noise	Less More
Subject blurring	More Less

Setting the ISO Sensitivity

- When [High Dynamic] is selected for the picture effect (Filter), [Sensitivity] is fixed to [AUTO].
- When a picture effect (Filter) other than [High Dynamic] is selected or when [Multi Exp.] is set, ISO Sensitivity can be set in a range up to [3200].
- For details on the available flash range used when the [Sensitivity] is set to [AUTO], refer to (→178).
- [ISO] cannot be selected in the following cases:
 - [Shutter-Priority] Mode
 - [Manual Exposure] Mode
- When [Direct Focus Area] (→123) is set to [ON], the cursor buttons function as an operation for moving the AF area. In that case, use the Quick menu (→34) to set the ISO Sensitivity.
- You can use the following settings when recording motion pictures:
[AUTO], [200] - [6400]

Setting the upper ISO sensitivity limit

Available in the following modes: **A P A S M**

You can set the upper limit of ISO Sensitivity when [Sensitivity] is set to [AUTO] or [ISO].

MENU →  **[Rec]** → **[ISO Limit Set]**

Settings: [400] / [800] / [1600] / [3200] / [6400] / [12500] / [25000] / [OFF]



The function is not available during motion picture recording.

Setting the ISO Sensitivity

Setting the ISO sensitivity setting increments

Available in the following modes: **A** **P** **A** **S** **M**

You can determine whether to set the ISO values in 1 EV or 1/3 EV steps.

MENU →  **[Rec]** → **[ISO Increments]**

[1/3EV]	[L.100]* / [L.125]* / [L.160]* / [200] / [250] / [320] / [400] / [500] / [640] / [800] / [1000] / [1250] / [1600] / [2000] / [2500] / [3200] / [4000] / [5000] / [6400] / [8000] / [10000] / [12500] / [16000] / [20000] / [25000]
[1 EV]	[L.100]* / [200] / [400] / [800] / [1600] / [3200] / [6400] / [12500] / [25000]

* Only when [Extended ISO] is [ON].

- When this setting is changed from [1/3EV] to [1 EV], the setting for [Sensitivity] may be changed. (The closest ISO Sensitivity that can be set for [1 EV] will be used.)

Extending the ISO sensitivity setting

Available in the following modes: **A** **P** **A** **S** **M**

This mode allows setting the ISO sensitivity up to [25000].

MENU →  **[Rec]** → **[Extended ISO]**



Settings: [ON] / [OFF]

Selecting the Exposure Metering Mode [Metering Mode]

Available in the following modes: **A P A S M**

You can select between three different brightness metering methods.

MENU →  **[Rec]** → **[Metering Mode]**

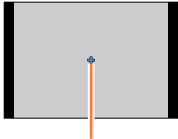
[Metering Mode]	Brightness measurement position	Conditions
 (Multiple)	The brightness is detected in different sections of the frame. The exposure is then based on the probable main subject	Normal usage (high probability of automatically correctly exposed main subjects even with greater brightness differences)
 (Center weighted)	The metering sensitivity is concentrated on the center while also registering the rest of the frame	Use when subject is in the center, or to deliberately base the exposure on an off-center subject (provided, subject is of medium brightness)
 (Spot)	Center of [+] (spot metering target)  Spot metering target	Use to base the exposure on very small subject parts (provided, these parts are of medium brightness)

- The menu item is common for both the [Rec] and [Motion Picture] menus. If a setting in one menu is changed, the setting with the same name in other menu will also be changed automatically.

Setting the Shutter Type

Available in the following modes: **A P A S M**

You can use either of the two shutter types to take pictures: the mechanical and the electronic shutter.

	Mechanical shutter	Electronic shutter
Description	Starts the exposure electronically and ends it using the mechanical shutter.	Starts and ends the exposure electronically.
Flash	○	—
Shutter speeds	60 - 1/4000s	1*1 - 1/16000s
Shutter sound	Mechanical shutter sound*2 + Electronic shutter sound*3	Electronic shutter sound*3

*1 You can set ISO Sensitivity up to [ISO 3200]. When ISO Sensitivity is higher than [ISO 3200], the shutter speed will be faster than 1 second.

*2 You cannot avoid the mechanical shutter sound.

*3 You can use [Shutter Vol.] to adjust the volume of the electronic shutter sound. (→43)

1 Set the menu item

MENU →  **[Rec]** → **[Shutter Type]**

[AUTO]	The shutter mode automatically switches based on the recording conditions and shutter speed. • The mechanical shutter mode has higher priority over the electronic shutter mode because the mechanical shutter has less function-related restrictions, e.g. when recording with a flash.
[MSHTR]	Only the mechanical shutter is used.
[ESHTR]	Only the electronic shutter is used.

- When [E] is displayed on the screen, the electronic shutter is used.
- When [Burst Rate] is set to [SH], the electronic shutter is used.
- When [Silent Mode] is set to [ON], the electronic shutter is used.
- **If you take a picture of a moving subject using the electronic shutter, the subject in the picture may be skewed in some cases.**
- **When you take a picture under a fluorescent or LED lighting fixtures using the electronic shutter, the recorded picture may be reduced.** (→84)
- **Remember not to exploit this function in situations where it may violate the privacy, likeness rights, etc. of the targeted subject. Use at your own risk.**

Selecting a Drive Mode

Available in the following modes: **A P A S M**

You can change what the camera will do when you press the shutter button.

1 Press [] / ().

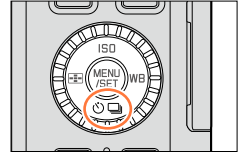

2 Press to select the drive mode, and then [**MENU/SET**].

Drive Mode

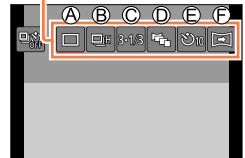

A [Single]	When the shutter button is pressed, only one picture is taken.
B [Burst] (→142)	Pictures are taken in succession as long as the shutter button is pressed.
C [Auto Bracket]* (→145)	Each time the shutter button is pressed, a series of pictures is taken with different exposure settings according to the selected interval.
D [Aspect Bracket]* (→147)	When the shutter button is pressed, 4 pictures with 4 different aspect ratios are automatically recorded.
E [Self Timer] (→148)	When the shutter button is pressed, the picture is taken after the set time has elapsed.
F [Panorama Shot]* (→150)	Exposures are recorded in succession while you press the shutter button and move the camera horizontally or vertically. After that the camera combines them into a single panorama picture.

* This mode is not available when using [Snapshot Mode].



- To cancel drive mode, select [] ([Single]) or [] ([Off]). The recording is switched to "Single".
- When you press , you can change the settings of each drive mode. Note, however, that you cannot change the settings of [Single] and [Aspect Bracket].



Using Continuous Mode

Available in the following modes: **[A] [P] [A] [S] [M]**

Pictures are taken in succession as long as the shutter button is pressed.

- Pictures that are taken while [Burst Rate] is set to [SH] are recorded together as a single picture group (→198).

1 Press **[ ] / []**.

2 Press **◀▶** to select the continuous icon (**[ ]**, etc.), and then **▲**.

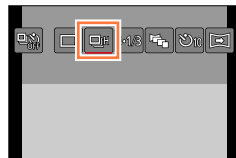

3 Press **◀▶** to select the frame rate, and then **[MENU/SET]**.



Frame Rate		[SH] (Super high speed)*1	[H] (High speed)	[M] (Middle speed)	[L] (Low speed)
Pictures/ second	[AFS]	40	11	7	2
	[AFF] / [AFC]	—	6.5	6.5	2
Live View during Continuous Mode		None	None	Available	Available
No. of pictures*2	With RAW files	—	20*3	20*3	20*3
	Without RAW files	60	Depends on the capacity of the card*3		

*1 The electronic shutter will be activated.

*2 The number of pictures is limited by the picture-taking conditions and the type and/or status of the card used.

*3 Pictures can be taken until the card becomes full. However, the frame rate will become slower halfway through the recording. The exact timing of this depends on the aspect ratio, the resolution, and the quality as well as the type of card used.

- The frame rate may become slower depending on the following settings:
 - [Picture Size] (→108), [Quality] (→109), Sensitivity (→136), Focus mode (→114), [Focus/Release Priority] (→125)
- The frame rate can also be set with [Burst Rate] in the [Rec] menu.
- For information about RAW files, refer to (→109).

Using Continuous Mode

4 Focus on the subject and take a picture.

- Hold down the shutter button fully to activate Continuous Mode.

**■ To cancel Continuous Mode**

In step **2**, select [] ([Single]) or [OFF].

**Focusing in Continuous Mode**

Focusing varies depending on the focus mode (→114) and the setting of [Focus/Release Priority] (→125) in the [Custom] menu.

Focus mode	[Focus/Release Priority]	Focusing
[AFS]	[FOCUS]	At the first picture
	[RELEASE]	
[AFF] / [AFC]*1	[FOCUS]	Normal focusing*2
	[RELEASE]	Predicted focusing*3
[MF]	—	Focus set with Manual Focus

*1 Focus is fixed in the first picture when dark subjects are recorded or the frame rate is set to [SH].

*2 The frame rate may become slower because the camera is continuously focusing on the subject.

*3 The frame rate takes priority, and focus is estimated within possible range.

Using Continuous Mode

- When the frame rate is set to [H] and if many pictures are taken, the frame rate may be reduced during the series.
- When the frame rate is set to [SH] or [H] (the focus mode is set to [AFS] or [MF]), and the exposure and White Balance settings are fixed to those of the first picture.
When the frame rate is set to [H] (the focus mode is set to [AFF] or [AFC]), [M], or [L], and the exposure and White Balance settings are adjusted individually for each still picture.
- The frame rate may be reduced if the shutter speed is reduced in darker locations.
- With repeated recordings, it may take a while between recordings, depending on the usage conditions.
- **It may take a while to store still pictures that were taken using Continuous Mode. If you continue to record while storing, the number of pictures that can be taken will be reduced. A high-speed card is recommended when recording using Continuous Mode.**



- Continuous Mode is disabled in the following cases:
 - When the picture effect (Filter) is set ([Rough Monochrome], [Silky Monochrome], [Miniature Effect], [Soft Focus], [Star Filter], [Sunshine])
 - When White Balance Bracket is set
 - When using [Time Lapse Shot]
 - When using [Stop Motion Animation] (only available with [Auto Shooting] setting)
 - During motion picture recording
 - When [4K PHOTO] is set to [ON]
 - When recording using the flash
 - When recording with [iHandheld Night Shot]
 - During T (time) recording
 - When [HDR] is set to [ON]
 - When [Multi Exp.] is set
 - When [Simultaneous record w/o filter] is set to [ON]
- [SH] in Continuous Mode cannot be used in the following cases:
 - When [Quality] is set to [RAW], [RAW] or [RAW]
 - When using [Stop Motion Animation]



Using [Auto Bracket]



Available in the following modes: **A P A S M**

In this mode, up to a maximum of 7 pictures are automatically taken with the selected exposure steps.

Example of Auto Bracket recording when [Step] is set to [3·1/3] and [Sequence] is set to [0/-/+]



1 Press [] / [] / [].

2 Press   to select the Auto Bracket icon ([3·1/3], etc.), and then .

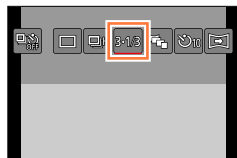

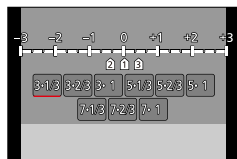

3 Press   to select the compensation range, and then [MENU/SET].



4 Focus on the subject and take a picture.

- If you press and hold the shutter button, the number of pictures that you had set is taken.
- The Auto Bracket indication flashes until the number of pictures that you had set is taken
- The camera restarts recording from the first still picture if you change the Auto Bracket settings or turn off the camera before all of the pictures you had set are recorded.

■ To cancel [Auto Bracket]

In step **2**, select [] ([Single]) or [] ([Off]).

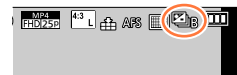

■ Changing the Single/Continuous setting, the compensation range, and the recording sequence of Auto Bracket

① Set the menu item:

MENU →  **[Rec]** → **[Auto Bracket]**

② Press **▲▼** to select [Single/Burst Settings], [Step] or [Sequence], and then [MENU/SET].

③ Press **▲▼** to select the setting, and then [MENU/SET].

[Single/Burst Settings]	<input type="checkbox"/>	(single)
		(burst)

[Step]	3·1/3	(3 pictures)
	3·2/3	(3 pictures)
	3·1	(3 pictures)
	5·1/3	(5 pictures)
	5·2/3	(5 pictures)
	5·1	(5 pictures)
	7·1/3	(7 pictures)
7·2/3	(7 pictures)	
7·1	(7 pictures)	

[Sequence]	0/~/+
	-/0/+

- You can take one picture at a time when is set.
- A series of pictures can be recorded up to the number of pictures you have set when  is set.
- Close the menu after changing settings.

- When you take pictures using Auto Bracket after setting an exposure compensation, the camera will base the series on the compensated exposure.







- [Auto Bracket] is disabled in the following cases:
 - When the picture effect (Filter) is set ([Rough Monochrome], [Silky Monochrome], [Miniature Effect], [Soft Focus], [Star Filter], [Sunshine])
 - When White Balance Bracket is set
 - During motion picture recording
 - When [4K PHOTO] is set to [ON]
 - When recording using the flash
 - During T (time) recording
 - When [HDR] is set to [ON]
 - When [Multi Exp.] is set
 - When using [Time Lapse Shot]
 - When using [Stop Motion Animation] (only available with [Auto Shooting] setting)
 - When [Simultaneous record w/o filter] is set to [ON]

Using Aspect Bracketing

Available in the following modes: **A P A S M**

When you press the shutter button once, the camera automatically takes four pictures with four different aspect ratios (4:3, 3:2, 16:9, and 1:1). (The shutter sounds only once.)

1 Press **[ ]** / **[]**.

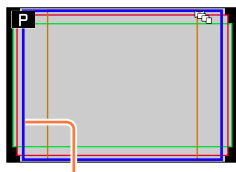

2 Press **[ ]** to select the aspect bracket icon (**[ ]**), and then **[MENU/SET]**.



The area that is recorded for each aspect ratio is displayed.



3 Focus on the subject and take the picture.

■ To cancel Aspect Bracketing

In step **2**, select **[]** ([Single]) or **[ OFF]**.

- When [Picture Size] is set to [S], the setting is automatically changed to [M].
- The same shutter speed, aperture value, focus, [Exposure], [White Balance], and [Sensitivity] settings are used for all four pictures.







- [Aspect Bracket] is disabled in the following cases:
 - When the picture effect (Filter) is set ([Rough Monochrome], [Silky Monochrome], [Toy Effect], [Toy Pop], [Miniature Effect], [Soft Focus], [Star Filter], [Sunshine])
 - During motion picture recording
 - When [4K PHOTO] is set to [ON]
 - During T (time) recording
 - When White Balance Bracket is set
 - When [Quality] is set to [RAW , [RAW , or [RAW]
 - When using [Time Lapse Shot]
 - When using [Stop Motion Animation] (only available with [Auto Shooting] setting)
 - When [HDR] is set to [ON]
 - When [Multi Exp.] is set
 - When [Simultaneous record w/o filter] is set to [ON]

Using the Self-Timer

Available in the following modes: **[A] [P] [A] [S] [M]**

We recommend using a tripod and the self-timer's 2 second delay to prevent camera shake caused by pressing the shutter button.

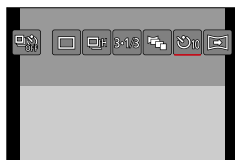

1 Press **[ ] / []**.

2 Press **◀▶** to select the self-timer icon (**[₁₀]**, etc.), and then **▲**.



3 Press **◀▶** to select the self-timer operation setting, and then **[MENU/SET]**.



	The shutter is tripped after 10 seconds.
	The shutter is tripped after 10 seconds and three pictures are taken at intervals of approximately 2 seconds.
	The shutter is tripped after 2 seconds.

- You can also set the time for the self-timer using [Self Timer] in the [Rec] menu.

4 Press the shutter button halfway to focus, then fully to start recording.

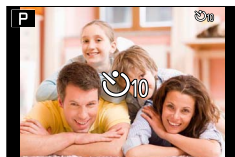

- The focus and exposure settings are fixed when the shutter button is pressed halfway.

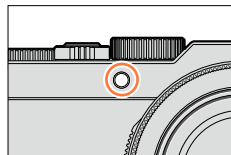

- After the self-timer indicator flashing stops, the picture(s) will be taken.



■ To cancel the self-timer

In step **2**, select **[]** ([Single]) or **[]**.

- You can cancel the self-timer by turning off the camera. (When [Self Timer Auto Off] (→50) is set to [ON].)

Using the Self-Timer

- If you take a picture with a flash attached and switched on when [☺] is set, the flash output may not be consistent in some cases.



- This mode cannot be set to [☺] in the following cases:
 - When White Balance Bracket is set
 - When [Multi Exp.] is set
 - During T (time) recording
- The self-timer is disabled in the following cases:
 - During motion picture recording
 - When [4K PHOTO] is set to [ON]
 - When using [Time Lapse Shot]
 - When using [Stop Motion Animation] (only available with [Auto Shooting] setting)

Creating Panorama Pictures

Available in the following modes: **A P A S M**

You can easily create a panorama picture with this mode by panning the camera while it takes pictures continuously. When the series is finished, the recordings are automatically combined into one panorama picture.

- 1 Press [] / ().
- 2 Press to select the panorama icon (, etc.), and then .
- 3 Press to select the recording direction, and then [MENU/SET].

Left → Right	A horizontal guide line is displayed.
Right → Left	
Down → Up	A vertical guide line is displayed.
Up → Down	

- You can also select the recording direction using [Panorama Direction] in the [Rec] menu.



Applying a picture effect (Filter)

- ① Press [F] to select a picture effect. (→89)
 - Ⓐ Recording direction
 - Ⓑ Picture effects
(This is not displayed when [No Effect] is selected.)
 - Ⓒ Adjusting the picture effect
(This is only displayed when a picture effect is selected.)
 - You can also set the picture effects by turning the control ring.
 - [Toy Effect], [Toy Pop], [Miniature Effect], and [Sunshine] are not available.
 - When recording panorama pictures, the following effects are not applied to the recording screen.
 - [Rough Monochrome], [Silky Monochrome], [Soft Focus], [Star Filter]
- ② Press [MENU/SET].

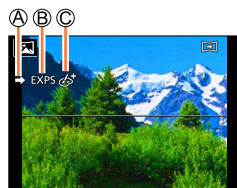

- 4 Press the shutter button halfway to focus.

5 Press the shutter button fully and pan the camera in a small circular motion to the recording direction to start recording.

Taking pictures from left to right



Panning direction and progress status (approximation)

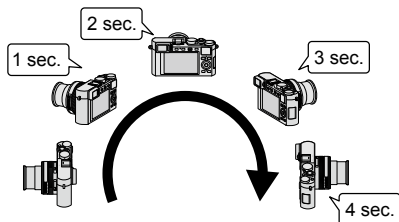

- Pan the camera at a constant speed.
- You may not be able to take pictures successfully if you move the camera too quickly or too slowly.

6 Press the shutter button fully again to end recording.

- You can also end recording if you stop panning the camera during the process.
- Recording can also be ended by moving the camera to the end of the guide.



Tips

- Pan the camera in the respective direction as steadily as possible.

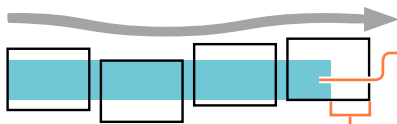

If the camera shakes too much, it may not be able to take pictures or may end up creating a narrow (small) panorama picture.

Pan the camera to a point slightly further than where you want the edge of the picture to be. (However, the last frame is not recorded to the end.)



Creating Panorama Pictures

■ About panorama picture playback

Panorama pictures can be enlarged by operating the zoom lever the same way as with other still pictures. If you play back panorama pictures in the same way as playing back a motion picture, the panorama pictures are scrolled automatically. (→70)



- Unlike motion picture playback, you cannot perform fast forward or fast rewind while the panorama pictures are scrolling automatically. (You can perform single-frame forward or rewind while the automatic scrolling operation is paused.)

■ To cancel

In step **2**, select  ([Single]) or  ([Off]).

- The lens is fixed to its shortest focal length.
- [Stabilizer] does not work when it is set to  (Normal).
- Since the aperture value and the shutter speed are automatically controlled during panorama picture recording, settings made by the aperture ring or shutter speed dial are disabled.
- The focus, exposure and White Balance settings are all fixed to optimal values for the first picture. If the focusing or brightness of pictures recorded as part of a panorama picture after the first picture are significantly different from those of the first picture, the panorama picture as a whole (when all pictures are stitched together) may not have consistent focus and brightness.
- When the picture effect (Filter) is set, [White Balance] is fixed to [AWB].
- Since several pictures are stitched together to create a panorama picture, some subjects may be distorted or the joining areas may be noticeable.
- The resolution per horizontal line and vertical line of a panorama picture varies depending on the panning direction and the number of stitched pictures.
The maximum resolution is as follows:
 - Taking pictures in landscape orientation: approx. 8176×1920
 - Taking pictures in portrait orientation: approx. 2560×7680
- [Shutter Type] is fixed to [AUTO].



- You cannot create a panorama picture in the following cases:
 - When White Balance Bracket is set
 - When [Quality] is set to [RAW , [RAW ] or [RAW]
 - When [HDR] is set to [ON]
 - When [Multi Exp.] is set
 - During T (time) recording
 - When using [Time Lapse Shot]
 - When using [Stop Motion Animation]
 - When [Silent Mode] is set
 - When the [Simultaneous record w/o filter] is set to [ON]
 - When [4K PHOTO] is set to [ON]
- Panorama pictures may not be created or pictures may not be recorded properly in the case of the following subjects or the following recording conditions:
 - Subjects containing larger uniform areas or patterns (sky, beach, etc.)
 - Moving subjects (person, pet, vehicle, waves, or flowers swaying in the wind, etc.)
 - Subjects whose colors or patterns change quickly (such as an image appearing on a display)
 - Dark locations
 - Locations with flickering light sources (fluorescent lamp, candle light, etc.)

Taking Pictures Automatically at Set Intervals [Time Lapse Shot]

4 Press the shutter button fully.

- The recording starts automatically.
- During recording standby, the camera turns off automatically when no operation is performed for a preset interval. The [Time Lapse Shot] recording will continue even if the camera is turned off, and the camera is automatically turned on at the recording start time. If you want to turn on the camera manually, press the shutter button halfway.
- When you press [Fn2] while the camera is turned on, the pause or end selection screen will appear. Perform the operation based on the instructions on the screen. When you press [Fn2] while the camera is in the pause state, the restart or end selection screen will appear. You can also restart the operation from the pause state by fully pressing the shutter button.
- When a confirmation screen for continuing the creation of a motion picture is displayed, select [Yes].

5 Select the motion picture creation method.

[Rec Quality]	Sets the picture quality of the motion picture. <ul style="list-style-type: none"> • With camera models 18 471 / 18 472: [4K/30p] / [4K/24p] / [FHD/60p] / [FHD/30p] / [HD/30p] / [VGA/30p] • With camera models 18 470 / 18 473: [4K/25p] / [4K/24p] / [FHD/50p] / [FHD/25p] / [HD/25p] / [VGA/25p]
[Frame Rate]	Set the number of frames per second. When you set a higher number, you can create a more seamless stop motion animation. <ul style="list-style-type: none"> • With camera models 18 471 / 18 472: [60fps]*¹ / [30fps] / [15fps] / [10fps] / [7.5fps] / [6fps] / [3fps] / [1fps] • With camera models 18 470 / 18 473: [50fps]*² / [25fps] / [12.5fps] / [8.3fps] / [6.25fps] / [5fps] / [2.5fps] / [1fps] <p>*¹ Only available with [FHD/60p] setting *² Only available with [FHD/50p] setting</p> <ul style="list-style-type: none"> • You can set the number of frames to [24fps], [12fps], [8fps], [6fps], [4.8fps], [2.4fps], or [1fps] when [Rec Quality] is set to [4K/24p].
[Sequence]	[NORMAL]: Stitches the pictures in the recording sequence. [REVERSE]: Stitches the pictures in the reverse order of recording.

6 Use ▲ ▼ to select [OK], and then press [MENU/SET].

- A confirmation screen is displayed. If you select [Yes], the operation is executed.
- You can also create a motion picture using [Time Lapse Video] in the [Playback] menu. (→212)

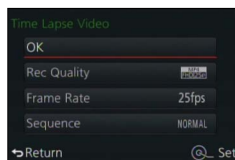

Taking Pictures Automatically at Set Intervals [Time Lapse Shot]

- This function is not intended for application-specific systems (monitoring cameras).
- **If you leave the camera unattended during [Time Lapse Shot] recording, make sure it cannot be stolen.**
- **Exercise caution when you perform [Time Lapse Shot] recording for a long period of time in cold regions or in a low-temperature or high-temperature/high-humidity environment, since such use could cause malfunctions.**

- The camera may not be able to record using the preset interval and number of pictures to be recorded under some recording conditions.

- Use a sufficiently charged battery.

- [Time Lapse Shot] is paused in the following cases:

- When the remaining battery power runs out
- When the camera is turned off

If this occurs during [Time Lapse Shot] recording, you can restart the operation by replacing the battery or card in the pause state and turning the camera [ON/OFF] switch to [ON]. (Note, however, that the pictures recorded after restarting the operation are saved as another group picture.) When you replace the battery or card, turn the camera [ON/OFF] switch to [OFF].

- Do not connect an AV or an HDMI micro cable or the supplied USB cable during [Time Lapse Shot] recording.

- When you select the picture quality for an aspect ratio that is different from the original picture, the picture will be displayed with a black band on the upper/lower side or the left/right side of a stop motion animation.

- The maximum time for a time lapse video is 29 minutes, the maximum file size 4GB.

- When a stop motion animation is shorter than 2 seconds, "2s" will be displayed for the motion picture recording time (→70).

- When the number of recorded pictures is one, it will not be saved as a group picture.



- [Time Lapse Shot] cannot be used in the following cases:

- During panorama picture recording
- When [Multi Exp.] is set
- When using [Stop Motion Animation]
- When the [Simultaneous record w/o filter] is set to [ON]

Creating Stop Motion Pictures [Stop Motion Animation]

Available in the following modes: **A P A S M**

A stop motion picture is created by splicing pictures together.

- **Complete the date and time settings in advance.** (→29)
- Still pictures that were captured using frame-by-frame recording are grouped into a single picture group. (→198)



Before creating a motion picture with [Stop Motion Animation]

With [Stop Motion Animation], you can create a motion picture in which objects appear to be moving by taking a still picture each time you move them in small increments, and then splicing the recordings together.

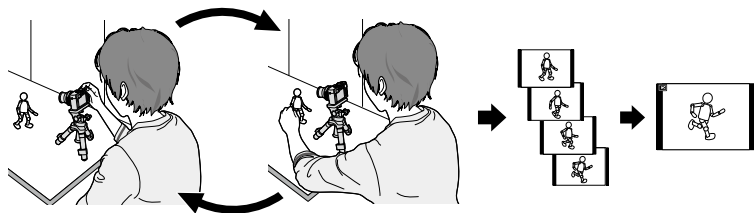

● **With camera models 18 471 / 18 472:**

The resulting motion pictures can have frame rates of 1 to 60fps, i.e. you can take 1 to 60 still pictures for every 1 second of motion picture.

● **With camera models 18 470 / 18 473:**

The resulting motion pictures can have frame rates of 1 to 50fps, i.e. you can take 1 to 50 still pictures for every 1 second of motion picture.

- For smoother motion, record movement using as many frames as possible and a high frame rate.

1 Set the menu item:

MENU → **[Rec]** → **[Stop Motion Animation]**

Creating Stop Motion Pictures [Stop Motion Animation]

2 Press ▲▼ to select the recording method, and then [MENU/SET].

[Auto Shooting]	[ON]	Takes pictures automatically at a set recording interval. When the shutter button is pressed fully, recording starts.
	[OFF]	Takes pictures manually, one frame at a time.
[Shooting Interval]	(Available only when [Auto Shooting] is set to [ON]) Sets the interval used for [Auto Shooting]. You can set the interval from 1 second to 60 seconds in 1-second intervals. Press ◀▶ to select the interval (seconds), ▲▼ to set the selected time, and then [MENU/SET].	

3 Press ▲▼ to select [Start], and then [MENU/SET].**4 Press ▲▼ to select [New], and then [MENU/SET].****5 Press the shutter button fully.**

- Up to 9,999 frames can be recorded.

6 Move the subject according to the intended composition.

- Repeat the recording of the other pictures in the same way.
- When you turn off the camera during recording, a message to restart recording will appear when you turn on the camera. To start recording from the next still picture, select [Yes].

**How to create stop motion animation effectively**

- Up to two previously recorded pictures are displayed on the recording screen. Check this screen as a guideline for determining the amount of required motion.
- You can press [▶] to check the recorded pictures. Press [⏪/↶] to delete unnecessary pictures. To return to the recording screen, press [▶] again.

Creating Stop Motion Pictures [Stop Motion Animation]

7 Press [MENU/SET] to end recording. Next, select [Stop Motion Animation] in the [Rec] menu, and then press [MENU/SET] again.

- A confirmation screen is displayed. It is ended when [Yes] is selected.
- A confirmation screen for creating a motion picture is displayed next, so select [Yes].

8 Select a method to create a stop motion animation.

[Rec Quality]	Sets the resolution of the motion picture. <ul style="list-style-type: none"> • With camera models 18 471 / 18 472: [4K/30p] / [4K/24p] / [FHD/60p] / [FHD/30p] / [HD/30p] / [VGA/30p] • With camera models 18 470 / 18 473: [4K/25p] / [4K/24p] / [FHD/50p] / [FHD/25p] / [HD/25p] / [VGA/25p]
[Frame Rate]	Sets the number of frames per second. Higher frame rates result in smoother motion. <ul style="list-style-type: none"> • With camera models 18 471 / 18 472: [60fps]*1 / [30fps] / [15fps] / [10fps] / [7.5fps] / [6fps] / [3fps] / [1fps] • With camera models 18 470 / 18 473: [50fps]*2 / [25fps] / [12.5fps] / [8.3fps] / [6.25fps] / [5fps] / [2.5fps] / [1fps] <p>*1 Only available with [FHD/60p] setting *2 Only available with [FHD/50p] setting</p> <ul style="list-style-type: none"> • You can set the number of frames to [24fps], [12fps], [8fps], [6fps], [4.8fps], [2.4fps], or [1fps] when [Rec Quality] is set to [4K/24p].
[Sequence]	[NORMAL]: Splices the still pictures in the recording sequence. [REVERSE]: Splices the still pictures in the reverse order of recording.

9 Press ▲ ▼ to select [OK], and then [MENU/SET].

- A confirmation screen is displayed. If you select [Yes], the operation is executed.
- You can also create a stop motion animation using [Stop Motion Video] in the [Playback] menu. (→212)

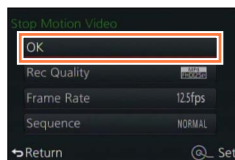

■ Adding pictures to an already recorded stop motion animation group

When you select [Additional] in step 4, group pictures recorded using [Stop Motion Animation] are displayed. Select a group picture and press [MENU/SET]. Then, select [Yes] on the confirmation screen.

Creating Stop Motion Pictures [Stop Motion Animation]

- [Auto Shooting] may not be performed according to the preset interval because recording may take time under some conditions, such as when pictures are taken using a flash.
- When you select the resolution for an aspect ratio that is different from the original picture, the picture will be displayed with a black band on the upper/lower or the left/right side of a stop motion animation.
- When you select the resolution for an aspect ratio that is different from the original picture, this will produce grainy pictures in a stop motion animation.
- Use a sufficiently charged battery.
- The maximum time for a stop motion animation video is 29 minutes, the maximum file size 4GB.
- When a stop motion animation is shorter than 2 seconds, "2s" will be displayed for the motion picture recording time (→70).
- If only one still picture is recorded, it will not be recorded as a group picture. You cannot select only one recorded still picture using [Additional].



- [Stop Motion Animation] cannot be used in the following cases:
 - During panorama picture recording
 - When [Multi Exp.] is set
 - When using [Time Lapse Shot]
 - When the [Simultaneous record w/o filter] is set to [ON]

Making Multiple Exposures for a Single Picture

[Multi Exp.]

Available in the following modes: **A P A S M**

You can create pictures in which several exposures (up to 4) are superimposed over each other.

1 Set the menu item:

MENU →  [Rec] → [Multi Exp.]

2 Press ▲▼ to select [Start], and then [MENU/SET].

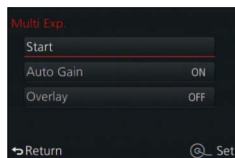

3 Decide on your composition and take the first picture.

- After recording the first picture, press the shutter button halfway to proceed to the next recording.
- Press ▲▼ to select the item, and then [MENU/SET]. You can perform the following operations.
 - [Next]: Proceed to the next recording.
 - [Retake]: Delete the last shot and take another picture.
 - [Exit]: Exit Multi Exposure and save the picture that was taken.

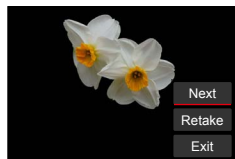

4 Record the second, third, and fourth pictures.

- When you press [Fn1] while taking pictures, the pictures that you took are saved and Multi Exposure is closed.

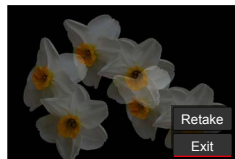

5 Press ▼ to select [Exit], and then [MENU/SET].

- You can also end the operation by pressing the shutter button halfway.

Making Multiple Exposures for a Single Picture [Multi Exp.]

■ About the automatic gain compensation setting

Select [Auto Gain] on the screen in step **2** (→160).

- **[ON]:** The brightness level is adjusted according to the number of pictures taken.
- **[OFF]:** The brightness levels of the individual exposures are not changed. If desired, i.e. if the subject calls for it, adjust the exposures accordingly.

■ To overlay the pictures on the RAW file picture on a card

Set [Overlay] to [ON] on the screen in step **2** (→160). After [Start], the pictures on a card will be displayed. Select the RAW file pictures and press [MENU/SET] to continue recording.

- You can perform [Overlay] on RAW file pictures recorded using this camera only.

- Pictures are not saved in memory until Multi Exposure is ended.
- Information for the picture taken last will be used as recording information of pictures taken using Multi Exposure.
- While [Multi Exp.] recording is being performed, you cannot set items displayed in gray on the menu screen.



- [Multi Exp.] cannot be used in the following cases:
 - When the picture effect (Filter) is set
 - During panorama picture recording
 - When using [Time Lapse Shot]
 - When using [Stop Motion Animation]

Disabling Operational Sounds and the Light Sources at the Same Time [Silent Mode]



Available in the following modes: **A P A S M**

This function is useful for taking pictures in a quiet environment or public facilities or when you take pictures of a subject such as a baby or an animal.

1 Set the menu item:

MENU → **/C** [Custom] → [Silent Mode]

Settings: [ON] / [OFF]

- Operational sounds are muted, and an attached flash and the AF Assist lamp are switched off. The settings for the following functions are fixed:
 - [Shutter Type]: [ESHTR]
 - [Flash Mode]: [] (Forced Flash Off)
 - [AF Assist Lamp]: [OFF]
 - [Beep Volume]: [] (Off)
 - [Shutter Vol.]: [] (Off)

- Even when this mode is set to [ON], the following lamps/indicators will light up or flash.
 - Self-timer indicator
 - Wi-Fi connection lamp
- The operation sounds such as when the aperture or the focal length is changed are not muted.
- **Remember not to exploit this function in situations where it may violate the privacy, likeness rights, etc. of the targeted subject. Use at your own risk.**

Using the Face Recognition Function [Face Recog.]

Available in the following modes: **[A] [P] [A] [S] [M]**

Face Recognition is a function which identifies a face if it resembles a registered face and prioritizes focus and exposure settings on that face automatically. Even if the person is located towards the back or at the edge in a group photo, the camera will still render the identified face in focus.

1 Set the menu item:

MENU → **[Rec]** → **[Face Recog.]**

Settings: **[ON]** / **[OFF]** / **[MEMORY]**

The default [Face Recog.] setting is [OFF].

When a face is registered, the setting will be [ON] automatically.

■ How the Face Recognition function works

During recording

- The camera recognizes a registered face and adjusts focus and exposure to match this face.
- When registered faces that have set names are recognized, the names are displayed (max. 3 people).

During playback

- The name and age are displayed (if this information is registered).
- The names that have been set for the recognized faces are displayed (max. 3 people).
- Only pictures of the selected registered people are played back in ([Category Play]).

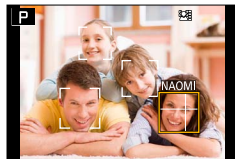

- **[Face Recog.] functions only when the Autofocus mode is set to [AF].**
- Only the first picture of an exposure series will contain Face Recognition information.
- The name of the person recognized in the first picture is displayed in the case of group pictures.
- Face Recognition searches for faces similar to those registered, but there is no guarantee it will always recognize these faces. In some cases, the camera cannot recognize or incorrectly recognizes even registered faces depending on their expression or the environment.
- Even if Face Recognition information is registered, pictures recorded when the name is [OFF] are not categorized for Face Recognition in [Category Play].
- **Even if Face Recognition information is changed, Face Recognition information for previously recorded pictures is not changed.**
For example, if a name is changed, pictures recorded before the change are not categorized for Face Recognition in [Category Play].
- To change name information for pictures already recorded, perform a [REPLACE] (→219) in [Face Rec Edit].

Using the Face Recognition Function [Face Recog.]



- [Face Recog.] cannot be set in the following cases:
 - During panorama picture recording
 - When the picture effect (Filter) is set ([Miniature Effect])
 - During motion picture recording
 - When using [Time Lapse Shot]

Registering face pictures

Up to 6 people's faces can be registered along with such information as name and date of birth.

Recording tips when registering faces

- Make sure the subject's eyes are open and mouth closed; have the subject face the camera directly, and make sure the outline of the face, the eyes and eyebrows are not hidden by hair.
- Make sure there are no heavy shadows on the face. (During registration, the flash is not used.)

Good example for registering a face



If the camera seems to have difficulty recognizing faces when recording

- Register additional pictures of the same person's face, indoors and outdoors or with different expressions or angles.
- Register additional pictures at the place you are recording.
- If a registered person is no longer recognized, re-register that person.

1 Use ▲ ▼ to select [MEMORY], and then press [MENU/SET].

2 Use ▲ ▼ ◀ ▶ to select [New], and then press [MENU/SET].

- If 6 people are already registered, first delete a registered person. (→165)

3 Align the face with the guide and take the picture.

- A confirmation screen is displayed. If you select [Yes], the operation is executed.
- Faces of subjects other than people (e.g. pets) cannot be registered.
- When ▶ is pressed, an explanation is displayed.

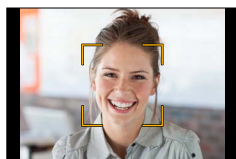
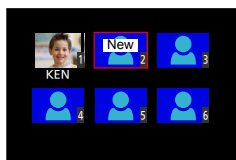

Using the Face Recognition Function [Face Recog.]

4 Use ▲ ▼ to select the item for editing, and then press [MENU/SET].

[Name]	① Use ▼ to select [SET], and press [MENU/SET]. ② Enter the name. (See "Entering Text": (→52))
[Age]	For setting the birth date. ① Use ▼ to select [SET], and then press [MENU/SET]. ② Use ◀▶ to select year, month and day, set with ▲▼, and press [MENU/SET].
[Add Images]	Up to 3 face pictures of the person can be registered. ① Use ◀▶ to select [Add], and then press [MENU/SET]. <ul style="list-style-type: none"> • If only one picture is registered, you can skip the cursor button operation. Just press [MENU/SET] to register an additional face picture. • When a registered face picture is selected with the cursor buttons, a screen to confirm deletion is displayed. Select [Yes] to delete the face picture. (If only one picture is registered, it cannot be deleted.) ② Record the picture. (step 3 (→164))

Editing or deleting information about registered persons

Information about registered faces can be edited or deleted.

1 Use ▼ to select [MEMORY], and then press [MENU/SET].**2 Use ▲ ▼ ◀▶ to select the picture of the person to be edited or deleted, and then press [MENU/SET].****3 Use ▲ ▼ to select the item, and then press [MENU/SET].**

[Info Edit]	For editing a name or other registered information. (Step 4 above)
[Priority]	For setting priority order for focus and exposure. ① Use ▲▼◀▶ to select the registration order, and then press [MENU/SET].
[Delete]	For deleting information and face pictures of registered persons. <ul style="list-style-type: none"> • A confirmation screen is displayed. If you select [Yes], the operation is executed.

Recording Profiles of Children and Pets on Pictures

Available in the following modes: **A P A S M**

By setting the name and birthday of your child or pet in advance, you can record their name and age in months and years on images.

■ Setting the name and age in months/years

① Set the menu item:

MENU →  **[Rec]** → **[Profile Setup]**

Settings: [] ([Baby1]) / [] ([Baby2]) / [] ([Pet]) / [OFF] / [SET]

② Use **▲▼** to select [SET], and then press [MENU/SET].

③ Use **▲▼** to select [Baby1], [Baby2] or [Pet], and then press [MENU/SET].

④ Use **▲▼** to select [Age] or [Name], and then press [MENU/SET].

⑤ Use **▲▼** to select [SET], and then press [MENU/SET].

Age: Set birthday with **▲▼◀▶**, and press [MENU/SET].

Name: (See "Entering Text": (→52))

⑥ Use **▼** to select [Exit], and then press [MENU/SET] to finish.

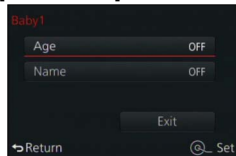

■ Canceling the display of the name and age in months/years

Select [OFF] in step ①.



- You cannot record the name or age in months/years in still pictures that are taken while recording motion pictures ( (motion picture priorities)) (→195).



Using Screens and Displays for Specific Recording Conditions

Marking potentially overexposed areas ([Zebra Pattern])

Available in the following modes: **A P A S M**

You can let areas that are brighter than a certain brightness level, i.e., which could result in overexposure, be identified using a zebra pattern. You can also set the brightness level to be represented by the zebra pattern.

MENU → **/C** [Custom] → **[Zebra Pattern]**

[ZEBRA1]	Displays an area brighter than a certain brightness level using a right-leaning zebra pattern.	
[ZEBRA2]	Displays an area brighter than a certain brightness level using a left-leaning zebra pattern.	
[OFF]	—	
[SET]	<p>For setting the brightness level for each zebra pattern. [Zebra 1] / [Zebra 2]</p> <p>1 Use ▲ ▼ to select the brightness level, and then press [MENU/SET].</p> <ul style="list-style-type: none"> The range of brightness levels you can select from is [50%] to [105%]. The [OFF] setting is available for [Zebra 2]. When [100%] or [105%] is selected, only the overexposed areas are displayed with the zebra pattern. When a lower value is set, less bright areas will be indicated by each zebra pattern. 	

Using Screens and Displays for Specific Recording Conditions

- If you wish to reduce the exposure, use [Manual Exposure] mode (→86) or Exposure Compensation (→135), using the histogram (→64) as a guideline.
- The displayed zebra pattern is not recorded.
- If you assign [Zebra Pattern] to [Fn Button Set] (→37) in the [Custom] menu, every time you press the assigned function button, the setting will switch in the following order: [Zebra 1] → [Zebra 2] → [Zebra OFF]. When [ZEBRA2] is set to [OFF], you can switch the setting quickly in the following order: [Zebra 1] → [Zebra OFF].

Displaying the recording screen in black and white ([Monochrome Live View])

Available in the following modes: **A P A S M**

You can display the recording screen in black and white. This function is useful as it can make focusing easier in Manual Focus mode.

MENU → **/C** [Custom] → [Monochrome Live View]

Settings: [ON] / [OFF]

- This does not affect recorded pictures.

Compensating Camera Shake



Available in the following modes: **A P A S M**

This function automatically detects and compensates camera shake.

1 Set the menu item:

MENU →  **[Rec]** → **[Stabilizer]**

2 Use ▲ ▼ to select the item, and then press **[MENU/SET]**.

 (Normal)	Compensates vertical and horizontal camera shake.
 (Panning)	Compensates vertical camera shake. This setting is ideal for panning (technique of recording a subject by matching the camera movement with the movement of a subject going in a specific direction).
[OFF]	[Stabilizer] does not work.







To prevent camera shake

If the camera shake warning is displayed, use [Stabilizer], a tripod, or [Self Timer]. In some cases, the blurring effect of camera shake can be reduced by using a higher setting for [Sensitivity] which in turn allows faster shutter speeds.

Camera shake alert display



Compensating Camera Shake

- When you use a tripod, we recommend setting [Stabilizer] to [OFF].
 - To perform panning by selecting [, we recommend using the viewfinder.
 - Cases where the stabilizer function may be ineffective:
 - When there is a lot of camera shake
 - When the zoom magnification is high (also in the Digital Zoom range)
 - When taking pictures while following a moving subject
 - When the shutter speed becomes slower while taking pictures indoors or in dark places
 - The panning effect by selecting [] is not fully achieved in the following cases:
 - Bright summer days or other bright locations
 - When the shutter speed is faster than 1/100s
 - When the motion of a subject is slow and the speed with which the camera is moved is too slow (a nice background blur is not achieved)
 - When the camera is not adequately tracking the motion of a subject
-  ● [Stabilizer] cannot be used by selecting [] (Normal) during panorama picture recording.

Using the Lens' Zoom Function

Available in the following modes: **A P A S M**

You can determine how much of a subject is to be captured / how large a subject is to be rendered by selecting the appropriate focal length, i.e. by zooming.

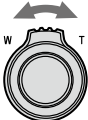
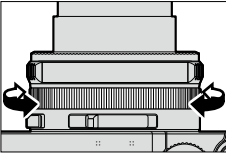
Zoom lever	Control ring
<p>① Move the zoom lever</p> 	<p>① Turn the control ring*</p>  <p>* You can change the focal length by assigning [Zoom] to the control ring. (→40)</p>
<p>T side: Telephoto, enlarges subjects W side: Wide-angle, captures a larger area</p>	<p>Clockwise: Telephoto, enlarges subjects Counterclockwise: Wide-angle, captures a larger area</p>

The illustration is an example of when using Optical Zoom, [i.Zoom], and [Digital Zoom] in [Program AE] Mode.

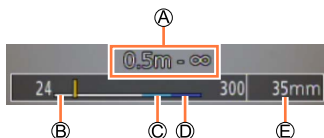

- Ⓐ Focusing range
- Ⓑ Optical Zoom range
- Ⓒ i.Zoom range
- Ⓓ Digital Zoom range
- Ⓔ Current zoom position (the indicated focal lengths are 35mm film camera equivalents)

- Do not touch the lens barrel during zooming.
- Focus (again) after changing the focal length (zooming).
- The zoom ratio and the zoom bar displayed on the screen are approximations.
- The camera may make a rattling noise and vibrate when the zoom lever is operated - this is not a malfunction.

Zoom types and use

The zoom ratio changes when the resolution is changed.



The magnification, or zoom ratios mentioned throughout these instructions and for the different settings below are based on that of the shortest focal length / maximum Wideangle setting, which is determined as 1x.

Optical Zoom

This function allows changing the focal length without reducing the picture quality.

Maximum magnification: 3.1x



The function is not available during panorama picture recording.

Extended optical zoom

This function works when resolutions with [EX] have been selected in [Picture Size] (→108). You can extended the focal length further than by zooming optically without reducing the picture quality.

Maximum magnification: 6.2x

(Including the optical zoom ratio. This maximum zoom ratio varies depending on the resolution.)



The function is not available in the following cases:

- When the picture effect (Filter) is set ([Toy Effect], [Toy Pop])
- During panorama picture recording
- When [Burst Rate] is set to [SH]
- When [HDR] is set to [ON]
- When [Multi Exp.] is set
- When [iHandheld Night Shot] is set to [ON]
- When [iHDR] is set to [ON]
- When the [Quality] setting is set to [RAW], [RAW] or [RAW]
- During motion picture recording

Using the Lens' Zoom Function

To increase the zoom ratio further, the following functions can be used in combination.

[i.Zoom]

Available in the following modes: **A P A S M**



You can use the camera's Intelligent Resolution technology to extend the focal length up to twice the original magnification ratio while minimizing the deterioration of picture quality.

MENU →  **[Rec]** → **[i.Zoom]** → **[ON] / [OFF]**

MENU →  **[Motion Picture]** → **[i.Zoom]** → **[ON] / [OFF]**



The function is not available in the following cases:

- When the picture effect (Filter) is set ([Impressive Art], [Toy Effect], [Toy Pop])
- During panorama picture recording
- When [Burst Rate] is set to [SH]
- When [HDR] is set to [ON]
- When [Multi Exp.] is set
- When [iHandheld Night Shot] is set to [ON]
- When [iHDR] is set to [ON]
- When the [Quality] setting is set to [RAW , [RAW , or [RAW]

Using the Lens' Zoom Function

[Digital Zoom]

Available in the following modes: **A P A S M**

You can use this function to achieve a magnification ratio four times larger than with Optical/Extended Optical Zoom, although the image quality deteriorates as you extend the focal length.

MENU →  **[Rec]** → **[Digital Zoom]** → **[ON] / [OFF]**

MENU →  **[Motion Picture]** → **[Digital Zoom]** → **[ON] / [OFF]**

- When [Digital Zoom] is used simultaneously with [i.Zoom], you can only increase the zoom ratio up to 2x.
- When using [Digital Zoom], we recommend using a tripod and the self-timer (→148).
- The AF area is largely displayed at the center in the Digital Zoom range.



The function is not available in the following cases:

- When the picture effect (Filter) is set ([Impressive Art], [Toy Effect], [Toy Pop], [Miniature Effect])
- During panorama picture recording
- When [Burst Rate] is set to [SH]
- When [HDR] is set to [ON]
- When [Multi Exp.] is set
- When the [Quality] setting is set to [RAW , [RAW ] or [RAW]

Using the Lens' Zoom Function

[Step Zoom]

Available in the following modes: **[A] [P] [A] [S] [M]**

You can set that zooming operates in steps, stopping at (equivalent) focal lengths familiar from 35mm film cameras.

1 Turn the control ring (→39)

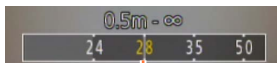

Current zoom position
(The displayed focal lengths are 35mm film camera equivalents)

■ Using the zoom lever for [Step Zoom]

You can use the zoom lever for [Step Zoom] by setting [Zoom lever] to [Step Zoom] in the [Custom] menu.

- The focal length values are for reference only.





The function is not available during motion picture recording.

Changing the zoom operation settings

MENU →  [Custom] → [Zoom lever]

MENU →  [Custom] → [Control Ring]

 Zoom	Changing the focal length (zooming) operates in the normal way.
 Step Zoom	With each zooming operation, the lens stops at the position for one of the preset focal lengths.

Retaining the zoom position when the camera is turned off

MENU →  [Custom] → [Zoom Resume] → [ON] / [OFF]

Using the Supplied Flash Unit

Available in the following modes: **A P A S M**

When the supplied flash unit is attached, you can use all flash modes ([MANUAL], etc.) in the camera's menu. (Note, however, that it cannot be used as a wirelessly controlled unit.) This section describes specifically how to take a picture using this unit.

- For details on how to take a picture using other flash units, refer to (→261).

Using flash, you can take pictures in dark places or achieve a more even illumination, e.g. in the case of backlit subjects.

Attaching the flash unit

The hot shoe cover is already inserted in the hot shoe at the time of purchase. Mount the flash unit in the hot shoe after removing the hot shoe cover.

Removing the hot shoe cover

- Make sure that the camera's [ON/OFF] switch is set to [OFF].

1 Remove the hot shoe cover by simultaneously pressing it in the direction indicated by arrow ① and pulling it in the direction indicated by arrow ②.

- Be sure to insert the hot shoe cover when the hot shoe is not in use.
- Store the hot shoe cover in a safe place after removing it so that you do not lose it.

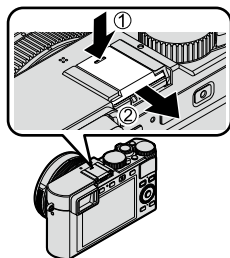

Attaching the flash unit

1 Turn off the flash unit.

2 Firmly insert the flash unit into the camera's hot shoe until it clicks into place.

- Set the camera's [ON/OFF] switch to [ON], and turn on the flash unit to take a picture.

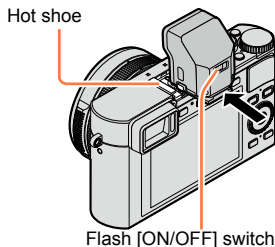

- Keep the hot shoe cover out of reach of children to prevent swallowing.
- Do not carry the camera by only holding the mounted flash unit.

Using the Supplied Flash Unit

■ Removing the flash unit

- ① Turn off the camera and the flash unit.
- ② Press and hold the lock release button and pull the flash unit in the direction indicated by the arrow to detach it.
 - When detaching the flash unit, do so slowly and carefully.
 - Insert the hot shoe cover into the hot shoe of the camera.
 - Store the detached flash unit in its soft pouch.

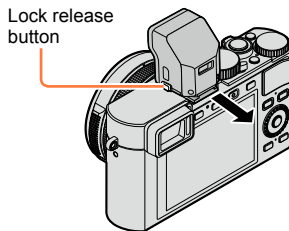

About [Forced Flash Off] ([⊕])

[⊕] (Forced Flash Off) will appear on the recording screen and the flash unit will not fire in the following cases.

- When the flash unit's [ON/OFF] switch is set to [OFF] even if it is attached
- When flash cannot be used, for example, when recording motion pictures

■ The available flash range when the [Sensitivity] setting is [AUTO]

The edges of the picture may become slightly dark if using flash at short distances with the lens set near its shortest focal length (close to max. W). This may be remedied by setting a slightly longer focal length.

Max. Wide	Max. Tele
approx. 0.6 - 14m (2-46')*	approx. 0.3 - 8.5m (1-27')*

*When [ISO Limit Set] is [OFF].



How to use flash effectively

Taking a picture using flash with the subject too close may cause overexposure. When you set [Highlight] in the [Custom] menu to [ON], the overexposed areas will flash black and white during [Auto Review] or playback. If that happens, we recommend taking the picture again, for example, after setting a lower flash output using [Flash Adjust.] (→184).

- Do not cover the light-emitting area of the flash unit (e.g. with a hand) or look at it from close range.
Do not use flash at close distances to other subjects (heat/light may damage subject).
- Flash charging may take longer if the battery is low or when using flash repeatedly. When the flash unit is being charged, the respective icon flashes red, and you cannot take a picture even when you fully press the shutter button.
- The flash is fixed to [⊘] (Forced Flash Off) in following cases:
 - During motion picture recording
 - When the picture effect (Filter) is set
 - During panorama picture recording
 - When using the electronic shutter
 - When [HDR] is set to [ON]
 - When [Silent Mode] is set to [ON]

Changing the flash control mode

Available in the following modes: **A P A S M**

You can select whether flash output is controlled automatically or manually.

1 Set the menu item:

MENU →  **[Rec]** → **[Flash]** → **[Firing Mode]**

2 Use ▲ ▼ to select the item, and then press [MENU/SET].

[TTL]	The camera automatically controls the flash output.
[MANUAL]	You can set the flash output manually. Using [TTL] allows you to take a picture as intended, even for dark scenes where the flash output tends to be higher.

- When [MANUAL] is selected, flash output (e.g. [1/1]) is displayed with the flash icon on the screen.

■ Setting the flash output (When [MANUAL] is selected)

① Set the menu item:

MENU →  **[Rec]** → **[Flash]** → **[Manual Flash Adjust.]**

② Press ◀ ▶ to select an item, and then [MENU/SET].

- You can set the flash output from [1/1] (flash firing full power) to [1/64] in 1/3 steps.

Changing the flash modes





Available in the following modes: **A P A S M**

This function allows you to select the flash mode to match the situation.

1 Set the menu item:

MENU →  **[Rec]** → **[Flash]** → **[Flash Mode]**

2 Press ▲ ▼ to select the item, and then [MENU/SET].

 : [Forced Flash On]	The flash is fired every time regardless of the recording conditions. <ul style="list-style-type: none"> • Use these modes when your subject is back-lit or under fluorescent light.
 : [Forced On/Red-Eye]*	
 : [Slow Sync.]	When taking pictures of dark subjects, this feature will use slower shutter speeds when the flash is fired, so dark backgrounds will appear brighter. <ul style="list-style-type: none"> • Use these modes when you take pictures of people in front of a dark background. • Using a slower speed can cause motion blur. Using a tripod can counteract this
 : [Slow Sync./Red-Eye]*	
 : [Forced Flash Off]	The flash is never fired, regardless of the lighting conditions. <ul style="list-style-type: none"> • Ideal for taking pictures where the use of flash is prohibited.



* This is available only when [Firing Mode] is set to [TTL] (→180).

Two flashes are fired. Both the subject and the camera should not move until after the second flash. The interval between the flashes varies according to the brightness of the subject.

- The red-eye reduction effect varies depending on the subject and is affected by factors such as the distance from the subject and whether the subject is looking at the camera during the first flash. In some cases, the red-eye reduction effect may be negligible.

Reducing red-eye

Available in the following modes: **A P A S M**

This function automatically detects red-eye and corrects the still picture data when recording with flash red-eye reduction (, ).

MENU →  **[Rec]** → **[Red-Eye Removal]**

Settings: **[ON]** / **[OFF]**

- When this function is set to [ON], the flash icon changes to /.



- Depending on the circumstances, it may not be possible to correct red-eye.

Using the Supplied Flash Unit

■ Shutter speed range according to the flash mode

Flash mode	Shutter speeds	Flash mode	Shutter speeds
	1/60*1 - 1/4000s		1 - 1/16000s
			120*2 - 1/16000s

*1 The shutter speed is set to 60 seconds in [Shutter-Priority] Mode and to T (time) in [Manual Exposure] Mode.

*2 The shutter speed is set to T (time) in [Manual Exposure] Mode.

- In [Snapshot Mode], the shutter speed changes depending on the scene mode being used.

■ Flash settings according to the exposure control mode (When the supplied flash unit is attached) (○: Available, –: Not available)

Recording Mode					
A [Snapshot Mode]	–*	–*	–*	–*	○
P [Program AE] Mode	○	○	○	○	○
A [Aperture-Priority] Mode	○	○	○	○	○
S [Shutter-Priority] Mode	○	○	–	–	○
M [Manual Exposure] Mode	○	○	–	–	○

*You cannot perform flash settings using the [Rec] menu. Set to [A], [A], [S] or [S] depending on the subject and brightness.

- Flash settings may be changed when changing the exposure control mode.
- Flash settings will be retained even if the camera is turned off.

Setting 2nd curtain sync



Available in the following modes: **A P A S M**



2nd curtain sync fires the flash at the end of the exposure as opposed to the normal firing time (at the beginning of the exposure). This can be utilized to create a certain effect (see below).

1 Set the menu item:

MENU →  **[Rec]** → **[Flash]** → **[Flash Synchro]**

2 Press ▲ ▼ to select the setting item, and then **[MENU/SET]**.

[1ST]	1st curtain sync is the normal method when using the flash.	
[2ND]	The light source appears behind the subject, making the picture appear more logical.	

- Normally, set to [1ST].
- If you set to [2ND], [2nd] will be displayed in the flash icon on the screen.
- The [Flash Synchro] setting is applied even when an external flash unit other than the supplied one is used. (→261)
- When a fast shutter speed is set, the [2ND] effect may not be very evident.
- When [2ND] is set, you cannot set the flash modes [] or [].

Flash exposure compensation

Available in the following modes: **A P A S M**

You can adjust the flash exposure to compensate for pictures in which the parts mainly illuminated by the flash would otherwise appear too dark or bright.

1 Set the menu item:

MENU →  **[Rec]** → **[Flash]** → **[Flash Adjust.]**

2 Press ◀▶ to set the flash output, and then **[MENU/SET]**.

Settings: -3 EV to +3 EV (unit: 1/3 EV)

When you do not want to adjust the flash exposure, select [±0 EV].

- When the flash exposure is compensated, [+] or [-] is displayed on the flash icon.
- The [Flash Adjust.] setting functions even when a flash unit other than the supplied one is used. (→261)

Synchronizing the flash output to an exposure compensation setting for the ambient light

Available in the following modes: **A P A S M**

When [Auto Exposure Comp.] is set to [ON], the flash output level will automatically be controlled to match the exposure compensation set for the exposure of the ambient light.

MENU →  **[Rec]** → **[Flash]** → **[Auto Exposure Comp.]**

Settings: **[ON]** / **[OFF]**

- About Exposure Compensation (→135)
- The [Auto Exposure Comp.] setting functions even when a flash unit other than the supplied one is used. (→261)

Recording Motion Pictures

This camera records motion pictures in the MP4 format. You can also record 4K motion pictures. (→191)

Audio is recorded in stereo.

Setting the resolution and the frame rate

Available in the following modes: **A P A S M**

1 Set the menu item:

MENU →  **[Motion Picture]** → **[Rec Quality]**

2 Use ▲ ▼ to select the item, and press **[MENU/SET]**.

Item	Resolution	Recording frame rate	Bit rate
[4K/100M/30p] *1 [4K/100M/25p] *2	3840×2160	30p*1/25p*2	approx. 100Mbps
[4K/100M/24p]	3840×2160	24p	approx. 100Mbps
[FHD/28M/60p] *1 [FHD/28M/50p] *2	1920×1080	60p*1/50p*2	approx. 28Mbps
[FHD/20M/30p] *1 [FHD/20M/25p] *2	1920×1080	30p*1/25p*2	approx. 20Mbps
[HD/10M/30p] *1 [HD/10M/25p] *2	1280×720	30p*1/25p*2	approx. 10Mbps
[VGA/4M/30p] *1 [VGA/4M/25p] *2	640×480	30p*1/25p*2	approx. 4Mbps

*1 With camera models 18 471 / 18 472

*2 With camera models 18 470 / 18 473

• What is bit rate

This is the volume of data for a defined period of time. The quality is higher when the number gets larger. This camera uses the "VBR" recording method. "VBR" is an abbreviation of "Variable Bit Rate", which means that it is changed automatically depending on the subject to record. Therefore, the recording time is shortened when a subject with fast movement is recorded.

■ About the compatibility of the recorded motion pictures

Motion pictures recorded in the MP4 format may be played back with poor picture or sound quality or playback may not be possible even when played back with equipment compatible with the format. Also, the recording information may not be displayed properly. In this case, use the camera.

- With camera models 18 471 / 18 472:

For details on motion pictures recorded with [4K/100M/30p] or [4K/100M/24p], refer to “Enjoying 4K motion pictures” (→248).

- With camera models 18 470 / 18 473:

For details on motion pictures recorded with [4K/100M/25p] or [4K/100M/24p], refer to “Enjoying 4K motion pictures” (→248).

How to focus when recording a motion picture ([Continuous AF])

Available in the following modes: **A P A S M**

The focusing procedure varies depending on the focus mode (→114) and the setting of [Continuous AF] in the [Motion Picture] menu.

[Focus]	[Continuous AF]	Setting
[AFS]/[AFF]/ [AFC]	[ON]	The camera automatically keeps focusing on subjects during recording. (→114)
	[OFF]	The camera maintains the focus position from the start of recording.
[MF]	[ON] / [OFF]	You can focus manually. (→128)

- When the focus mode is set to [AFS], [AFF], or [AFC], the camera will refocus if the shutter button is pressed halfway while recording motion pictures.
- The autofocus function is activated while you are recording motion pictures, the focusing operation sound may be recorded under some conditions. If you want to avoid this sound, we recommend taking pictures after setting [Continuous AF] to [OFF] in the [Motion Picture] menu.
- When changing the focal length (zooming) during motion picture recording, refocusing may take some time.

Recording motion pictures

Available in the following modes: **A P A S M**

You can record motion pictures by manually setting the aperture value and shutter speed. (→80)

In [Snapshot Mode], the camera automatically sets the aperture value and shutter speed and identifies the optimal scene to record motion pictures. (→76)

1 Press the motion picture button to start recording.

- Immediately release it after pressing it.
- While recording motion pictures, the recording status indicator (red) will flash.
- If you do not perform any operation for approximately 1 minute or longer, some of the information on the screen is turned off. To display the information again, press [DISP]. This takes place to prevent screen burn-in. This is not a malfunction.
- Do not cover the microphones when recording motion pictures.
- You can also change the focal length (zoom) while recording motion pictures.
 - The operating sounds of the zoom lever or control ring may be recorded in some cases.
- Still pictures can be taken during motion picture recording. (→195)

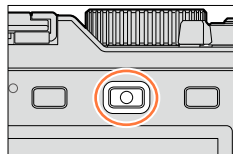

Recording state indicator



Elapsed recording time

Remaining recording time (approx.)

2 Press the motion picture button again to end recording.



About the aperture value and the shutter speed to be used for recording motion pictures

● About the aperture value

- Set the aperture value to a higher number when you want a larger in-focus area (in front of and behind the main subject), or to a lower number for the opposite.

● About the shutter speed

- Set a faster shutter speed if you want to take a sharp picture of a subject moving fast, or a slower shutter speed if you want to create e.g. subject blur to emphasize a movement.
- When you set a faster shutter speed, noise may increase due to the higher sensitivity automatically set by the camera.
- When you record a subject under fluorescent or LED lighting fixtures, etc., the colors and the screen brightness may change or horizontal striping may appear on the screen. If this happens, we recommend manually setting the shutter speed to 1/60s or 1/100s.



About the operation sound when recording ends

Since motion pictures are recorded until the motion picture button is pressed to stop recording, the operating sound level in the picture may be higher. To avoid this sound, we recommend trying the following method.



- Cut off the end of a motion picture using [Video Divide] (→211) in the [Playback] menu. In some cases, motion pictures cannot be divided at a position close to the end. To avoid this problem, continue recording for an extra 3 seconds.

Enabling/disabling the motion picture button

MENU →  [Custom] → [Video Button] → [ON] / [OFF]



- This function prevents accidental operation of the button.

Switching the angle of view setting used for recording still pictures and motion pictures

MENU →  [Custom] → [Rec Area] →  (Picture) /  (Motion picture)

- If the aspect ratio is different for still pictures and motion pictures, the angle of view will change when starting to record a motion picture.
When you set [Rec Area] to , the angle of view setting used for recording motion pictures is displayed.
- [Rec Area] should be regarded as a guideline.

Recording Motion Pictures

- If the surrounding temperature is high, or a motion picture is recorded continuously, [] is displayed and recording may be stopped halfway through to protect the camera.
- If Extended Optical Zoom is used before pressing the motion picture button, these settings will be cleared, and the angle of view will change significantly.
- Note that if you perform operations such as changing the focal length (zooming), using buttons or dials while recording a motion picture, operation noise may be recorded.
- The zoom speed will be slower than normal during motion picture recording.
- The available recording time displayed on the screen may not decrease regularly.
- Depending on the type of the card, the card access indication may appear for a while after recording motion pictures. This is not a malfunction.
- If you stop recording motion pictures too soon after you have set picture effect (Filter) of [Miniature Effect], the camera may continue recording for a certain time. Hold the camera steady until the camera stops recording.
- [ISO Limit Set] is disabled when you record motion pictures.
- Even if you set [Stabilizer] to [] (Panning) when you record motion pictures, it is fixed to [] (Normal).
- It is recommended to use a fully charged battery when recording motion pictures.



- Motion pictures cannot be recorded in the following cases:
 - During panorama picture recording
 - When the picture effect (Filter) is set ([Rough Monochrome], [Silky Monochrome], [Miniature Effect]*, [Soft Focus], [Star Filter], [Sunshine])
 - * Only when recording motion pictures with [Rec Quality] of [4K]
 - When using [Time Lapse Shot]
 - When using [Stop Motion Animation]

Recording motion pictures in 4K

Recording mode: **A P A S M**

You can create extremely high-detail motion pictures by setting [Rec Quality] to [4K].

- To record 4K motion pictures, use a UHS Speed Class 3 card. (→25)
- When you record 4K motion pictures, the angle of view will be small than with motion pictures of other resolutions.

■ To record 4K motion pictures

- ① Select the recording mode. (→59)
- ② Set [Rec Quality] in the [Motion Picture] menu to [4K/100M/30p]*1/[4K/100M/25p]*2 or [4K/100M/24p]. (→185)
- ③ Press the motion picture button to start recording.
- ④ Press the motion picture button again to end recording.

*1 With camera models 18 471 / 18 472

*2 With camera models 18 470 / 18 473

Creating a high-resolution still picture from a 4K motion picture [4K PHOTO]

You can create a high-resolution, approx. 8 megapixel still picture from a 4K motion picture.

This function is not available in [Snapshot Mode].

Recording 4K motion pictures

- To record 4K motion pictures, use a UHS Speed Class 3 card. (→25)

1 Set the menu item:

MENU →  **[Motion Picture]** → **[4K PHOTO]**



2 Press **▲▼** to select [ON], and then [MENU/SET].

A confirmation screen is displayed. If you select [Yes], the operation is executed.

- The appropriate motion picture mode for capturing a still picture from a 4K motion picture is selected and the motion picture can be recorded using still picture quality.
- Since the camera puts higher priority on the focus of a still picture captured from a 4K motion picture, focusing movement during motion picture recording may be noticeable.

The camera will automatically perform the following setting items.

Menu	Item
[Rec Quality]	[4K/100M/30p]*1/[4K/100M/25p]*2

*1 With camera models 18 471 / 18 472

*2 With camera models 18 470 / 18 473



3 Press **[/SET]** to display the recording screen.

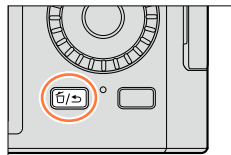

4 Turn the aperture ring and the shutter speed dial to set the recording mode.

- We recommend setting [Shutter-Priority] mode and setting the shutter speed to 1/1000s or faster to minimize subject blur. To record a subject that is moving quickly, set the shutter speed to 1/2000s or faster.

5 Set the aspect ratio for a motion picture with the respective switch.

- The aspect ratio of a still picture captured from a 4K motion picture is the same as the aspect ratio of the motion picture.

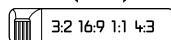
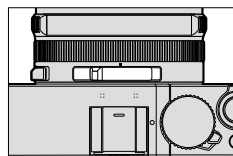
**6 Press the motion picture button to start recording.**

- When you record 4K motion pictures, the angle of view will be smaller than motion pictures of other resolutions.

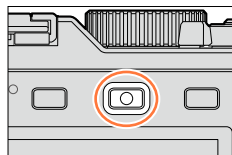
**Setting a marker**

- When you press [Fn2] while recording, you can add a marker to the motion picture.
- When you create still pictures from a motion picture, you can quickly move to the accordingly marked frame you want to capture as a still picture.
- You can add up to 40 markers in a single motion picture.

7 Press the motion picture button again to end recording.

- Motion picture recording can also be started or finished by pressing the shutter button.

Creating still pictures from a motion picture

1 Display the frame that you want to capture as a still picture by pressing **▲** to pause the motion picture being played back.

- You can press ◀▶ to perform single-frame forward/rewind operations.
- When you press [Fn2], and then ◀▶, you can quickly move to the marker position you set while recording the motion picture. (You can perform the same operation even during motion picture playback.)
If you press [Fn2] again, you can perform single-frame forward/rewind operations by pressing ◀▶.



2 Press [MENU/SET].

- A confirmation screen is displayed. Select [Yes], and then press [MENU/SET].
 - [Still] is displayed for a captured still picture.
- If you want to capture a still picture from a motion picture while the camera is connected to a TV with an HDMI micro cable, set [HDTV Link] of [TV Connection] in the [Setup] menu to [OFF].

Taking Still Pictures While a Motion Picture is Being Recorded

Available in the following modes: **A P A S M**

Still pictures can be recorded even while a motion picture is being recorded.
(Simultaneous recording)

1 Press the shutter button fully during the motion picture recording.



- When you take a still picture, the simultaneous still/motion picture recording icon is displayed.



Setting the motion picture or still picture priority mode

Available in the following modes: **A P A S M**

You can use [Picture Mode] in the [Motion Picture] menu to set the recording method of a still picture to be taken while you record a motion picture.

 <p>(motion picture priorities)</p>	<ul style="list-style-type: none"> • Takes a still picture using [Picture Size] [S] (2M). The picture quality may be different to [S] (2M) of standard pictures. • Only pictures in JPEG file format are recorded when [Quality] is set to [RAW], [RAW], or [RAW]. ([Quality] is used with the [RAW] setting when [RAW] is set.) • You can take up to 30 still pictures while you are recording a motion picture. • When the picture effect (Filter) is set to [Miniature Effect], a still picture may be taken with a slight delay from the time you fully press the shutter button.
 <p>(Still picture priorities)</p>	<ul style="list-style-type: none"> • A still picture is taken with [Picture Size] and [Quality] that you have set. • While a still picture is being taken, the screen turns black. During this period, the still picture is taken in the motion picture and the audio is muted. • You can take up to 4 still pictures while you are recording a motion picture.

- The aspect ratio of still pictures captured this way is fixed to [16:9].



- Still pictures cannot be recorded when [Rec Quality] is set to [4K/100M/30p]*1/[4K/100M/25p]*2, [4K/100M/24p], or [VGA/4M/30p]*1/[VGA/4M/25p]*2.

*1 With camera models 18 471 / 18 472

*2 With camera models 18 470 / 18 473

Using the [Motion Picture] Menu

For the setting procedures in the [Motion Picture] menu, refer to (→31).

- The [Photo Style], [AFS/AFF/AFC], [Metering Mode], [Highlight Shadow], [i.Dynamic], [i.Resolution], [i.Zoom], and [Digital Zoom] menu items are common for both [Rec] and [Motion Picture] menus.
If a setting in one menu is changed, the setting with the same name in other menu will also be changed automatically.
- The [Motion Picture] menu will not be displayed in the following cases:
 - During panorama picture recording

[4K PHOTO]

- For details (→192).

[Rec Quality]

- For details (→185).

[Picture Mode]

- For details (→195).

[Continuous AF]

- For details (→186).

Using the [Motion Picture] Menu

For the setting procedures in the [Motion Picture] menu, refer to (→31).

[Mic Level Disp.]

Available in the following modes: **A P A S M**

You can set whether or not to display the microphone level on the recording screen.

Settings: **[ON] / [OFF]**



The function is not available when the picture effect (Filter) is set ([Miniature Effect]).

[Mic Level Adj.]

Available in the following modes: **A P A S M**

You can adjust the audio input level in 4 steps.



The function is not available when the picture effect (Filter) is set ([Miniature Effect]).

[Wind Cut]

Available in the following modes: **A P A S M**

If you hear wind noise during an audio recording, you can use [Wind Cut] to effectively reduce it.

Settings: **[AUTO] / [HIGH] / [STANDARD] / [LOW] / [OFF]**

- When [Wind Cut] is set, the sound quality may differ from that of normal recordings.



The function is not available when the picture effect (Filter) is set ([Miniature Effect]).

Viewing Group Pictures

You can consecutively play back multiple pictures in a group or play back group pictures one by one.

- [▲📷]: Group pictures recorded consecutively by setting [Burst Rate] to [SH] (→142)
- [▲🕒]: Group pictures recorded using [Time Lapse Shot] (→153)
- [▲🎞️]: Group pictures recorded using [Stop Motion Animation] (→156)



- You can delete or edit pictures in groups. (For example, if you delete one of the pictures in a group, all pictures in that group will be deleted.)

Playing back group pictures consecutively

1 Select a picture with the group picture icon ([▲📷], [▲🕒], or [▲🎞️]), and then press ▲.

- When you play back group pictures one by one, the option settings are displayed.
 - [From the first picture]: Play back the group pictures consecutively from the first picture in a group.
 - [From the current picture]: Play back the group pictures consecutively from the picture currently played back.

■ Operations during continuous playback

▲	Continuous playback / Pause	▼	Stop
◀	Fast rewind playback	▶	Fast forward playback
	Returning to the previous picture (while paused)		Scrolling to the next picture (while paused)

Playing back group pictures one by one

1 Select a picture with the group picture icon ([▲📁], [▲🖼️], or [▲📷]), and then press ▼.

2 Use ◀▶ to scroll through the pictures.

- When you press ▼ again, the normal playback screen reappears.
- You can use the same operations for pictures stored in a group as in normal still picture playback. (Multi Playback, Playback Zoom, deletion of pictures, etc.)



- Pictures will not be grouped if they are recorded without setting [Clock Set].
- Picture series recorded on another device may not be recognized as group pictures.

Capturing Still Pictures From Motion Pictures

You can save a scene from a motion picture as a still picture.

- For capturing a still picture from a 4K motion picture, refer to (→192).

1 Display the picture that you want to capture as a still picture by pressing ▲ (pauses the motion picture being played back).

- When you press ◀▶ while paused, you can perform fast forward/rewind operations.



2 Press [MENU/SET].

- A confirmation screen is displayed. Select [Yes], and then press [MENU/SET].
- The still picture is saved with the aspect ratio [16:9] and the [Quality] [●●●]. The resolution varies depending on the motion picture being played back.
 - For motion pictures recorded in [Rec Quality] with [4K]: [M] (8M)
 - For motion pictures recorded in [Rec Quality] with [FHD], [HD]: [S] (2M)

- The picture quality becomes slightly lower depending on the [Rec Quality] setting of the original motion picture.
- When a still picture captured from a motion picture is played back, [●●●] is displayed.
- If you want to capture a still picture from a motion picture while the camera is connected to a TV with an HDMI micro cable, set [HDTV Link] of [TV Connection] in the [Setup] menu to [OFF].



- You cannot capture a still picture from motion pictures recorded using the [VGA/4M/30p]*1/[VGA/4M/25p]*2 setting.

*1 With camera models 18 471 / 18 472

*2 With camera models 18 470 / 18 473

Using the [Playback] Menu

You can specify picture protection, resizing, print settings, and other settings for pictures you have taken.

- For the setting procedures of the menu. (→31)

[Slide Show]

Automatically play pictures in order. Recommended when viewing on a TV.

1 Set the menu item:

[MENU] → [▶] [Playback] → [Slide Show]

2 Use ▲▼ to select the item, and then press [MENU/SET].

- When you select [Category Selection], use ▲▼◀▶ to select category, and then press [MENU/SET]. For details about category, refer to (→203).

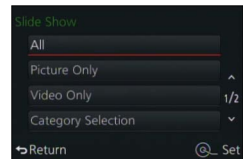

3 Use ▲ to select [Start], and then press [MENU/SET].

■ Operations during Slide Show



▲	Pause/Play	▼	Stop
◀	Previous	▶	Next
Control dial (counterclockwise)	Volume down	Control dial (clockwise)	Volume up

Using the [Playback] Menu

■ To change settings such as music or display time

Select [Effect] or [Setup], and then press [MENU/SET].

[Effect]		[AUTO] / [NATURAL] / [SLOW] / [SWING] / [URBAN] / [OFF]
[Setup]	[Duration]	[1SEC] / [2SEC] / [3SEC] / [5SEC]
	[Repeat]	[ON] / [OFF]
	[Sound]	[OFF]: Music and audio will not play back. [AUTO]: With still pictures, music will play back, and with motion pictures, audio will play back. [Music]: Music effects will play back. [Audio]: Audio is played back from motion pictures.

- When [URBAN] is selected, the picture may appear in black and white as a screen effect.
- [AUTO] can be used only when [Category Selection] is selected. The pictures are played back with the recommended effects for each category.
- When you perform a Slide Show playback by setting [Video Only] or [Category Selection] to , , or , [Effect] is fixed to [OFF].
- When you perform a Slide Show playback for a group picture, and even if [Effect] is set, the effects are disabled.
- When panorama, motion, or group pictures are played back, the [Duration] setting is disabled.
- [Duration] can be set only when [Effect] is set to [OFF].
- Part of [Effect] cannot be used when displaying pictures on a TV using an HDMI micro cable or when displaying pictures recorded in portrait position.
- Music effects cannot be added.

Using the [Playback] Menu

[Playback Mode]

Recorded pictures can be played back in a variety of ways.

1 Set the menu item:

[MENU] → **[▶]** **[Playback]** → **[Playback Mode]**

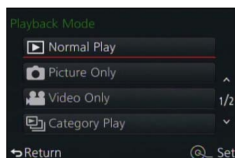
2 Use ▲▼ to select the item, and then press [MENU/SET].

When selecting [Category Play] in step 2 above

3 Use ▲▼◀▶ to select the category, and then press [MENU/SET].

- The available categories are as follows:

	[Face Recog.]*
	[i-Portrait], [i-Night Portrait], [i-Baby] in Automatic Scene Detection
	[i-Scenery], [i-Sunset] in Automatic Scene Detection
	[i-Night Portrait], [i-Night Scenery], [i-Handheld Night Shot] in Automatic Scene Detection
	[i-Food] in Automatic Scene Detection
	[Travel Date]
	A series of pictures recorded by setting [Burst Rate] to [SH]
	[Time Lapse Shot], [Time Lapse Video]
	[Stop Motion Animation], [Stop Motion Video]

* Use ▲▼◀▶ to select a person to be played back, and then press [MENU/SET]. Face Recognition is applied for all the pictures in the group.

- [Playback Mode] automatically changes to [Normal Play] when the camera is turned on, or when switching from the recording standby screen to the playback screen.
- The category for recording motion pictures is different from the category of still pictures used in some recording modes. For that reason, the pictures may not be played back.

[Location Logging]

After you send location information (latitude and longitude) obtained by your smartphone/tablet to the camera, you can write this information on pictures using the camera.

Preparation

- Send location information to the camera from your smartphone/tablet. (→234)
- You must install “Leica Image Shuttle” on your smartphone/tablet. (→225)

1 Set the menu item:

MENU →  **[Playback]** → **[Location Logging]** → **[Add Location Data]**

2 Use ▲▼ to select a period for writing location information, and then press [MENU/SET].

- A confirmation screen is displayed. If you select [Yes], the operation is executed.
- [GPS] is displayed for pictures that have location information written to it.

■ Abort writing location information

- Press [MENU/SET] while location information is being written.
 - [○] is displayed for the period of the abort operation.
If selected again while [○] is displayed, writing location information will resume where it left off.

■ Delete received location information

- Use ▲▼ to select [Delete Location Data], and then press [MENU/SET].
- Use ▲▼ to select a period for deleting location information, and then press [MENU/SET].
 - A confirmation screen is displayed. If you select [Yes], the operation is executed.

- Location information can be written only to pictures recorded with this camera.



The function is not available in the following cases:

- Location information may not be written if there is not enough free space on your card.
- The location information will not be written on pictures that were recorded after you sent the location information (→234).
- The location information cannot be written to pictures recorded without setting [Clock Set].



Writing the location information using a smartphone/tablet

When you use your smartphone/tablet as a remote controller for the camera, you can write the location information on pictures using the smartphone/tablet. (→235)

[RAW Processing]

You can use the camera to develop still pictures that were recorded in the RAW format. The processed pictures are saved in the JPEG format. You can process the pictures while confirming the effects on the screen.

1 Set the menu item:

[MENU] → **[▶]** **[Playback]** → **[RAW Processing]**

2 Press ◀▶ to select RAW file, and then [MENU/SET].

3 Press ▲▼ to select the item.



- The following items can be set. The settings used during recording are applied at the time of setting.

[White Balance]	You can select White Balance to make adjustments. When you select an item with [OK] , you can process the pictures using the same settings that were applied for recording.
[Exposure Comp.]	You can perform Exposure Compensation in the range from -1 EV to +1 EV.
[Photo Style]	You can select the [Photo Style] effects ([Standard], [Vivid], [Natural], [Monochrome], [Scenery], or [Portrait]).
[i.Dynamic]	You can select the [i.Dynamic] settings ([HIGH], [STANDARD], [LOW], or [OFF]).
[Contrast]	You can adjust the contrast.
[Highlight]	You can adjust the brightness of a bright area.
[Shadow]	You can adjust the brightness of a dark area.
[Saturation] / [Color Tone]	You can adjust the saturation. (You can adjust the coloring when [Monochrome] is selected for [Photo Style].)
[Filter Effect]	You can select a Filter effect. (Only when [Monochrome] is selected for [Photo Style])
[Noise Reduction]	You can set noise reduction.
[i.Resolution]	You can select the [i.Resolution] settings ([HIGH], [STANDARD], [LOW], [EXTENDED], or [OFF]).
[Sharpness]	You can adjust the impression of resolution.
[Setup]	You can perform the following settings. [Reinstate Adjustments]: You can restore the settings to the ones used during recording. [Color Space]: You can select [Color Space] from either [sRGB] or [Adobe RGB]. [Picture Size]: You can select the resolution ([L], [M], or [S]) of a JPEG file when saving pictures.

Using the [Playback] Menu

4 Press [MENU/SET] to set.

- The setting methods vary depending on the item. For details, refer to "Setting each item".

5 Press [MENU/SET].



- The screen in step 3 reappears. To set another item, repeat steps 3 to 5.

6 Press ▲ ▼ to select [Begin Processing], and then [MENU/SET].

- A confirmation screen is displayed. If you select [Yes], the operation is executed.

■ Setting each item

When you select an item, the setting screen appears.

 Control dial	Use to make adjustments
	Use to display the color temperature setting screen (→105) (Only when [White Balance] is set to [K])
	Use to display the White Balance fine adjustment screen (→105) (Only when [White Balance] is set)
[DISP]	Use to display the comparison screen
[MENU/SET]	Use to finalize a setting you just made and to return to the item selection screen

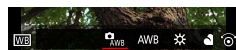
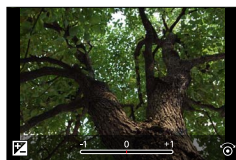

- If you select [Noise Reduction], [i.Resolution], or [Sharpness], the comparison screen is not displayed.
- Pictures can be enlarged by operating the zoom lever.

The following operating methods are available to make adjustments on the comparison screen.

 Control dial	Use to make adjustments
[DISP]	Use to return to the setting screen
[MENU/SET]	Use to finalize a setting you just made and to return to the item selection screen

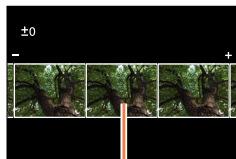

Current setting

When [Setup] is selected

When you select an item, the screen for selecting [Reinstate Adjustments], [Color Space], or [Picture Size] is displayed.

① Use ▲ ▼ to select the item, and then press [MENU/SET].

- When [Reinstate Adjustments] is selected, a confirmation screen is displayed. When you select [Yes], the item selection screen reappears.

② Use ▲ ▼ to select the setting, and then press [MENU/SET].

- The range that can be set using exposure compensation differs from the range used during recording.
- The [White Balance] setting of still pictures recorded using [Multi Exp.] is fixed to the setting used during recording.
- If [Red-Eye Removal] is activated during recording, you can use [RAW Processing] in the [Playback] menu to save JPEG file pictures in which red-eye was detected and corrected.
- You cannot perform RAW processing using multiple still pictures simultaneously.



- When an AV or an HDMI micro cable is connected, [RAW Processing] is disabled.
- You can perform RAW processing on pictures recorded using this camera only. [RAW Processing] cannot be used for pictures recorded on other devices or for pictures recorded in formats other than the RAW format.

[Title Edit]

You can enter characters (comments) on a recorded picture.

1 Set the menu item:

[MENU] → **[Playback]** → **[Title Edit]** → **[Single] or [Multi]**

2 Select a still picture.

[Single]

① Use ◀▶ to select a still picture, and then press [MENU/SET].



[Multi] (up to 100 pictures)

① Use ▲▼◀▶ to select a still picture, and then press [MENU/SET].

- To cancel → Press [MENU/SET] again.
- To execute → Use ◀ to select [OK], and then press [MENU/SET].

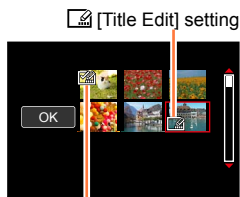

[Title Edit] already set

3 Enter the characters. (Entering text (→52))

- To delete a title, delete all the characters in the character input screen.

- To print the entered text, use [Text Stamp].



The function is not available in the following cases:

- Motion pictures
- Still pictures recorded with the [Quality] setting [RAW:■■■], [RAW:■■.] or [RAW]

[Text Stamp]

You can stamp the recording date and time, names, travel destination, travel dates, etc. on the recorded still pictures.

1 Set the menu item:

[MENU] → **[Playback]** → **[Text Stamp]** → **[Single]** or **[Multi]**

2 Select a still picture.

[Single]

① Use **◀▶** to select a still picture, and then press **[MENU/SET]**.



[Multi] (up to 100 pictures)

① Use **▲▼◀▶** to select a still picture, and then press **[MENU/SET]**.

[Text Stamp] setting
 [Text Stamp] already set

- To cancel → Press **[MENU/SET]** again.
- To execute → Use **◀** to select **[OK]**, and then press **[MENU/SET]**.

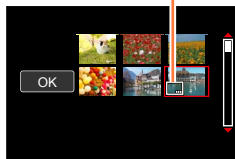

3 Use **▲▼** to select **[Set]**, and then press **[MENU/SET]**.

4 Use **▲▼** to select the item, and then press **[MENU/SET]**. (→210)

5 Use **▲▼** to select the setting, and then press **[MENU/SET]**. (→210)



6 Press **[↵/⏪]**.

7 Use **▲▼** to select **[OK]**, and then press **[MENU/SET]**.

- A confirmation screen is displayed. If you select **[Yes]**, the operation is executed.

Using the [Playback] Menu

■ Items that can be stamped

[Shooting Date]	[W/O TIME]: Stamps the recording date [WITH TIME]: Stamps the recording date and time
[Name]	 : Stamps the name registered in Face Recognition  : Stamps the name registered in [Profile Setup]
[Location]	Stamps the location registered in [Setup] menu's [Travel Date]
[Travel Date]	Stamps the number of days that have elapsed since the travel date set in [Setup] menu's [Travel Date]
[Title]	Stamps the text registered in [Title Edit]

- Items set to [OFF] are not stamped.

- **Do not request date printing in a store or set date printing on a printer for still pictures with date stamps. (Date printing may be overlapped.)**
- Characters may be cut off on certain printers.
- If you stamp text on the pictures in a group, those pictures are saved as new pictures.
- Text is difficult to read when stamped on pictures with a resolution of 0.3M or less.



The function is not available in the following cases:

- Motion pictures
- Still pictures recorded with the [Quality] setting [RAW]
- Panorama pictures
- Still pictures in which other texts had already been stamped
- Still pictures taken without setting clock

[Video Divide]



A motion picture take can be split into 2 parts. This is convenient when you want to keep just the necessary scenes, or if you wish to delete unnecessary scenes to increase free space on your card, such as when traveling.

1 Set the menu item:

MENU →  **[Playback]** → **[Video Divide]**

2 Use to select a motion picture to split, and then press **[MENU/SET]**.

3 Press at where you want to split the motion picture to pause it.

- If you press   while paused, you can make finer adjustments to the splitting positions.
- If you press  again, the motion picture is played back from the last position prior to activating pause.

4 Press .

- A confirmation screen is displayed. Select **[Yes]**, and then press **[MENU/SET]**.
- **The original motion picture that was split is not retained.**
(There will only be the 2 new motion pictures that were created by the split.)



- During dividing, do not turn off the camera or remove the card or the battery. If you do so, the motion picture may be deleted.
- If you divide a motion picture recorded in the MP4 format when the picture display sequence is set to **[FILE NAME]**, the order of the pictures will change. It is recommended to set the display sequence to **[DATE/TIME]** or to display using **[Calendar]**.



- Motion pictures cannot be divided close to their beginning or end.
- Motion pictures with a short recording time cannot be divided.

[Time Lapse Video]

You can create a motion picture from the pictures in a group that was recorded using [Time Lapse Shot].

1 Set the menu item:

MENU →  **[Playback]** → **[Time Lapse Video]**

2 Use to select the [Time Lapse Shot] picture group, and then press **[MENU/SET]**.

3 Create a motion picture after selecting a production method.

- The process is the same as that used to create a motion picture after recording pictures using [Time Lapse Shot]. For details, refer to step **5** and the subsequent steps (→154). For details on the resulting motion picture, refer to (→155).

[Stop Motion Video]

You can create a motion picture from the pictures in a group that was recorded using [Stop Motion Animation].

1 Set the menu item:

MENU →  **[Playback]** → **[Stop Motion Video]**

2 Use to select a stop motion animation group, and then press **[MENU/SET]**.

3 Create a motion picture after selecting a production method.

- The process is the same as that used to create a motion picture after recording pictures using [Stop Motion Animation]. For details, refer to step **8** and the subsequent steps (→158). For details on the resulting motion picture, refer to (→159).

[Resize]

A still picture's resolution can be reduced to facilitate e-mail attachment and use in web pages, etc.

1 Set the menu item:

[MENU] → **[Playback]** → **[Resize]** → **[Single]** or **[Multi]**

2 Select the picture and the resolution.

[Single]

- ① Use **◀▶** to select a still picture, and then press **[MENU/SET]**.
- ② Use **▲▼** to select the resolution, and then press **[MENU/SET]**.
 - A confirmation screen is displayed. If you select **[Yes]**, the operation is executed.

[Multi] (up to 100 pictures)

- ① Use **▲▼** to select the resolution, and then press **[MENU/SET]**.
 - ② Use **▲▼◀▶** to select a still picture, and then press **[MENU/SET]**.
 - A confirmation screen is displayed. If you select **[Yes]**, the operation is executed.
- To cancel → Press **[MENU/SET]** again.
 - To execute → Use **◀** to select **[OK]**, and then press **[MENU/SET]**.

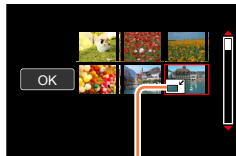

Resize setting

- The picture quality is reduced after resizing.



- Still pictures recorded at the lowest resolution level cannot be further reduced.
- The following types of pictures cannot be resized:
 - Motion pictures
 - Still pictures recorded with the **[Quality]** setting **[RAW]**
 - Panorama pictures
 - Group pictures
 - Still pictures in which texts had already been stamped

[Cropping]

This mode allows you to enlarge the decisive parts of still pictures (cropping), i.e. by "cutting off" unwanted areas.

1 Set the menu item:

[MENU] → **[▶]** **[Playback]** → **[Cropping]**

2 Use **◀▶** to select a still picture, and then press **[MENU/SET]**.

3 Select the area to crop, and then press **[MENU/SET]**.

- A confirmation screen is displayed. If you select [Yes], the operation is executed.

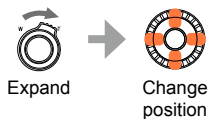

- Perform cropping for each picture in the group separately. (You cannot edit pictures in group units.)
- If you crop a picture in the group, it is saved as a new picture.
- Original Face Recognition information will not be copied when still pictures are cropped.
- The picture quality is reduced after cropping.



The function is not available in the following cases:

- Motion pictures
- Still pictures recorded with the [Quality] setting [RAW]
- Panorama pictures
- Still pictures in which texts had already been stamped

[Rotate] / [Rotate Disp.]

You can automatically display a still picture recorded in portrait orientation by taking the picture with the camera held vertically, or manually rotate the picture in 90-degree steps.

[Rotate] Rotating a picture manually

- You cannot select [Rotate] when [Rotate Disp.] is set to [OFF].

1 Set the menu item:

[MENU] → **[Playback]** → **[Rotate]**

2 Use ◀▶ to select picture, and then press [MENU/SET].

- You cannot rotate group pictures.

3 Use ▲▼ to select the rotation direction, and then press [MENU/SET].

[↻]: Rotates a picture 90 degrees clockwise.

[↶]: Rotates a picture 90 degrees counterclockwise.

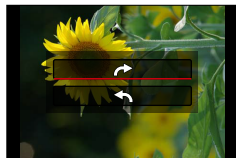

[Rotate Disp.] Rotating a displayed picture automatically

1 Set the menu item:

[MENU] → **[Playback]** → **[Rotate Disp.]** → **[ON]**

- When this function is set to [OFF], the picture is displayed without changing its orientation.



The function is not available in the following cases:

- When you play back pictures on a computer, they cannot be displayed in the rotated direction unless the OS or software is compatible with Exif. Exif is a file format for still pictures which allows recording information, etc. to be added. It was established by "JEITA (Japan Electronics and Information Technology Industries Association)".
- A picture may not be automatically rotated to display it with portrait orientation on the Multi Playback screen, which is displayed for settings such as [Delete Multi].

Using the [Playback] Menu

[Favorite]

By mark your favorite pictures with a star [★], you can play back your favorite pictures only, or you can delete all pictures except your favorites.

1 Set the menu item:

[MENU] → **[▶]** **[Playback]** → **[Favorite]** → **[Single]** or **[Multi]**

2 Select the picture.**[Single]**

- ① Use **◀▶** to select the picture, and then press **[MENU/SET]**.
- To cancel → Press **[MENU/SET]** again.



Favorite picture setting

[Multi] (up to 999 pictures)

- ① Use **▲▼◀▶** to select the pictures, and then press **[MENU/SET]**.
- To cancel → Press **[MENU/SET]** again.

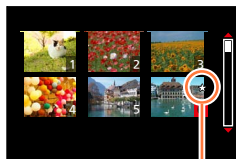

Favorite picture setting

■ To clear all

In step **1**, select **[Favorite]** → **[Cancel]** → **[Yes]**, and then press **[MENU/SET]**.

- When you set **[Favorite]** for a picture in a group, the number of pictures set is displayed with the **[Favorite]** icon of the first picture.
- Only when **[Playback Mode]** is set to **[Normal Play]**, you can select **[Cancel]**.



The function is not available in the case of still pictures recorded with the **[Quality]** setting **[RAW]**.

[Print Set]

Picture/picture no./date printing settings can be made for when printing with DPOF print-compatible shops or printers. (Ask at the shop to check for compatibility.)

1 Set the menu item:

[MENU] → **[Playback]** → **[Print Set]** → **[Single]** or **[Multi]**

2 Select a still picture.

[Single]

① Use **◀▶** to select a still picture, and then press **[MENU/SET]**.

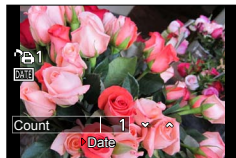

[Multi]

① Use **▲▼◀▶** to select the still pictures, and then press **[MENU/SET]**.

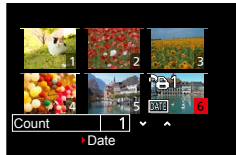

3 Use **▲▼** to set the number of still pictures, and then press **[MENU/SET]**.

(Repeat steps **2** and **3** when using **[Multi]** (up to 999 pictures))

- Date print setting/release → Press **▶**.

■ To clear all

In step **1**, select **[Print Set]** → **[Cancel]** → **[Yes]**, and then press **[MENU/SET]**.

- When you have performed **[Print Set]** for pictures in a group, printing settings are made for the total of number of pictures set in that group. If the total number of pictures is 1,000 or higher, [999+] is displayed.
- When you perform **[Print Set]** for a picture in a group, the number of pictures set and the total number of pictures are displayed with the Print Set icon of the first picture.
- Date print setting cannot be made for pictures with a **[Text Stamp]** applied.
- Depending on the type of printer, the printer settings may take priority over camera settings.
- Some DPOF information (print settings) set by other equipment cannot be used. In such cases, delete all of the DPOF information and then set it again with this camera.



The function is not available in the following cases:

- Motion pictures
- Still pictures recorded with the **[Quality]** setting **[RAW]**
- Files that are not compliant with the DCF standard.

[Protect]

Set protection to disable picture deletion. This prevents deletion of important pictures.

1 Set the menu item:

[MENU] → [▶] [Playback] → [Protect] → [Single] or [Multi]

2 Select picture.

[Single]

- ① Use ◀▶ to select the picture, and then press [MENU/SET].
- To cancel → Press [MENU/SET] again.



Picture protected

[Multi]

- ① Use ▲▼◀▶ to select the pictures, and then press [MENU/SET].
- To cancel → Press [MENU/SET] again.



Picture protected

■ To clear all

In step **1**, select [Protect] → [Cancel] → [Yes], and then press [MENU/SET].



When you set the write-protect slider on the card to the "LOCK" position, the picture is not erased.

- The picture is erased when formatting, even if it is protected.
- This setting may not be effective when using other devices.
- When you set [Protect] for a picture in a group, the number of pictures set is displayed with the [Protect] icon of the first picture.

[Face Rec Edit]

This function allows editing or deleting the recognition information for pictures with mistaken Face Recognition.

1 Set the menu item:

[MENU] → **[▶]** **[Playback]** → **[Face Rec Edit]** → **[REPLACE]** or **[DELETE]**

2 Use **◀▶** to select the picture, and then press **[MENU/SET]**.

3 Use **◀▶** to select a person, and then press **[MENU/SET]**.

- In case of **[DELETE]**, go to step 5.
- People whose Face Recognition information has not been registered cannot be selected.

4 Use **▲▼◀▶** to select the person to replace for another, and then press **[MENU/SET]**.

5 Use **◀▶** to select **[Yes]**, and then press **[MENU/SET]**.

- When Face Recognition information is deleted, it cannot be restored.
- Pictures for which all Face Recognition information has been deleted are not categorized in Face Recognition during **[Category Play]** or **[Category Selection]**.
- Edit the Face Recognition information in group units for a group picture. (You cannot edit the information for each picture in a group.)
- You can edit only the first picture in a group.

[Picture Sort]

You can set the display sequence used for playing back pictures on the camera.

1 Set the menu item:

MENU → **[Playback]** → **[Picture Sort]**

2 Use ▲ ▼ to select the item, and then press [MENU/SET].

[FILE NAME]	Displays pictures in the folder name or file name sequence. This display format allows you to find the storage location of a picture on a card more easily.
[DATE/TIME]	Displays pictures according to the date and time that the pictures were taken in chronological order. When the pictures are taken using several cameras and stored on the same card, this display format allows you find a specific picture more easily.

- Pictures may not be displayed according to the [DATE/TIME] sequence immediately after a card is inserted into this unit. In that case, wait a while, and the pictures will be displayed in the [DATE/TIME] sequence.

[Delete Confirmation]

You can set the Yes/No options that you want to select first on the confirmation screen when you delete a picture from either [Yes] or [No].

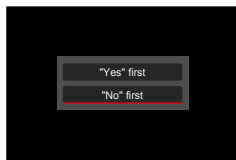

1 Set the menu item:

MENU → **[Playback]** → **[Delete Confirmation]**

2 Use ▲ ▼ to select the item, and then press [MENU/SET].

["Yes" first]	[Yes] is selected by default to quickly perform a deletion.
["No" first]	[No] is selected by default. This setting will prevent you from accidentally deleting pictures.

Wi-Fi® and NFC Functions

■ Use of the camera as a wireless LAN device

When using equipment or computer systems that require more reliable security than wireless LAN devices, ensure that the appropriate measures are taken for safety designs and defects for the systems used. Leica Camera AG will not take any responsibility for any damage that arises when using the camera for any purpose other than as a wireless LAN device.

■ Use of the Wi-Fi function of this camera is presumed to be in countries where this camera is sold

There is the risk that the camera violates the radio transmitter regulations if used in countries other than those where this camera is sold, and Leica Camera AG takes no responsibility for any violations.

■ There is the risk that data sent and received via radio transmission may be intercepted by a third party. We strongly recommend that you enable encryption in the settings of your wireless access point to ensure information security.

■ Do not use the camera in areas with magnetic fields, static electricity or interference, such as near microwave ovens. Transmissions may not reach the camera.

- Using the camera near devices such as microwave ovens or cordless telephones that use the 2.4 GHz radio transmission band may cause a decrease in performance in both devices.

■ Do not connect to wireless networks you are not authorized to use

When the camera utilizes its Wi-Fi function, wireless networks will be searched automatically. When this happens, wireless networks that you are not authorized to use (SSID*) may be displayed, however do not attempt to connect to these network as it may be considered as unauthorized access.

*SSID refers to the name that is used to identify a network over a wireless LAN connection. If the SSID matches for both devices, transmission is possible.

■ Before Use

- To use the Wi-Fi function on the camera, a wireless access point or a destination device equipped with the wireless LAN function is required.

■ The camera is compatible with NFC

Using the NFC (Near Field Communication) function, the camera and a smartphone/tablet can easily exchange the information needed to establish a Wi-Fi connection.

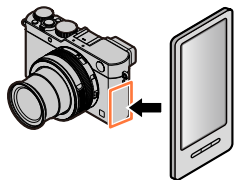

■ About the Wi-Fi connection lamp

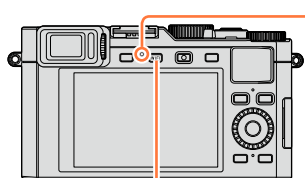

Wi-Fi connection lamp
 Lit blue: When the Wi-Fi function is ON
 Flashing blue: When sending data

[WIFI] button

■ About the [WIFI] button

The [WIFI]/[Fn2] button operates in two ways: Use it either as the [WIFI] or as a function button.

It is set to [WIFI] at the time of purchase.

For more details about function buttons (→37)

- Before a Wi-Fi connection is established, press [WIFI] to perform the following operations:
 (You can also display the same menu by selecting **MENU** → **X** [Setup] → [Wi-Fi] → [Wi-Fi Function].)

[New Connection]

[Select a destination from History] (→244)

[Select a destination from Favorite] (→244)
--

- Pressing [WIFI] during a Wi-Fi connection enables the following operation.

[Terminate the Connection]	Terminates the Wi-Fi connection.
[Change the Destination]	Terminates the Wi-Fi connection, and allows you to select a different one.
[Change Settings for Sending Images]	For details (→246).
[Register the Current Destination to Favorite]	Registering the current connection destination or the connection method, you can easily connect with the same connection method next time.
[Network Address]	Displays the MAC address and IP address of this unit. (→247)

- **Do not remove the memory card or battery or move to an area without any reception while sending images.**
- The camera cannot be used to connect to a public wireless LAN connection.
- Use a IEEE802.11b, IEEE802.11g or IEEE802.11n compatible device when using a wireless access point.
- We recommend that you use a fully charged battery when you send pictures.
- When the battery indicator is flashing red, the connection with other equipment may not start or the connection may be disrupted. (A message such as [Communication error] is displayed.)
- When sending images on a mobile network, high packet communication fees may be incurred depending on the details of your contract.
- Pictures may not be completely sent depending on radio transmission conditions. If the connection is terminated while sending pictures, pictures with missing sections may be sent.
- The monitor display may become distorted for an instant while connected to the service, however this will not affect the image being sent.

What You Can do With the Wi-Fi Function

Operating the camera by connecting it to a smartphone (→225)

Taking pictures via a smartphone (remote recording)

Playing back pictures in the camera on a smartphone/tablet

Saving pictures in the camera to the smartphone/tablet

Sending pictures in the camera to social networking services

Writing the location information on pictures in the camera

Connect easily, transfer pictures easily

You can easily use the Wi-Fi function by pressing and holding the [WIFI] button or using the NFC function.

Press and hold



Hold the device close to the camera

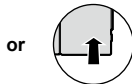

or

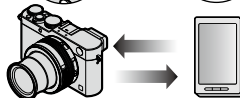

- Hereafter, these instructions uses the term “smartphone” for both smartphones and tablets unless it is necessary to distinguish between them.

Operating the Camera by Connecting it to a Smartphone

You can remotely operate the camera using a smartphone.

The "Leica Image Shuttle" (hereafter "Image Shuttle") must be installed on your smartphone.

Installing the smartphone/tablet app "Leica Image Shuttle"

"Leica Image Shuttle" is an application provided by Leica Camera AG that allows your smartphone to perform the following operations of a Wi-Fi-compatible Leica compact digital camera.

- Taking pictures via a smartphone (remote recording) (→231)
- Playing back pictures in the camera on a smartphone (→232)
- Saving pictures in the camera to the smartphone (→232)
- Easily transferring pictures in the camera (→233)
- Sending pictures in the camera to social networking services (→234)
- Adding location information to pictures in the camera from a smartphone (→234)

	For Android™ apps	For iOS apps
Supported OS	Android 2.3.3 or later*1	iOS 6.0 or later (iPhone 3GS is not supported.)
Installation procedure	<ol style="list-style-type: none"> ① Connect your Android device to a network ② Select "Google Play™ Store"*2 ③ Enter "Leica Image Shuttle" into the search box ④ Select "Leica Image Shuttle" and install it <ul style="list-style-type: none"> • The icon will be added to the menu.  <p>*2 Not available in China. To download in China, please visit the site below: www.leica-camera.com</p>	<ol style="list-style-type: none"> ① Connect the iOS device to the network ② Select "App StoreSM" ③ Enter "Leica Image Shuttle" into the search box ④ Select "Leica Image Shuttle" and install it <ul style="list-style-type: none"> • The icon will be added to the menu. 

*1 To connect the camera with [Wi-Fi Direct], Android OS 4.0 or above is required and the device must be compatible with Wi-Fi Direct™.

- **Use the latest version.**
- **Supported OS versions as of September 2014. Supported OS versions may be changed without prior notice.**
- **Some of the screens and information provided in this document may be different depending on the supported operating system and the "Image Shuttle" version.**
- **The service may not be able to be used properly depending on the type of smartphone being used.**
- **For details about the operating procedure, etc., refer to [Help] in the "Image Shuttle" menu.**
- When downloading the app on a mobile network, high packet communication fees may be incurred depending on the details of your contract.

Operating the Camera by Connecting it to a Smartphone

Connecting to a smartphone

You can easily establish a Wi-Fi connection on the camera by pressing and holding the [WIFI] button or using the NFC function.

Preparation

Install "Image Shuttle" in advance. (→225)

1 Press and hold the [WIFI] button.

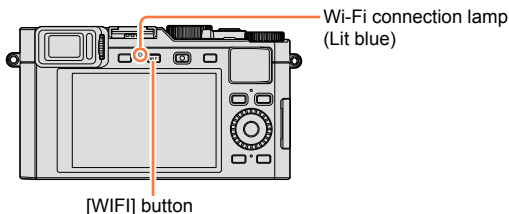

- The information (QR Code, SSID and Password) required for directly connecting your smartphone to the camera is displayed.
- After the second time, the screen for the previously used connection method will appear.
- The same screen can be displayed by selecting items from the menu as follows.

[WIFI] → **[New Connection]** →
[Remote Shooting & View]

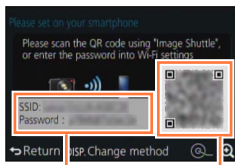

SSID and Password

QR Code

- When you press [MENU/SET] on the camera, the QR code is displayed in an enlarged size. If it is difficult to read the code, use the enlarge view. (If your smartphone cannot read the QR code, move the camera away from the smartphone or use a connection method other than the QR code.)
- To change the connection method, press [DISP] and select the connection method. (→229)

2 Operate the smartphone.

- When the connection is complete, live images being captured by the camera are displayed on the smartphone.
(It may take some time after the operation for the connection to be established.)
- The connection method differs depending on the smartphone used. (→227, 228)

Operating the Camera by Connecting it to a Smartphone

■ Using an iOS device

- When reading a QR Code to connect (Steps ① to ⑤ are not necessary when reconnecting.)

① Start “Image Shuttle”. (→225)

② Select [QR Code] → [OK].

③ Read the QR Code displayed on the camera with “Image Shuttle”.

(When you press [MENU/SET] on the camera, the QR code is displayed in an enlarged size.)

④ Install the “Image Shuttle” profile



Select [Install]*, then select [Install Now]* → [Done]*.

- The message is displayed in the Web browser.
- If a passcode is required to unlock the smartphone, you will have to input the passcode.

⑤ Press the home button to close the Web browser.

⑥ Select [Wi-Fi]* under [Settings]* on the smartphone.

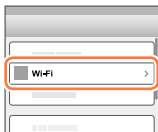

⑦ Turn on [Wi-Fi]* and select the SSID displayed on this unit.



⑧ Return to the home screen and start “Image Shuttle”. (→225)

*The display may differ depending on the system language setting.

Operating the Camera by Connecting it to a Smartphone

- When connecting with SSID and password
 - ① Select [Wi-Fi]* under [Settings]* on the smartphone.
 - ② Turn on [Wi-Fi]* and select the SSID displayed on this unit.
 - ③ Enter the password displayed on the camera (First time connecting only).
 - ④ Return to the home screen and start "Image Shuttle". (→225)

*The display may differ depending on the system language setting.

■ Using an Android device

- When reading a QR Code to connect
 - ① Start "Image Shuttle". (→225)
 - ② Select [QR Code].
 - ③ Read the QR Code displayed on the camera with "Image Shuttle".
(When you press [MENU/SET] on the camera, the QR code is displayed in an enlarged size.)
- When connecting with SSID and password
 - ① Start "Image Shuttle". (→225)
 - ② Select [Wi-Fi].
 - ③ Select the SSID displayed on this unit.
 - ④ Enter the password displayed on the camera (First time connecting only).
 - If you check the item to display the password, you can confirm the password as you enter it.

Operating the Camera by Connecting it to a Smartphone

Changing the connection method

To change the connection method, press [DISP] and select the connection method.

**■ When connecting with [Via Network]****(On the camera)**

- ① Select [Via Network], and then press [MENU/SET].
 - Connect the camera to a wireless access point by following the connection method (→240).

(On your smartphone)

- ② Set the Wi-Fi function to “ON”.
- ③ Select the wireless access point you connected to the camera, and set.
- ④ Start “Image Shuttle”. (→225)

■ When connecting with [Direct]**(On the camera)**

- ① Select [Direct], and then press [MENU/SET].
 - Select [Wi-Fi Direct] or [WPS Connection], and connect the camera to the smartphone by following the connection method (→243).

(On your smartphone)

- ② Start “Image Shuttle”. (→225)

Closing the connection

After use, close the connection with the smartphone.

(On the camera)**1 Press [WIFI].**

(On the recording standby screen, you can also close the connection by pressing **MENU** → **X** [Setup] → [Wi-Fi] → [Wi-Fi Function] → [Yes].)

2 Select [Terminate the Connection].

• A confirmation screen is displayed. Select [Yes], and then press [MENU/SET].

(On your smartphone)**3 Close “Image Shuttle”.**

<Using an iOS device>

From the “Image Shuttle” screen, press the home button on the smartphone to close the app.

<Using an Android device>

From the “Image Shuttle” screen, press the back button on the smartphone twice to close the app.

Operating the Camera by Connecting it to a Smartphone

Connecting to a smartphone using the NFC function

Using the NFC (Near Field Communication) function, the camera and a smartphone can easily exchange the information needed to establish a Wi-Fi connection.

Compatible models:

This function can be used with NFC compatible devices with Android (2.3.3 or above). (Not available in certain models)

- See the instructions of your NFC-compatible smartphone for more information about smartphone operation and settings.

Preparations

(On the camera)

- Set [NFC Operation] to [ON]. (→247)

(On your smartphone)

- Check if your smartphone is a compatible model.
- Set the Wi-Fi function to "ON".
- Install "Image Shuttle" in advance. (→225)

1 Start "Image Shuttle" on your smartphone.**2 While [📷] is displayed on the connection screen of the "Image Shuttle", hold the smartphone close to the camera.****3 Use ◀ to select [Yes], and then press [MENU/SET].****4 Hold the smartphone close to this area of the camera again.**

- When the connection is active, live images captured by the camera will be displayed on your smartphone.
- It may take some time to complete the connection.
- Connected smartphones are registered to the camera.
- From the next time and on, you can connect by performing steps **1** and **2**.

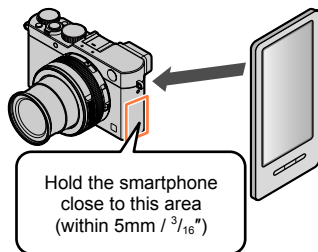

Operating the Camera by Connecting it to a Smartphone

- You can register up to 20 smartphones. If the number of registered smartphones exceeds 20, registrations will be deleted starting from the smartphone touched first.
- If you perform [Reset Wi-Fi Settings], smartphone registration will be deleted.
- If the communication environment is bad, the NFC function may not be usable.
- If there is not a response immediately, shift the position slightly.
- Do not bump your smartphone strongly against the camera.
- See the instructions of your NFC-compatible smartphone for more information about smartphone operation and settings.
- Metal objects between camera and smartphone may interfere with communication. Also, any stickers, etc., near the NFC area may affect communication performance.



- The NFC function cannot be used in the following cases:
 - When the camera is turned off (Including [Sleep Mode])
 - During motion picture recording
 - While recording still pictures (during self-timer countdown)
 - When using [Time Lapse Shot]
 - When using [Stop Motion Animation]
 - When using [Multi Exp.]
 - During motion picture playback, during slide shows, during panorama picture playback, and during continuous playback of group pictures (including pauses in each case)
 - While sending pictures by Wi-Fi
 - When connected to a computer or a printer
- You cannot transfer still pictures in RAW format, or motion pictures with a [Rec Quality] of [4K].

Taking pictures via remote control with a smartphone

1 Connect to a smartphone. (→226)

2 Select [📱] from “Image Shuttle”.

3 Take the pictures.

- The recorded images are saved in the camera.
- When a longer focal length is set, the lens barrel extends, which could cause the camera to change its position if this is not prevented. Make sure to secure the camera in place with a tripod or by other means.
- Some settings are not available.

Operating the Camera by Connecting it to a Smartphone

Playing back pictures in the camera on a smartphone**1 Connect to a smartphone.** (→226)**2 Select [] from “Image Shuttle”.**

- The images captured by the camera are displayed on the smartphone.
- You can switch a picture to be displayed using the icon at the top left on the screen. Select [Leica Image Shuttle] to display a picture saved in the camera.
- When the picture is touched, it is played back at a larger size.

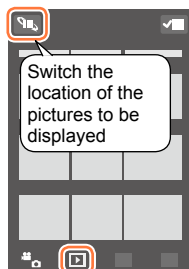
**Saving pictures from the camera to the smartphone****1 Connect to a smartphone.** (→226)**2 Select [] from “Image Shuttle”.****3 Press and hold the picture and drag it to save it on the smartphone.**

- The picture is saved on the smartphone.
- Functions can be assigned to the top, bottom, left and right as you wish.



- You cannot save still pictures in RAW format, or motion pictures with [Rec Quality] of [4K].

Easily transferring pictures from the camera

You can establish a Wi-Fi connection using the NFC function and easily transfer the picture on display through Wi-Fi simply by holding the smartphone close to the camera. Pictures can be transferred as soon as they are recorded, so you can easily transfer them to your friends' and family's smartphones.*

* "Image Shuttle" must be installed to use this function.

Preparations

(On the camera)

- Set [NFC Operation] to [ON]. (→247)
- Set [Touch Sharing] to [ON]. (→247)

(On your smartphone)

- Check if your smartphone is a compatible model.
- Set the Wi-Fi function to "ON".
- Install "Image Shuttle" in advance. (→225)

- 1 On the camera, play back the picture you wish to transfer to a smartphone.**
- 2 Start "Image Shuttle" on the smartphone you are transferring the picture to.**
- 3 While [📷] is displayed on the connection screen of the "Image Shuttle", hold the smartphone close to the camera.**
 - The picture will be transferred to the smartphone.
 - If you are transferring multiple pictures, repeat steps **1** and **3**. (Multiple pictures cannot be transferred in one batch.)
 - It may take several minutes to complete the picture transfer depending on the environment.

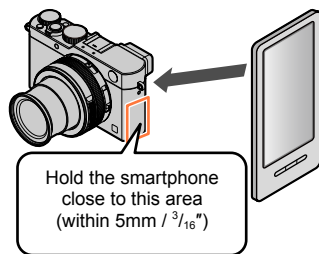

Sending pictures from the camera to social networking services

- 1 Connect to a smartphone. (→226)
- 2 Select [] from “Image Shuttle”.
- 3 Press and hold the picture and drag it to the social networking service, etc.

- The picture will be sent to the social networking service.
- Functions can be assigned to the top, bottom, left and right as you wish.

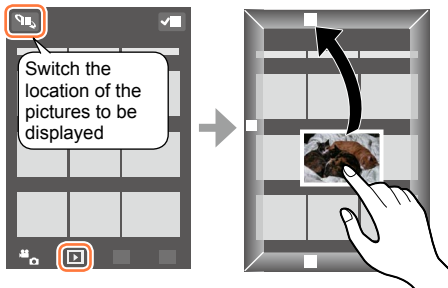

Adding location information to pictures in the camera from a smartphone

You can send the location information acquired from a smartphone to the camera. After the information is sent, you can write it on the pictures in the camera.

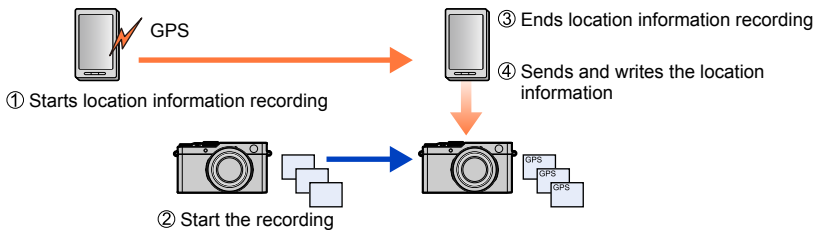

- Location information that is different from the information acquired during recording may be written. Take care regarding the following matters.
 - Set [Home] of [World Time] of the camera to your home area.
 - Once a smartphone starts recording the location information, do not change the [Home] setting of [World Time] of the camera.
- The location information cannot be written to pictures recorded without setting [Clock Set].

Operating the Camera by Connecting it to a Smartphone

■ Starting location information recording

① Operate the smartphone.

- ① Select [📶].
- ② Select [Geotagging].
- ③ Select [▶].



■ Ending location information recording

① Operate the smartphone.

- ① Select [📶].
- ② Select [Geotagging].
- ③ Select [⏸].

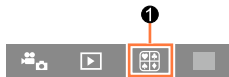

■ Sending and writing the location information

① Connect to a smartphone. (→226)

② Operate the smartphone.

- ① Select [📶].
- ② Select [Geotagging].
- ③ Select [📶].



- Follow the messages on the screen to perform the operation.
- Location information may not be written if there is not enough free space on your card.
- You can also use [Location Logging] in the [Playback] menu to write the sent location information to the pictures.

● Caution:

Remember not to exploit this function in situations where it may violate the privacy, the likeness rights, etc. of the targeted subject. Use at your own risk.

- On the smartphone, you can set the acquisition interval of location information and check its transfer status. Refer to [Help] in the "Image Shuttle" menu for details.
- (When using "Image Shuttle" for iOS)
If you press the Home or On/Off button of a smartphone while location information recording is in progress, recording is stopped.

Operating the camera to send pictures to a smartphone

■ Sending method, and pictures that can be sent

	JPEG	RAW	MP4
[Send Images While Recording] (→237)	○	—	—
[Send Images Stored in the Camera] (→238)	○	—	○*

*Excluding motion pictures recorded with the [Rec Quality] [4K]

- Some images may not be played back or sent depending on the device.
- See the instructions of the destination device for more information about picture playback.
- For more details about picture sending methods. (→246)

Preparation

Install "Image Shuttle" in advance. (→225)

[Send Images While Recording]**1 Set the menu item:**

WIFI → [New Connection] → [Send Images While Recording]

2 Select [Via Network] or [Direct], and then press [MENU/SET].**■ When connecting with [Via Network]****(On the camera)**

① Connect the camera to a wireless access point. (→240)

(On your smartphone)

② Set Wi-Fi function to "ON".

③ Select the wireless access point you connected to the camera, and set.

④ Start "Image Shuttle". (→225)

■ When connecting with [Wi-Fi Direct] or [WPS Connection] in [Direct]**(On the camera)**

① Connect the camera to a smartphone. (→243)

(On your smartphone)

② Start "Image Shuttle". (→225)

■ When connecting with [Manual Connection] in [Direct]Perform step **2**. (→226)**3 Select the device you wish to connect to.**

- When the connection is established, the confirmation screen for the transmission setting is displayed. Check the setting, and then press [MENU/SET]. To change the send setting, press [DISP]. (→246)

4 Take still pictures.

- The still pictures are sent automatically after taking them.
- To change the setting or disconnect, press [WIFI].
You cannot change the settings while sending still pictures. Wait until the transmission is complete.

(You can also close the connection by pressing **MENU** → ✕ [Setup] → [Wi-Fi] → [Wi-Fi Function] → [Yes].)

[Send Images Stored in the Camera]**1 Set the menu item:**

WIFI → **[New Connection]** → **[Send Images Stored in the Camera]**

2 Select [Via Network] or [Direct], and then press [MENU/SET].**■ When connecting with [Via Network]****(On the camera)**

① Connect the camera to a wireless access point. (→240)

(On your smartphone)

② Set Wi-Fi function to "ON".

③ Select the wireless access point you connected to the camera, and set.

④ Start "Image Shuttle". (→225)

■ When connecting with [Wi-Fi Direct] or [WPS Connection] in [Direct]**(On the camera)**

① Connect the camera to a smartphone. (→243)

(On your smartphone)

② Start "Image Shuttle". (→225)

■ When connecting with [Manual Connection] in [Direct]

Perform step 2. (→226)

3 Select the device you wish to connect to.

- When the connection is established, the confirmation screen for the transmission setting is displayed. Check the setting, and then press [MENU/SET]. To change the send setting, press [DISP]. (→246)

4 Select [Single Select] or [Multi Select].**[Single Select]**

① Select the picture.

② Press [MENU/SET].

[Multi Select]

① Select the picture (repeat).

- If selected again, the setting will be canceled.

② Select [OK].

- The number of pictures that can be sent by [Multi Select] is limited.

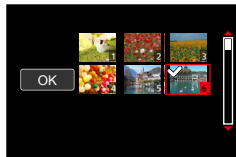

- A confirmation screen is displayed. If you select [Yes], the operation is executed.
- To change the send setting, press [DISP].
- To close the connection, select [Exit].

About Connections

After selecting the Wi-Fi function, select the connection method.

If you are out and unable to use your wireless access point, or temporarily connecting to equipment you do not ordinarily use, or in a similar situation, it is convenient to make a direct connection.

If you are connecting with the same settings as used previously, you can quickly start using the Wi-Fi function by connecting with [Select a destination from History] or [Select a destination from Favorite].



Connection method	Description	
[Via Network]	Connects through a wireless access point.	(→240)
[Direct]	Your equipment connects directly to the camera.	(→243)

[Via Network] Connecting via a wireless access point

For selecting a connection method to the wireless access point.

- WPS refers to a function that allows you to easily configure the settings related to the connection and security of wireless LAN devices. To check if the wireless access point you are using is compatible with WPS, refer to the instructions of the wireless access point.

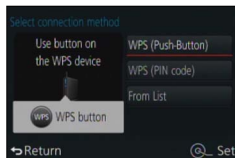

Connection method	Description
[WPS (Push-Button)]	<p>For saving a push button type wireless access point that is compatible with Wi-Fi Protected Setup™ with a WPS mark.</p> <ol style="list-style-type: none"> 1 Press the wireless access point WPS button until it switches to WPS Mode. <ul style="list-style-type: none"> • Refer to the wireless access point instructions for details.
[WPS (PIN code)]	<p>For saving a PIN code type wireless access point that is compatible with Wi-Fi Protected Setup with a WPS mark.</p> <ol style="list-style-type: none"> 1 Select the wireless access point you are connecting to. 2 Enter the PIN code displayed on the camera screen into the wireless access point. 3 Press [MENU/SET]. <ul style="list-style-type: none"> • Refer to the wireless access point instructions for details.
[From List]	<p>Select this option when you are not sure about the WPS compatibility, or when you want to search for and connect to a wireless access point.</p> <ul style="list-style-type: none"> • For details: (→241).

If you are not sure about the WPS compatibility (connecting by [From List])

Search for available wireless access points.

- Confirm the encryption key of the selected wireless access point if the network authentication is encrypted.
- When connecting by [Manual Input], confirm the SSID, the network authentication type, the encryption type, and the encryption key of the wireless access point you are using.

1 Select the wireless access point you are connecting to.

- Pressing [DISP] will search for a wireless access point again.
- If no wireless access point is found, refer to "When connecting with [Manual Input]" (→242).

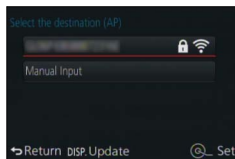

2 (If network authentication is encrypted) Enter the encryption key.

- For details on how to enter characters, refer to "Entering Text" (→52).

■ When connecting with [Manual Input]

- ① On the screen of step **1** of “If you are not sure about the WPS compatibility (connecting by [From List])”, select [Manual Input]. (→241)
- ② Enter the SSID of the wireless access point you are connecting to, then select [Set].
 - For details on how to enter characters, refer to “Entering Text” (→52).
- ③ Select the network authentication type.
 - For information on network authentication, see the instructions of the wireless access point.
- ④ Select the encryption type.
 - The type of settings that can be changed may vary depending on the details of network authentication settings.

Network authentication type	Encryption types that can be set
[WPA2-PSK] / [WPA-PSK]	[TKIP] / [AES]
[Common Key]	[WEP]
[Open]	[No Encryption] / [WEP]

(When an option other than [No Encryption] is selected)

- ⑤ Enter the encryption key

- Check the wireless access points instructions and settings when a saving wireless access point.
- If no connection can be established, the wireless access point's radio transmission may be too weak. Refer to “Message displays” (→269) and “Q&A Troubleshooting” (→280) for details.
- Transmission speed may decrease, or may not be usable depending on the environment it is used in.

[Direct] Connecting directly

You can select the connection method to your equipment. Select a connection method with which your equipment is compatible.



Connection method	Description	
[Wi-Fi Direct]*1	<ol style="list-style-type: none"> 1 Set the device to Wi-Fi Direct™ mode. 2 Select [Wi-Fi Direct]. 3 Select the device to connect to. <ul style="list-style-type: none"> • Read the instructions of your device for details. 	
[WPS Connection]*2	[WPS (Push-Button)] <ol style="list-style-type: none"> 1 Select [WPS (Push-Button)]. 2 Set the device to WPS mode. <ul style="list-style-type: none"> • You may have to wait longer for a connection when pressing [DISP] on the camera. 	
	[WPS (PIN code)] <ol style="list-style-type: none"> 1 Select [WPS (PIN code)]. 2 Enter the PIN code of the device into the camera. 	
[Manual Connection]	<ol style="list-style-type: none"> 1 Enter the SSID and password into the device. The SSID and password are displayed on the connection waiting screen of the camera. 	<p>QR Code SSID and Password</p>

*1 To connect the camera with [Wi-Fi Direct], Android OS 4.0 or above is required and the device must be compatible with Wi-Fi Direct™.

*2 WPS refers to a function that allows you to easily configure the settings related to the connection and security of wireless LAN devices.

Connecting quickly with the same settings as used previously ([Select a destination from History] / [Select a destination from Favorite])

The camera registers the times you used the Wi-Fi function. You can register items in this History to Favorite.

You can easily connect with the same settings as used previously by connecting from History or Favorite.

1 Press [WIFI].

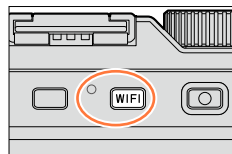

2 Select [Select a destination from History] or [Select a destination from Favorite].

Item	Description
[Select a destination from History]	Connects using the same settings as used previously.
[Select a destination from Favorite]	Connects using settings registered in Favorite.

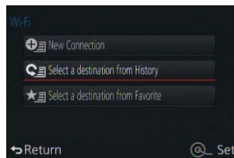

3 Select the desired connection setting.

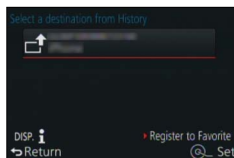

Registering History items to Favorite

1 Press [WIFI].

2 Select [Select a destination from History].

3 Select the item you wish to register and press ►.

4 Enter a registration name.

- For details on how to enter characters, refer to "Entering Text" (→52).
- Up to 30 characters can be entered. A double-byte character will be treated as two characters.

Editing items registered in Favorite

- 1 Press [WIFI].
- 2 Select [Select a destination from Favorite].
- 3 Select the Favorite item you wish to edit, and then press ►.
- 4 Select the item.

Item	Description
[Remove from Favorite]	—
[Change the Order in Favorite]	For selecting the destination
[Change the Registered Name]	<ul style="list-style-type: none"> • For details on how to enter characters, refer to "Entering Text" (→52). • Up to 30 characters can be entered. A double-byte character will be treated as two characters.



Registering and saving frequently used Wi-Fi connection settings to Favorites

- The number of settings that can be saved in the history is limited. We recommend that you register and save frequently used Wi-Fi connection settings to Favorite. (→244)



Checking connection details of History or Favorite

- When selecting History or Favorite items, you can view connection details by pressing [DISP].
-
- Performing [Reset Wi-Fi Settings] deletes content registered in History and Favorite.

Settings for sending pictures

When sending pictures, first select [New Connection], then the method of sending pictures.

After completing connecting, you can also change the sending settings, such as the resolution of the pictures to be sent.

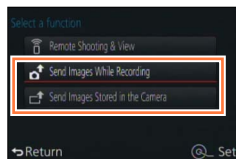

[Send Images While Recording]

A picture can be automatically sent to a specified device immediately after taking it.

- [Wi-Fi] is displayed on the recording screen while connected by [Send Images While Recording], and [P] is displayed while files are being sent.
- If you turn off the camera before you have completed sending, or if you close the Wi-Fi connection, or in similar situations, unsent files will not be resent.
- You may not be able to delete files or use the [Playback] menu while sending.

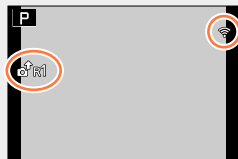

- Motion pictures cannot be sent.

[Send Images Stored in the Camera]

You can select and send recorded images.

- Details of the [Playback] menu [Favorite] or [Print Set] settings will not be sent.



The function is not available in the following cases:

- Some images taken with a different camera may not be able to be sent.
- Images that have been modified or edited with a computer may not be able to be sent.

Changing the settings for sending images

After completing connecting, you can change the sending settings, such as the resolution of the pictures to be sent, by pressing [DISP].

Item	Description
[Size]	For changing the resolution of the image to send. [Original] / [Change] <ul style="list-style-type: none"> • You can select the resolution for [Change] from [M], [S], or [VGA]. The aspect ratio does not change.

[Wi-Fi Setup]

For configuring the settings required for the Wi-Fi function.
[Wi-Fi Setup] cannot be changed when connected to Wi-Fi.

1 Set the menu item:

MENU → **X** [Setup] → [Wi-Fi] → [Wi-Fi Setup] → **Desired setting**

Item	Description
[Device Name] You can change the name of the camera.	① Press [DISP]. ② Enter the desired device name. <ul style="list-style-type: none"> Refer to “Entering Text” (→52) for information on how to enter text. Up to 32 characters can be entered.
[NFC Operation] Makes NFC function setting.	[ON]: The NFC function is available. [OFF]
[Touch Sharing] Sets the operation to be performed when a Wi-Fi connection is established using the NFC function.	[ON]: When a Wi-Fi connection is established using the NFC function while playing back a single picture, the picture (1 picture) is transferred. [OFF]
[Wi-Fi Password] To prevent incorrect operation or use of the Wi-Fi function by a third party and to protect saved personal information, it is recommended that you protect the Wi-Fi function with a password.	Setting a password will automatically display the password input screen when the Wi-Fi function is used. [Setup]: Enter any 4-digit number as the password. Close the menu after changing settings. [Delete]: A confirmation screen is displayed. It is executed when [Yes] is selected. Exit the menu after it is executed. <hr/> <ul style="list-style-type: none"> For details on how to enter characters, refer to “Entering Text” (→52). Make a copy of the password. If you forget the password, you can reset it with [Reset Wi-Fi Settings] in the [Setup] menu, however other settings will also be reset.
[Network Address] Displays the MAC and IP address of this unit.	<ul style="list-style-type: none"> A “MAC Address” is a unique address that is used to identify network equipment. “IP address” refers to a number that identifies a computer connected to a network such as the Internet. Usually, the addresses for homes are automatically assigned by the DHCP function such as a wireless access point. (Example: 192.168.0.87)
[Approved Regulations]* Displays certification note	The technical compliance standard authentication number is displayed.

* With camera model 18 471

Enjoying 4K Motion Pictures

Viewing 4K motion pictures

■ Viewing on TV screen

When you connect the camera to a 4K-compatible TV and play back a motion picture recorded with the [Rec Quality] [4K], you can enjoy extremely high-detail motion pictures. Although resolution output will be lower, you can also play back 4K motion pictures by connecting to a high-definition TV and other devices that do not have 4K support.

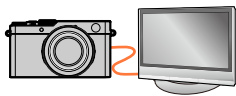

Preparation

When motion pictures are recorded with the [Rec Quality] set to [4K], set [HDMI Mode] (→48) to [AUTO] or [4K].

- ① Connect the camera to a 4K-compatible TV using an HDMI micro cable and display the playback screen. (→249)
 - When the [HDTV Link] setting on the camera is set to [ON] and the camera is connected to a HDTV Link (HDMI)-compatible TV, it automatically switches its input and the playback screen is displayed. For details, refer to (→251).
 - You can also play back motion pictures by inserting the card in a 4K-compatible TV equipped with a SD card slot.
 - Read the instructions for the TV.

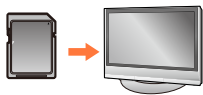

■ Viewing 4K motion pictures on a computer screen

- To play back and edit 4K motion pictures, a high-performance computer environment is required.



Storing 4K motion pictures

■ Storing 4K motion pictures on your computer

Still/motion pictures can be copied from the camera to your computer by connecting the two. For details, refer to (→253).

Viewing on a TV Screen

You can view pictures on a TV screen by connecting your camera to your TV with an AV or HDMI micro cable.

- Compatible cables are available from specialist photo dealers. Make absolutely sure to use only cables compatible with this camera.

Preparation

Turn off both camera and TV.

1 Connect the camera to the TV.

Make sure to use the right plugs for the differing sockets, that the plugs are aligned correctly and that they are inserted straight. (Otherwise the connectors may be bent out of shape which may cause malfunction or even the camera to be damaged.)

■ To connect with an HDMI micro cable

An HDMI micro cable can be used to enable viewing of still and motion pictures in high-resolution.

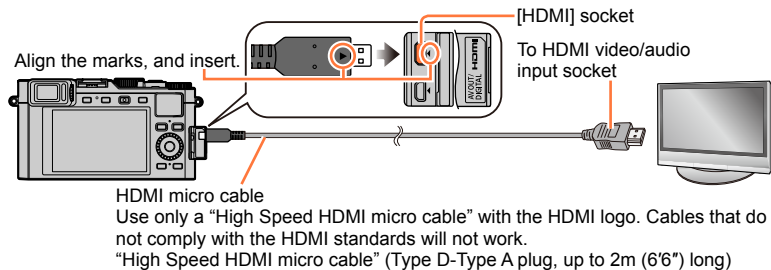

■ To connect with an AV cable

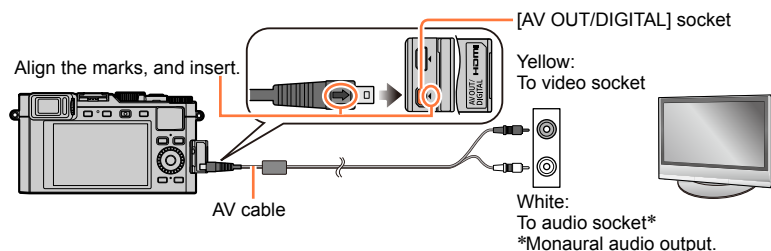

2 Turn on the TV and switch the TV input source to match the connection socket.

3 Turn on the camera and press [▶].

■ To connect with an HDMI micro cable

- Check the [HDMI Mode]. (→48)
- To play back 24p motion pictures, set [HDMI Mode] to [AUTO]. Otherwise, the picture is not output at 24 frames per second.
- Bars may appear at the sides or at the top and bottom of the screen, depending on the aspect ratio setting.
- Cables that do not comply with HDMI standards will not work.
- When an HDMI micro cable is connected, pictures are not displayed on the screen.
- HDMI output will be canceled if the supplied USB connection cable is connected simultaneously.
- When an AV and an HDMI micro cable are connected at the same time, no picture is output from the AV cable.
- Pictures may be momentarily distorted immediately after commencing playback or pausing on certain TV.
- Audio output is stereo.
- Read the instructions for the TV.

■ To connect with an AV cable

- Check the [TV Aspect]. (→47)
- Compatible AV cables are available from specialist photo dealers. Make absolutely sure to use only cables compatible with this camera.
- You can play back pictures on TVs in other countries (regions) which use the NTSC or PAL system. You can find [Video Out] setting in [TV Connection] from the [Setup] menu. (With camera models 18 470 / 18 473)
- Pictures rotated to portrait may be blurred slightly.
- Change picture mode settings on the TV if aspect ratios are not displayed correctly.
- The viewfinder display cannot be used.
- Read the operating instructions for the TV.

**The recorded pictures can be played back on a TV with an SD Memory Card slot**

- Proper playback (aspect ratio) will depend on the TV used for viewing.
- The file format of the motion pictures that can be played back differs depending on the TV model.
- You may not be able to play back panorama pictures. Also you cannot perform automatic scrolling playback of panorama pictures.
- For cards compatible with playback, refer to the operating instructions of the TV.

HDTV Link (HDMI)

What is HDTV Link (HDMI)?

- HDTV Link is a function that automatically links this camera to HDTV Link-compatible devices by connecting HDMI micro cables for enabling easy operation with the HDTV remote control. (Some operations are not available.)
- HDTV Link (HDMI) is an exclusive function added to the industry-standard HDMI control functions known as HDMI CEC (Consumer Electronics Control). Operation is not guaranteed when connecting with other HDMI CEC-compatible devices. Refer to your product's instructions to verify compatibility with HDTV Link (HDMI).

Preparation

Set [HDTV Link] to [ON]. (→49).

- 1 Connect the camera to an HDTV Link (HDMI)-compatible TV with an HDMI micro cable.** (→249)
- 2 Turn on the camera, and then press [▶].**
- 3 Operate with the remote control for the TV.**
 - Operate with reference to the operation icons displayed on the screen.

Other related operations**Turning the camera OFF**

- The camera can also be turned off when the TV is turned off with the remote control.

Automatic input select

- This function automatically switches the TV input to the camera screen whenever the camera is turned on while it is connected via an HDMI micro cable. The TV can also be switched on via the camera from Standby Mode (if "Power on link" on the TV is set to "on", provided, it has this function).
 - If HDTV Link (HDMI) does not function correctly (→291)
- Use a "High Speed HDMI micro cable" with the HDMI logo. Cables that do not comply with the HDMI standards will not work.
"High Speed HDMI micro cable" (Type D-Type A plug, up to 2m (6'6") long)
Compatible HDMI micro cables are available from specialist photo dealers. Make absolutely sure to use only cables compatible with this camera.
- If you do not know if your TV is HDTV Link (HDMI)-compatible, see the TV's instructions.
 - When HDTV Link is activated, the [HDMI Mode] setting of the camera is automatically recognized.
 - If the [HDTV Link] setting on the camera is [ON], operations via the camera buttons will be limited.
 - Ensure that the TV you are connecting to has been set up to enable HDTV Link (HDMI) (consult your TV's instructions for details).

Copying the Recorded Image Data to a Computer

With card readers (built-in / external)

- Some computers can read directly from the card taken from the camera, others require the use of an external card reader. For details, refer to the instructions of the respective devices.
- If the computer being used does not support SDXC Memory Cards, a message prompting you to format may appear. (Doing so would cause all recorded image data to be erased, so make sure to select [NO].)
- With an external card reader, make sure it supports the type of card being used.

With a computer connected directly to the camera (using the available software)

■ Computers that can be used:

Any model capable of recognizing a mass storage device.

- Windows support: Windows XP/Windows Vista/Windows 7/Windows 8/ Windows 8.1
- Mac support: OS X v10.5 to v10.9

Using the Adobe® Photoshop® Lightroom® software, you can import the image data for still and motion pictures recorded with this camera in all file formats to a computer.

■ Installing the software

To utilize the software, it must be installed first. Three preparatory steps are necessary:

① Register your camera on the Leica Camera AG homepage.

- Open an account at <http://owners.leica-camera.com>. As a result, you will receive access to the "Owners area".
- Register your camera at "My products" by entering its serial number. Do so by following the respective instructions.
- Then select "...software download...". You will be requested to enter the TAN code which you will find on a sticker on the Guarantee card.
 - The key with which you can activate the software will be sent to you by email.

② Install the software to your computer.

③ Activate the software with the key (numbers) you have received.

- Do so by following the respective instructions appearing after opening the software.
- For details on how to operate the software, refer to the online assistance.

Copying the Recorded Image Data to a Computer

Copying the data

Preparations

- Turn on the camera and the computer.

1 Connect camera and camera with the supplied USB cable.

- Make sure to use the right plugs for the differing sockets, that the plugs are aligned correctly, and that they are inserted straight. (Otherwise the connectors may be bent out of shape which may cause malfunction or even the camera to be damaged.)
- Do not use any other USB cables except a genuine Leica USB cable of the supplied type. Using cables other than the above may cause a malfunction.

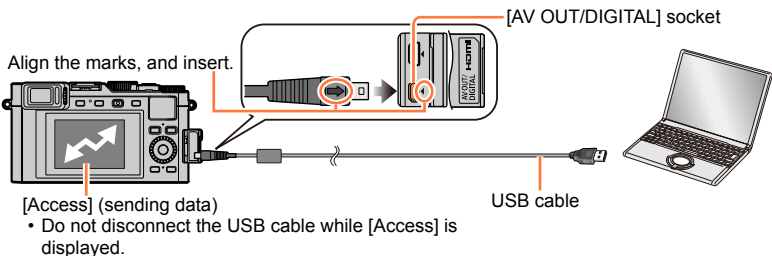

2 Use ▲ ▼ to select [PC], and then press [MENU/SET].

- Setting the [USB Mode] to [PC] removes the need to make the setting each time the camera is connected to the computer.

3 Copy the images to the computer using the installed software.

■ For PTP mode

The camera can be connected to your computer even if [USB Mode] (→47) is set to [PictBridge(PTP)].

- Only picture output can be performed.
- If you cannot connect to your computer in PTP mode, set [USB Mode] to [PC] and reconnect.
- It may not be possible to import if there are 1,000 or more pictures on the card.
- Motion pictures or RAW pictures cannot be read.

Copying the Recorded Image Data to a Computer

■ Copying to your computer without using “Adobe® Photoshop® Lightroom®”

You can save pictures to use on your computer by dragging and dropping folders and files into separate folders on your computer.

- A card used in this camera contains the following files (folder structure).

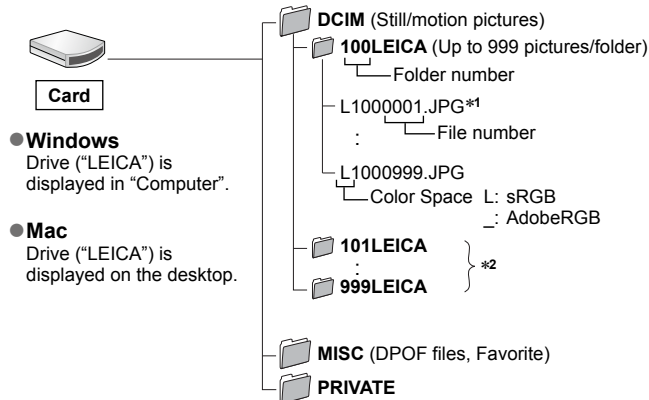

*1 .JPG: Still pictures

.RWL: Still pictures recorded in RAW file

.MP4: [MP4] Motion Pictures

*2 New folders are created in the following cases:

- When there is a picture with file number 999 inside the folder.
- When using cards already containing the same folder number (for example, pictures taken with other cameras, etc.).
- When recording after performing [No.Reset]. (→50)

- Turn off the camera before inserting or removing memory cards.
- Use a sufficiently charged battery. When the battery starts to run out during communications, a warning beep sounds. Cancel communication via your computer immediately.
- For more details, consult your computer instructions.

Storing Recorded Still and Motion Pictures on a Recorder

Follow the correct method for your device.

Copying by inserting the card into the recorder

You can copy pictures using equipment (such as Blu-ray disc recorders) with support for each file format.

Dubbing playback pictures via an AV cable

You can transfer or copy the pictures played back on the camera to a recorder, disc, video tapes, or other media using the standard picture quality. This method is useful as it allows dubbing to be performed even with devices that are not compatible with high definition images. Audio will be monaural.

1 Connect the camera with the recording equipment with an AV cable.

- Make sure to use the right plugs for the differing sockets, that the plugs are aligned correctly, and that they are inserted straight. (Otherwise the connectors may be bent out of shape which may cause malfunction or even the camera to be damaged.)

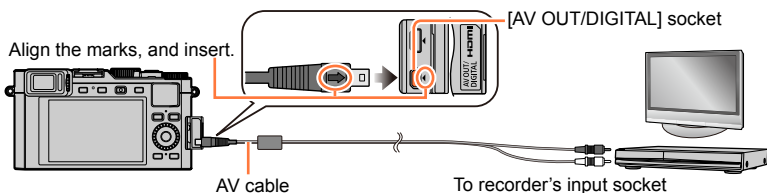

2 Start recording on the recorder.

3 Start playback on the camera.

- To stop recording (dubbing), stop the recording on your recorder first before stopping the playback on the camera.

- Compatible AV cables are available from specialist photo dealers. Make absolutely sure to use only cables compatible with this camera.
- When using a TV with a 4:3 aspect ratio, always change the camera's [TV Aspect] setting (→47) to [4:3] before dubbing. Motion pictures copied in the [16:9] setting will appear vertically stretched when viewed on a 4:3 TV screen.
- For details on dubbing and playback methods, refer to your recorder's operating instructions.

Printing pictures

You can connect directly to a PictBridge-compatible printer for printing.

- Some printers can print directly from the camera's memory card.
- For details, see the instructions for your printer.

Preparations

- Adjust the print quality or other settings on your printer, as needed.
- Turn on the camera and printer.

1 Connect camera to printer.

- Make sure to use the right plugs for the differing sockets, that the plugs are aligned correctly and that they are inserted straight. (Otherwise the connectors may be bent out of shape which may cause malfunction or even the camera to be damaged.)
- Do not use any other USB cables except a genuine Leica USB cable of the supplied type. Using cables other than the above may cause a malfunction.

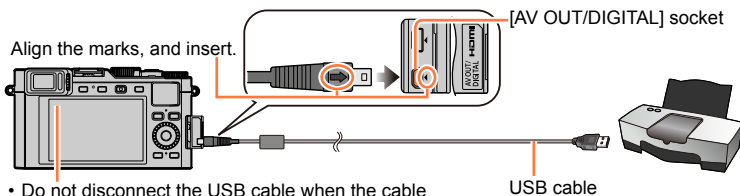

- Do not disconnect the USB cable when the cable disconnection icon [🔌] is displayed (may not be displayed with some printers).

2 Use ▲ ▼ to select [PictBridge(PTP)], and then press [MENU/SET].

3 Use ◀ ▶ to select a picture, and then press [MENU/SET].

4 Use ▲ to select [Print start], and then press [MENU/SET].

(Print settings (→260))

■ To cancel print

Press [MENU/SET].

Printing multiple pictures

Multiple pictures are printed at one time.

1 Press **▲** to select **[Multi Print]** in step 3. (→257)

2 Use **▲ ▼** to select the item and press **[MENU/SET]**.

- **[Multi Select]:**
 - ① Scroll between pictures with **▲ ▼ ◀ ▶**, select pictures to print with **[MENU/SET]**. (Press **[MENU/SET]** again to release selection.)
 - ② Use **◀** to select **[OK]**, and then press **[MENU/SET]**.
- **[Select All]:** Prints all pictures.
- **[Print Set (DPOF)]:** Prints the pictures selected in **[Print Set]**. (→217)
- **[Favorite]:** Prints the pictures selected as **[Favorite]**. (→216)

3 Use **▲** to select **[Print start]**, and then press **[MENU/SET]**.

(Print settings (→260))

- Select **[Yes]** if the print confirmation screen is displayed.

- The group pictures are displayed one by one instead of all at the same time.
- Turn off the camera before inserting or removing memory cards.
- Disconnect the USB cable after printing.
- Use a sufficiently charged battery. When the battery starts to run out during connection, a warning beep sounds. Cancel printing and disconnect the USB cable.
- An orange “●” displayed during printing indicates an error message.
- Printing may be done on several sheets if printing a large amount of pictures.
(Remaining sheets display may differ from the number of pictures set for printing.)



The function is not available in the following cases:

- Motion pictures cannot be printed.
- Still pictures recorded in a RAW file cannot be printed. (The still pictures recorded in JPEG file format at the same time as the RAW file can be printed.)

Printing with date and text

Time and date can be set to be printed on the picture when taking the picture by activating the [Text Stamp] function in the [Playback] menu. (→209)

■ Printing date without [Text Stamp]

Printing in a store:

Only the recording date can be printed. Request date printing in the store.

- Making [Print Set] (→217) settings on the camera in advance allows settings for numbers of copies and date printing to be designated before giving the card to the store.
- When printing still pictures with an aspect ratio of 16:9, check in advance that the store can accept this size.

Using a printer:

The recording date can be printed by setting [Print Set] on the camera, or by setting [Print with Date] (→260) to [ON] when connecting to a printer compatible with date printing.

Making print settings on the camera

Setting options include the number of printed pictures and their size. Make the settings before selecting [Print start].

1 Use ▲ ▼ to select the item, and then press [MENU/SET].

Item	Settings
[Print with Date]	[ON] / [OFF]
[Num.of prints]	For setting the number of pictures (up to 999 pictures)
[Paper Size]	When [📄] is selected, the printer settings take priority.
[Page Layout]	[📄] (printer takes priority) / [📄] (1 picture, no border) / [📄] (1 picture, with border) / [📄] (2 pictures) / [📄] (4 pictures)

2 Use ▲ ▼ to select the setting, and then press [MENU/SET].

- When setting [Print with Date] to [ON], check the date printing settings on the printer (printer settings may be prioritized).
- To print a picture on which text or a date has been stamped, set [Print with Date] to [OFF]. (The still picture is printed with the date superimposed on it.)
- Items may not be displayed if incompatible with the printer.
- To arrange [📄] "2 pictures" or [📄] "4 pictures" on the same sheet, set the number of prints to 2 or 4.
- To print to paper sizes/layouts not supported by this camera, set to [📄] and make settings on the printer. (Consult your printer's instructions.)
- Even with completed [Print Set] settings, dates may not be printed, depending on the shop or printer used.

Using Optional Flash Units

When you use a flash unit such as the Leica CF22 (available as accessory →13), you will have a longer effective flash range than with the supplied flash unit.

Preparation

Set the camera [ON/OFF] switch to [OFF].

Removing the hot shoe cover

The hot shoe cover is inserted in the hot shoe at the time of purchase.

Remove the hot shoe cover by simultaneously pressing it in the direction indicated by arrow ① and pulling it in the direction indicated by arrow ②.

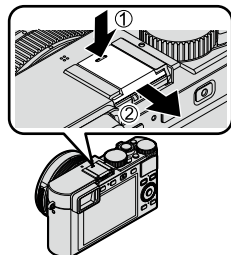

- Be sure to insert the hot shoe cover when the hot shoe is not in use.
- Keep the hot shoe cover in a safe place after removing it so that you do not lose it.

■ Using compatible flash units

- ① Mount the flash unit in the hot shoe and then turn on camera and flash.
- ② Set the menu item:

MENU → [Rec] → [Flash]

- ③ Press **▲▼** to select [Flash Mode], and then [MENU/SET].
- ④ Press **▲▼** to select the item, and then [MENU/SET].
 - While the external flash is connected, the following icons are displayed.
 - ⚡: Flash ON
 - ⚡S: Flash Slow Sync.
 - Ⓞ: Flash OFF

When using non-dedicated flash units









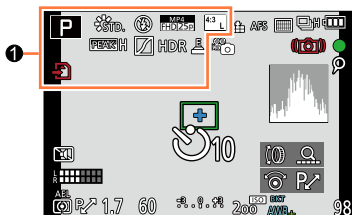

- It is necessary to set the exposure on the flash unit itself when such a unit is used. When you want to use it in its Auto mode, use one that allows you to set the aperture value and ISO Sensitivity to match the settings on the camera.
 - Set the camera to [Aperture-Priority] or [Manual Exposure] Mode and then set the same aperture value and ISO Sensitivity on the flash unit. (In [Shutter-Priority] and [Program AE] modes, the proper exposure cannot be achieved because the camera changes the aperture value, and the flash unit does not receive this information.)
-
- You can set the aperture value, the shutter speed and the ISO Sensitivity on the camera even when a flash unit is attached.
 - Some commercially available flash units have sync terminals with high-voltage or reversed polarity. If such units are used, they could cause a malfunction or hinder normal operation of the camera.
 - If you use flash units dedicated to other camera makes, they may not operate normally or they may be damaged. Do not use them.
 - Even if an attached flash unit is turned off, the camera may enter the flash mode. When you are not using the flash unit, detach it.
 - Detach the flash unit when you carry the camera.
 - Be sure to hold both the camera and the flash unit when it is attached to the camera. If you hold only the flash unit, it could become detached from the camera.
 - If the White Balance is set to [☐] when flash is used, perform fine adjustment of the White Balance if the recording results are not satisfactory. (→105)
 - If you record at close range with the lens set to a short (Wide) focal length, light from the flash may be blocked by the lens, darkening the lower part of the picture.
 - Refer to the instructions of the flash unit for further details.



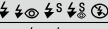



Monitor/Viewfinder Displays

- The following images are examples of when the display screen is set to  (monitor style) in the monitor.

In recording



	Recording mode (→59)
	Motion picture recording mode (→58)
	Motion picture recording mode when [4K PHOTO] is set to [ON] (→192)
C1	Custom Set (→60)
	Panorama picture recording mode (→150)
	[Photo Style] (→100)
	Flash mode (→181, 261)
	Flash triggering (→183)
	Rec Format/[Rec Quality] (→185)
	Aspect Ratio/Resolution (→108)
	Card (displayed only during recording) (→25)
	Panorama Direction (→150)
EXPS	Types of picture effects (Filter) (→89)
	Picture effect (Filter) adjustment display (→91)

XXmXXs	Elapsed recording time*1 (→187)
	Simultaneous recording indicator (→195)
	Automatic switching between viewfinder and monitor (→54)
	[Peaking] (→130)
	[Highlight Shadow] (→102)
HDR	[HDR] (→112)
	[Multi Exp.] (→160)
	Electronic shutter (→140)

*1 [m] and [s] indicate "minutes" and "seconds".

*2 With camera models 18 471 / 18 472

*3 With camera models 18 470 / 18 473

Monitor/Viewfinder Displays

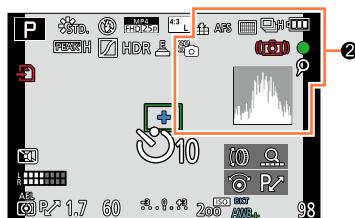

②

	RAW [Quality] (→109)
AFS AFF AFC MF	Focus Mode (→114)
	AF Mode (→115)
	[Face Recog.] (→163)
AFL	AF Lock (→133)
	Series exposures (→142)
	[Auto Bracket] (→145)
	[Aspect Bracket] (→147)
	Self-timer (→148)
	Panorama Direction (→150)
	Battery capacity (→21)
	Picture Mode (Still picture priorities) (→195)
AF	Macro recording (→126)
	Stabilizer (→169)
	Camera shake alert (→169)

	Recording state (Flashes red./ Focus (Lights green.) (→56)
	Focus (Under low illumination) (→56)
	Wi-Fi connection status
	[4K PHOTO] marker (→193)
	[Time Lapse Shot] (→153)
	[Stop Motion Animation] (→156)
	Histogram (→64)

Monitor/Viewfinder Displays

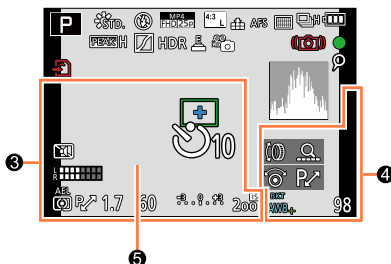

3

Destination settings / Elapsed travel days*
(→42)

Name* (→166)

Age in years/months* (→166)

Current date/time*

World time*: ✈️ (→41)

	AF area (→56, 121)
	Spot metering target (→139)
	Self-timer* (→148)
	[Silent Mode] (→162)
	[Mic Level Disp.] (→197)
AEL	AE Lock (→133)
	Exposure metering mode (→139)
P	Program Shift (→81)
1.7	Aperture value (→56)
60	Shutter speed (→56)
-3 . 0 . +3	Exposure compensation value (→135)
	Light balance (→87)
200	ISO Sensitivity (→136)

4

[Dial Guide] (→18)

BKT
AWB **White Balance Bracketing**
(→106)

White Balance Fine Adjustment
(→105)

White Balance (→103)

98 **Number of recordable pictures***
(→27)

R8m30s **Available recording time***
(→28)

5

Shutter speed/aperture indication (→81)

Zoom (→171, 175)

*1 [m] and [s] indicate "minutes" and "seconds".

*2 This is displayed for about 5 seconds when the camera is turned on, after setting the clock and after switching from Playback to Recording Mode.

*3 This is displayed during countdown.

*4 It is possible to switch the display between the number of recordable pictures and available recording time with the [Remaining Disp.] setting in the [Custom] menu.

■ On-monitor recording information

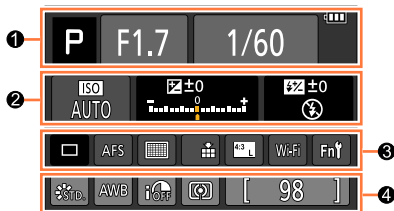

1		Recording mode (→59)
		Program Shift (→81)
		Motion picture recording mode (→58)
		Motion picture recording mode when [4K PHOTO] is set to [ON] (→192)
	C1	Custom Set (→60)
		Panorama picture recording mode (→150)
	F1.7	Aperture value (→56)
	1/60	Shutter speed (→56)
	TIME	T (time) recording (→87)
		Battery capacity (→21)
		Card (displayed only during motion picture recording) (→25)

2		ISO Sensitivity (→136)
		Exposure compensation value (→135)
		Light balance (→87)
		Flash Mode (→181, 261)
		Flash triggering (→183)

3		Single (→141)
		Series exposures (→142)
		[Auto Bracket] (→145)
		[Aspect Bracket] (→147)
		Self-timer (→148)
		Panorama Direction (→150)
	AFS AFF AFC MF	Focus mode (→114)
		AF Mode (→115)
		[Quality] (→109)
		Rec Format/[Rec Quality] (→185)
		Aspect Ratio/Resolution (→108)
	Wi-Fi	Wi-Fi (→222)
	Fn	Function button setting (→37)

4		[Photo Style] (→100)
		[White Balance] (→103)
		[i.Dynamic] (→111)
		Exposure metering mode (→139)
	98	Number of recordable pictures (→27)
	R8m30s	Available recording time*1 (→28)

*1 [m] and [s] indicate "minutes" and "seconds".

*2 With camera models 18 471 / 18 472

*3 With camera models 18 470 / 18 473

In playback

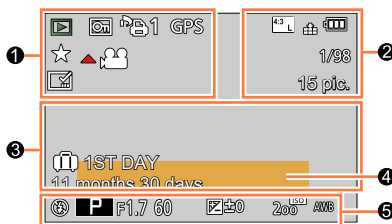

1		Playback mode (→203)
		Protected picture (→218)
		Number of prints (→217)
	GPS	With location information (→204)
		Favorites (→216)
		Cable disconnect prohibit icon (→257)
		Motion picture playback (→70)
		Panorama picture playback (→152)
		Continuous playback of exposure series group (→198)
		Continuous playback of Time Lapse Shot picture group (→198)
		Continuous playback of stop motion animation group (→198)
		Text stamped display (→209)
	XXmXXs	Elapsed playback time *1 (→70)

2		Aspect Ratio/Resolution (→108)
		Rec Format/[Rec Quality] (→185)
		[Quality] (→109)
		Battery capacity (→21)
	1/98	Picture number/Total pictures
	15 pic.	Number of pictures in an exposure series
	XXmXXs	Motion picture recording time *1 (→70)

3		Acquiring information icon (→272)
		Travel elapsed days (→42)
		[Silent Mode] (→162)
	11 months 30 days	Age in years/months (→166)
4		Name *2 (→165, 166)
		Location *2 (→42)
		Title *2 (→208)
5		Recording information

*1 [m] and [s] indicate "minutes" and "seconds".

*2 The displaying is performed in the following priority order: title, travel destination, name (babies and pets), and name ([Face Rec.]).

*3 With camera models 18 471 / 18 472

*4 With camera models 18 470 / 18 473

■ Detailed information display

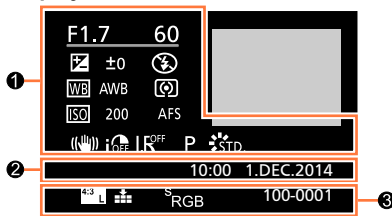

1 Recording information

i OFF	[i.Dynamic] (→111)
HDR ON	[HDR]*1 (→112)
LR OFF	[i.Resolution] (→111)
4K	4K motion picture recorded by setting [4K PHOTO] to [ON] or a still picture captured from that 4K motion picture (→192)

2 Recording date/time

World time (→41)

3

4:3 L	Aspect Ratio/Resolution (→108)
RAW	[Quality] (→109)
MP4 FHD 25p	Rec Format/[Rec Quality] (→185)
S RGB	[Color Space]*1 (→113)
100-0001	Folder/File number (→255)

■ Histogram display

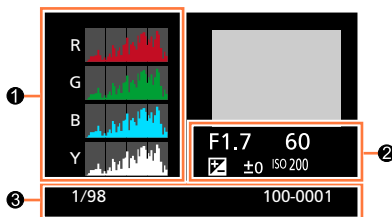

1 Histogram (→64)

2 Recording information

3

1/98	Picture number/Total pictures
100-0001	Folder/File number (→255)

*1 This is not displayed for motion pictures.

*2 With camera models 18 471 / 18 472

*3 With camera models 18 470 / 18 473

Message Displays

The following explains the meaning of major messages displayed on the monitor or viewfinder, and how to respond to them.

■ Memory cards

[Memory Card Error] [Format this card?]

- The card format cannot be used with this camera.
→ Save needed data on a computer or other device, and then use [Format] on the camera. (→26)

[Insert SD card again] [Try another card]

- Access to card has failed.
→ Insert card again.
- Try with a different card.

[Read Error] / [Write Error] [Please check the card]

- Data reading has failed.
→ Check whether card has been inserted correctly (→24)
- Data writing has failed.
→ Turn off the camera and remove the card. Reinsert the card and turn the camera on again.
- The card may possibly be damaged.
→ Try with a different card.

[Motion recording was cancelled due to the limitation of the writing speed of the card]

- The speed class of a required card varies depending on [Rec Quality] of a motion picture. Be sure to use a card of the recommended speed class. For details, refer to "About the motion picture recording and speed class" (→25).
→ If recording stops even when using a card of the recommended speed class (→25), the data writing speed has dropped. If this happens, we recommend backing up the data on the memory card and formatting it (→26).

[Memory Card Error] [This memory card cannot be used]

- The card used is not compatible with the camera. Use a compatible card.

[Cannot record due to incompatible format(NTSC/PAL) data on this card.]

- Format the card after saving necessary data on a computer etc. (→26)
→ Insert a different card.

■ Battery

[This battery cannot be used]

- Use a genuine Leica battery.
- The battery cannot be recognized as terminals are dirty.
→ Wipe any dirt from the battery terminals.

■ Wi-Fi function

[Failed to connect wireless access point] / [Connection failed] / [No destination found]

- Check the following regarding the wireless access point.
→ The wireless access point information set on the camera is wrong. Check authentication type, encryption type, and encryption key. (→242)
→ The power of the wireless access point is not turned on.
→ The setting of the wireless access point is not supported by the camera.
- Check the network setting of the destination.
- Radio transmissions from other devices may block the connection to a wireless access point.
→ Check other devices that are connected to the wireless access point and devices that use the 2.4 GHz band.

[No picture to send]

- This is displayed when there is no image to transmit due to the restriction of the destination. Check the file type of the image to transmit. (→236)

[Connection failed. Please retry in a few minutes.] / [Network disconnected. Transfer stopped.]

- Radio transmission from the wireless access point is getting weak.
→ Perform the connection closer to the wireless access point.
- There is no reply from the server or it has exceeded the communication processing time.
→ Try again after a while.
- Depending on the wireless access point, connection may be automatically disconnected after specific time has passed.
→ Reconnect the connection again.

[Connection failed]

- Check the following regarding the smartphones you intend to connect.
→ The smartphone does not operate.
→ Change the access point to connect to in the smartphone Wi-Fi settings to this camera.
→ There is no free storage space on the smartphone.

**[Some files cannot be sent because of destination limit] /
[Transfer completed. Some files are left because of destination limit.]**

- Check the file format of the image to send.
- Sending motion pictures may fail if the file size is too large. Split the motion picture using [Video Divide]. (→211)

[Cannot get IP address. Please set wireless AP's IP address setting to DHCP.]

- Turn on the DHCP settings of the IP address of the connected wireless access points.

[Cannot connect to server]

- If a message is displayed asking to update the root certificate, agree.

■ Others**[Some pictures cannot be deleted] [This picture cannot be deleted]**

- Non-DCF pictures (→67) cannot be deleted.
→ Save needed data on a computer or an other device, and then use [Format] on the camera. (→26)

[Cannot be set on this picture]

- [Print Set], [Title Edit], [Text Stamp], and other functions cannot be used for pictures that are not compliant with the DCF standard (→67).

[Please turn camera off and then on again] [System Error]

- The lens is not working correctly.
→ Turn the camera on again. (Consult your dealer or your nearest Leica Customer Care center if the display still remains.)



[A folder cannot be created]

- Folder numbers in use have reached 999.
→ Save needed data on a computer or other device, and then use [Format] on the camera (→26). Folder number is reset to 100 when performing [No.Reset] (→50).

[Picture is displayed for 16:9 TV] [Picture is displayed for 4:3 TV]

- An AV cable is connected to camera.
→ To remove the message immediately → Press [MENU/SET].
→ To change the aspect ratio → Change the [TV Aspect] setting. (→47).
- The supplied USB cable is only connected to the camera.
→ The message disappears when the cable is also connected to another device.

[Editing operation cannot proceed as information processing is ongoing.]

- If you display the playback screen when the camera contains many picture files, the acquiring information icon [] or [] may be displayed for a long time. While either one of these icons is displayed, some of the [Playback] menus cannot be used.
→ When the camera is turned off while information is being acquired, only the pictures whose information has been acquired up to that time are saved as a group. When the camera is turned on again, the camera once again begins acquiring information of the remaining pictures in the group.

Menu List

[Rec]

You can perform settings such as resolution and flash modes (for the supplied/other units).

- The [Photo Style], [AFS/AFF/AFC], [Metering Mode], [Highlight Shadow], [i.Dynamic], [i.Resolution], [i.Zoom], and [Digital Zoom] menu items are common for both [Rec] and [Motion Picture] menus. If a setting in one menu is changed, the setting with the same name in other menu will also be changed automatically.

[Photo Style]	You can select the effects according to the concept of the picture that you want to create. Adjusts the colors of effects and picture quality.	→100
[Picture Size]	Sets the number of pixels.	→108
[Quality]	Sets the compression rate.	→109
[AFS/AFF/AFC]	Selects how the focus is adjusted.	→114
[Metering Mode]	Sets the exposure metering method.	→139
[Burst Rate]	Sets the frame rate to be used for exposure series.	→142
[Auto Bracket]	Sets the Single/Continuous setting, exposure steps, and recording sequence.	→146
[Self Timer]	Sets the manner in which the self-timer works.	→148
[Highlight Shadow]	Allows you to adjust the brightness of bright and dark sections of an image while checking the results on the screen.	→102
[i.Dynamic]	Adjusts contrast and exposure.	→111
[i.Resolution]	Records still pictures with sharper outlines and the impression of high resolution.	→111
[Simultaneous record w/o filter]	Sets whether to record pictures with and those without Filter effects at the same time.	→91
[iHandheld Night Shot]	Combines nightscape pictures recorded using high-speed exposure series into a single picture.	→78
[iHDR]	When there is, for example, strong contrast between the background and the main subject, [iHDR] automatically records multiple still pictures with differing exposures and combines them to create a single still picture rich in gradation.	→79
[HDR]	The camera can combine 3 still pictures taken with different exposures into a single properly exposed picture with rich gradation.	→112
[Multi Exp.]	Allows you to create an effect similar to when exposing a single picture up to four times.	→160

Menu List

[Time Lapse Shot]	Allows you to preset the recording start time, recording interval, and the number of pictures to be taken when automatically recording time lapse motion pictures of subjects such as animals and plants.	→153
[Stop Motion Animation]	Allows you to stitch still pictures to create stop motion animation.	→156
[Panorama Direction]	Allows you to set the recording direction to be used for recording panorama pictures.	→150
[Shutter Type]	Allows you to choose between taking pictures with the mechanical or the electronic shutter.	→140
[Flash]	Sets the manner in which the flash works.	→181
[Red-Eye Removal]	Automatically detects red-eye caused by the flash and corrects the image data accordingly.	→181
[ISO Limit Set]	When the ISO sensitivity is set to [AUTO] or [ISO], an optimal ISO sensitivity is set with the selected value as an upper limit.	→137
[ISO Increments]	Changes the ISO Sensitivity settings in steps of 1/3 EV or 1 EV.	→138
[Extended ISO]	Allows you to extend the values that can be set for ISO Sensitivity.	→138
[Long Shtr NR]	Eliminates the noise caused by taking pictures at a slower shutter speed.	→113
[i.Zoom]	Allows increasing the zoom ratio with minimum image deterioration.	→173
[Digital Zoom]	Increases the focal length/zoom magnification. Note that enlarging will decrease picture quality.	→174
[Color Space]	Allows you to set the method for reproducing the colors to correctly display the recorded pictures on the screens of a computer or printer, etc.	→113
[Stabilizer]	When camera shake is sensed during recording, the camera compensates automatically.	→169
[Face Recog.]	Sets focus and exposure automatically prioritizing registered faces.	→163
[Profile Setup]	Allows you to set a name or birthday of a child or pet before taking a picture to record the name or age in months/years in the picture.	→166

[Motion Picture]

You can perform settings, such as quality, for recording motion pictures.

- The [Photo Style], [AFS/AFF/AFC], [Metering Mode], [Highlight Shadow], [i.Dynamic], [i.Resolution], [i.Zoom], and [Digital Zoom] menu items are common for both [Rec] and [Motion Picture] menus. If a setting in one menu is changed, the setting with the same name in other menu will also be changed automatically.

For details, refer to the corresponding item of the [Rec] menu.

[4K PHOTO]	Allows you to set the motion picture mode used for creating a high-resolution still picture by capturing a single frame from a 4K motion picture.	→192
[Rec Quality]	For setting the picture quality of the motion picture (resolution, frame rate, etc.) to be recorded.	→185
[Picture Mode]	For setting the recording method of still pictures to be taken while recording motion pictures.	→195
[Continuous AF]	Focusing continues whenever the targeted subject changes its distance to the camera.	→186
[Mic Level Disp.]	Allows you to set whether or not to display the microphone level on the recording screen.	→197
[Mic Level Adj.]	Allows you to adjust the audio input level in 4 steps.	→197
[Wind Cut]	If you hear wind noise during an audio recording, you can use [Wind Cut] to effectively reduce it.	→197

/c [Custom]

You can set operations, such as the screen display method and functions of a button, according to your preferences. You can also register the changed settings.

[Utilize Custom Set feature]	For calling up the setting registered using [Cust.Set Mem.].	→60
[Cust.Set Mem.]	For registering the current camera settings as a custom setting.	→60
[Silent Mode]	For disabling the beeps and flash at the same time.	→162
[AF/AE Lock]	For determining the lock setting of the focus and/or exposure used for executing AF/AE lock.	→133
[AF/AE Lock Hold]	For setting the [AF/AE] button operation used for recording by fixing focus and/or exposure.	→133
[Shutter AF]	Enables focus adjustment automatically when the shutter button is pressed halfway.	→124
[Half Press Release]	Enables shutter release when the shutter button is pressed halfway.	→124
[Quick AF]	Enables faster focusing when the shutter button is pressed.	→124
[Eye Sensor AF]	Automatically starts focusing when the eye sensor is activated.	→55
[Pinpoint AF Time]	For setting the time for displaying the enlarged screen if the shutter button is pressed halfway when Auto Focus mode is set to [+] .	→122
[Pinpoint AF Display]	For setting whether the assist screen is to be enlarged on a part of the screen or the entire screen when Auto Focus mode is set to [+] .	→122
[AF Assist Lamp]	Switches on the AF Assist Lamp when the shutter button is pressed halfway when it is too dark to facilitate focusing.	→125
[Direct Focus Area]	For moving the AF area or MF assist using the cursor buttons while recording.	→123 →131
[Focus/Release Priority]	Disables recording when a subject is out of focus.	→125
[AF+MF]	Allows manual adjustment of the focus after AF is performed.	→125
[MF Assist]	For setting the display method for MF Assist (enlarged screen).	→131
[MF Assist Display]	For setting whether the Assist screen (enlarged screen) is to be enlarged on part of the screen or over the entire screen.	→132
[MF Guide]	Displays the MF guide used to check the direction of focus on the screen when focusing is done manually.	→129

Menu List

[Peaking]	When you perform Manual Focus operation, this function automatically adds color to the sections of the image that are in focus.	→130
[Histogram]	For setting whether to display the histogram.	→64
[Guide Line]	For setting the pattern of the guidelines to be displayed while recording.	→65
[Highlight]	Flashes the overexposed areas in black and white during [Auto Review] or playback.	→72
[Zebra Pattern]	Displays areas, where overexposure may occur, using a zebra pattern.	→167
[Monochrome Live View]	Allows you to display the recording screen in black and white.	→168
[Constant Preview] (M Mode)	Allows the effects of the aperture value and shutter speed on the recording screen to be checked when [Manual Exposure] Mode is set.	→87
[Expo.Meter]	For setting whether to display the shutter speed/aperture indication.	→81
[Dial Guide]	For setting whether to display the operation guide.	→18
[EVF Disp.Style]	For setting the viewfinder display method.	→63
[Monitor Disp. Style]	For switching the monitor display method.	→62
[Monitor Info. Disp.]	For setting the recording information screen of the monitor.	→65
[Rec Area]	For setting the angle of view setting used for recording still and motion pictures.	→189
[Remaining Disp.]	Switches the display between the number of recordable pictures that you can take and the available recording time.	→28
[Auto Review]	For setting the time to display the pictures you have taken after taking still pictures.	→57
[Fn Button Set]	Allows you to assign frequently-used functions to particular buttons.	→37
[Zoom lever]	For setting the zoom lever operation setting.	→176
[Control Ring]	Allows you to assign frequently-used functions to the control ring.	→40
[Zoom Resume]	Retains the zoom position when the camera is turned off.	→176
[Q.MENU]	For setting the method for setting Quick Menu items.	→34
[A Button Switch]	Changes the operation method of the [A] button used for switching to [Snapshot Mode].	→75
[Video Button]	For enabling/disabling the motion picture button.	→189
[Eye Sensor]	For setting the sensitivity of the eye sensor or switches the display between the viewfinder and monitor.	→55

✕ [Setup]

You can perform settings for convenience of use such as the clock setting and changing of the beep sounds. You can also perform Wi-Fi function related settings.

[Clock Set]	For setting time, date, and display format.	→29
[World Time]	For setting the local time at travel destination.	→41
[Travel Date]	Allows you to set your travel schedule and record pictures, so the day of your trip on which the picture was taken will be recorded.	→42
[Wi-Fi]	For configuring the settings required for the Wi-Fi function.	→247
[Beep]	For setting the beep sounds or shutter sounds.	→43
[Live View Mode]	For setting the display speed and picture quality of the screen (Live View screen) when recording pictures.	→43
[Monitor Display]/ [Viewfinder]	For adjusting brightness and color of the monitor or viewfinder.	→44
[Monitor Luminance]	Allows you to adjust the brightness of the monitor depending on the ambient brightness.	→45
[Sleep Mode]	The camera automatically turns off if no operation is performed for a preset period of time.	→46
[USB Mode]	For selecting a communication method for when connecting the camera to a computer or printer with the supplied USB cable.	→47
[TV Connection]	Changes the settings to be used when the camera is connected to a TV or other device.	→47
[Menu Resume]	Saves the last operated menu position.	→49
[Menu Background]	For setting the background color for the menu screen.	→49
[Menu Information]	Explanations of the menu items and settings are displayed on the menu screen.	→49
[Language]	For setting the language displayed on the screen.	→49
[Version Disp.]	For checking the firmware version of the camera or supplied flash (when the flash is attached).	→50
[Self Timer Auto Off]	The self-timer is canceled if the camera is turned off.	→50
[No.Reset]	For resetting the picture file numbers.	→50
[Reset]	For resetting to the default settings.	→50
[Reset Wi-Fi Settings]	For returning [Wi-Fi] settings to default settings.	→51
[Format]	For formatting (initializes) a memory card.	→26

▶ [Playback]

You can specify picture protection, resizing, print settings, and other settings for pictures you have taken.

[Slide Show]	Automatically plays pictures in order.	→201
[Playback Mode]	Allows you to narrow down the pictures to be displayed with set filters, such as categories or favorite pictures.	→203
[Location Logging]	Allows you to write location information (longitude/latitude) sent from the smartphone to the pictures.	→204
[RAW Processing]	Allows you to use the camera to develop still pictures that were recorded in RAW format. The created still pictures are saved in JPEG format.	→205
[Title Edit]	Allows characters (comments) to be entered on a recorded picture.	→208
[Text Stamp]	Allows you to stamp the recording date and time, names, travel destination, travel dates, etc. on the recorded still pictures.	→209
[Video Divide]	A single motion picture can be split into 2 parts.	→211
[Time Lapse Video]	Allows you to create a motion picture from the pictures in a group that were recorded using [Time Lapse Shot].	→212
[Stop Motion Video]	Allows you to create a motion picture from the pictures in a group that were recorded using [Stop Motion Animation].	→212
[Resize]	For reducing a picture's resolution.	→213
[Cropping]	For enlarging your still pictures and cropping unwanted areas.	→214
[Rotate]	For manually rotating pictures by 90°.	→215
[Rotate Disp.]	For automatically rotating portrait pictures.	→215
[Favorite]	Allows you to assign a label to a picture with a mark to set it as your favorite picture.	→216
[Print Set]	For setting the pictures and the number of pictures to be printed.	→217
[Protect]	For setting protection to prevent deletion of pictures by mistake.	→218
[Face Rec Edit]	For editing or deleting the recognition information for pictures with mistaken Face Recognition.	→219
[Picture Sort]	Allows you to set the display sequence used for playing back pictures on the camera.	→220
[Delete Confirmation]	Allows you to set the Yes/No options that you want to select first on the confirmation screen when you delete a picture from either [Yes] or [No].	→220

Q&A Troubleshooting

① Try checking these items (→280 - 293) first.

If the problem persists,

② Performing [Reset] in the [Setup] menu may resolve the issue (→50). (Note that except for some items such as [Clock Set], all settings are returned to their values at the time of purchase.)

■ Battery, power

The camera does not work even if it is turned on.

- The battery is not inserted correctly (→24), or needs recharging.

The camera switches off as soon as it is turned on.

- The battery needs recharging.

The camera is turned off automatically.

- [Sleep Mode] is activated. (→46)
- If you connect to a TV compatible with HDTV Link (HDMI) with an HDMI micro cable and turn off the TV with the remote control for the TV, the camera is also turned off.
→ If you are not using HDTV Link (HDMI), set [HDTV Link] to [OFF]. (→49)

The battery discharges quickly.

- The Wi-Fi connection has been on for a long time.
→ The battery discharges faster with a Wi-Fi connection. Turn off the camera as often as possible using [Sleep Mode] (→46) or other methods.

■ Recording

I cannot record pictures.

- The card is full.
→ Free space by deleting unwanted pictures (→73).
- When a large capacity card is used, you may not be able to take a picture for a while after you turn on the camera.
- Focusing is not successful.
→ When [Focus/Release Priority] is set to [FOCUS], the camera will not record until proper focusing is achieved. (→125)

Recorded pictures look white.

- The front lens is dirty (fingerprints, etc.).
→ Turn the camera on to extend the lens barrel, and clean the lens surface with a soft, dry cloth.
- The lens is foggy (→12).

Recorded pictures are too bright/too dark.

- Adjust the exposure (→135).
- AE Lock (→133) is set to a too dark/too bright part of the subject.

Zooming stops instantaneously.

- When using the Extended Optical Zoom, the zooming action will stop temporarily. This is not a malfunction.

Some pictures are taken when I press the shutter button just once.

- The camera is set to use [Auto Bracket], White Balance Bracketing, [Aspect Bracket], or [Burst]. Self-Timer is set to [ON].
→ Clear the setting. (→106, 141)

I am unable to perform bracket recording.

- The remaining memory space in the card is low.
→ Check the remaining memory space in the card.

Focusing is not successful.

- The subject is outside of the focus range. (→126)
- This can be caused by camera shake or subject movement. (→169)
- [Focus/Release Priority] is set to [RELEASE]. (→125)
- [Shutter AF] is set to [OFF]. (→124)
- AF Lock (→133) is set inappropriately.

Recorded pictures are blurred. The stabilizer function ineffective.

- The shutter speed is slower in dark locations and the stabilizer function is less effective.
→ Hold the camera firmly with both hands, keeping your arms close to your body.
- Use a tripod and the self-timer when using a slower shutter speed (→148).

Recorded pictures appear coarse, or there is interference.

- We recommend trying the following methods.
 - Use a lower [Sensitivity] (→136).
 - Take pictures in brighter locations.
 - Either adjust [Noise Reduction] of [Photo Style] to a higher setting or set each item other than [Noise Reduction] to a lower setting. (→101)
 - Set [Long Shtr NR] to [ON]. (→113)
 - Change the settings of [Picture Size] (→108) and [Quality] (→109).
- When Digital Zoom is used, the picture quality will become lower if you zoom in higher.

Striping or flicker may appear under lighting such as fluorescent lighting and LED lighting fixtures. The subject appears distorted.

- This is characteristic of MOS sensors like the one in this camera. This is not a malfunction. If the subject moves quickly, it will appear slightly distorted.
- If you are taking still pictures using [ESHTR], the striping may be reduced by setting a slower shutter speed. (→84)

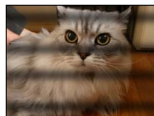
**Brightness or coloring of recorded pictures differ from reality.**

- When recording under fluorescent or LED lighting fixtures etc., increasing the shutter speed may introduce slight changes to brightness and color. These are a result of the characteristics of the light source and do not indicate a malfunction.
- When recording subjects in extremely bright locations or recording under fluorescent lighting, LED lighting fixtures, mercury lamps, sodium lighting etc., the colors and the screen brightness may change or horizontal striping may appear on the screen.

Reddish horizontal streaks appear on the screen during recording.

- This is characteristic of the MOS sensors like the one in this camera. The streaks appear when the subject has a bright part. Some unevenness may occur in the surrounding areas, but this is not a malfunction. It is recorded in motion pictures but not in still pictures.
- It is recommended that you take pictures while taking care not to expose the screen to sunlight or any other source of strong light.

Motion picture recording stops midway.

- The required speed class of a card varies depending on [Rec Quality] of a motion picture. Be sure to use a card of the recommended speed class. For details, refer to "About the motion picture recording and speed class" (→25).
- If recording stops even when using a card of the recommended speed class, the data writing speed has dropped. If this happens, we recommend backing up the data on the memory card and formatting it (→26).

The screen turns dark while recording motion pictures.

- While motion pictures are being recorded, the screen may turn dark as time passes in order to reduce battery consumption. This condition, however, will not affect the recorded motion picture.

The screen turns momentarily black or noise is recorded.

- While motion pictures are being recorded, the screen may momentarily turn black or noise may be recorded due to static electricity or strong electromagnetic fields (radio transmitters, high-voltage lines, etc.) under some environmental conditions.

Sometimes focusing with Autofocus mode is difficult while recording 4K motion pictures.

- This may occur when taking a picture by reducing the Autofocus speed in order to focus with high precision. This is not a malfunction.

Panorama picture recording stops before finishing.

- If the panning motion of the camera is too slow, the camera assumes that the operation has been aborted and stops recording.
- If the panning motion of the camera is too irregular when it is moved toward the recording direction, the camera stops recording.

The subject cannot be locked. (AF track fails)

- If the color of the subject is similar to that of its background, AF Tracking may not function. Set the AF lock to the colors specific to the subject.

Low or inaudible operating sound.

- The speaker is blocked.
- [Silent Mode] is set to [ON] (→162).

■ Monitor/viewfinder

The monitor/viewfinder is turned off although the camera is turned on.

- When a hand or an object gets close to the eye sensor, the display mode could be switched from monitor to viewfinder accidentally. (→54)

Pictures do not show on the monitor.

- Viewfinder display mode is activated.
→ Press [EVF] to switch to the monitor display mode. (→54)
- The monitor is turned off.
→ Press [DISP] to switch the display information. (→62)
- When you connect the camera to a TV using an HDMI micro cable, the picture is not displayed on the monitor/viewfinder in the following cases.
 - During playback

The displayed brightness is unstable.

- The aperture value is set while shutter button is pressed halfway. (This does not affect the recorded picture.)
This may also occur when the brightness changes because the zoom is operated or the camera is moved. This is the automatic aperture operation of the camera and is not a malfunction.

The screen flickers indoors.

- The screen may flicker for a few seconds after turning on. This is an operation to correct flicker caused by lighting such as fluorescent lights, LED lights, etc. and is not a malfunction.

The screen is too bright/too dark.

- Check the [Monitor Luminance] setting. (→45)
- Use [Monitor Display]/[Viewfinder] to adjust the brightness of the screen. (→44)

Black/blue/red/green dots or interference appears. The monitor image looks distorted when touched.

- This is not a fault, and will not be recorded on the actual pictures.

Noise appears on the monitor/viewfinder.

- In dark places, noise may appear as a result of the signal amplification necessary to maintain the brightness of the displayed image.

I cannot switch between the monitor and viewfinder when pressing [EVF].

- When connected to a computer or printer, the camera can display pictures on the monitor only.

■ Flash

I cannot perform [Flash] settings.

- The flash (supplied/optional) unit is not attached properly.
→ Properly attach it to the camera. (→177, 261)
- For details about flash settings, refer to (→177 - 184, 261).

No flash is emitted.

The flash becomes unavailable in the following cases.

- When the picture effect (Filter) is set
- When the camera is set to use [Auto Bracket], White Balance Bracket, or [Aspect Bracket]
- When using [Burst]
- During panorama picture recording
- When [HDR] is set to [ON]
- When the electronic shutter is used (→140)
→ Set [Shutter Type] to [AUTO] or [MSHTR].
- When [Silent Mode] is set to [ON] (→162)
→ Set [Silent Mode] to [OFF].

The flash fires twice.

- (Except when the [Firing Mode] of [Flash] is set to [MANUAL]) When red-eye reduction (→181) is set, the firing interval will be longer. Make sure that the subject does not move until the second flash.

■ Playback

Pictures have been rotated.

- [Rotate Disp.] is activated. (→215)

I cannot view pictures. There are no recorded pictures.

- A card is not inserted in the camera.
- There is no picture on the card to play back.
- Has the file name of the picture been changed on a computer? If so, it cannot be played back on the camera.
- [Playback Mode] is set to other than [Normal Play].
→ Set [Playback Mode] to [Normal Play]. (→203)

The folder/file number displayed as [-]. The picture is black.

- The picture was edited on computer or taken with a different device.
- The battery was removed immediately after taking the picture, or the picture was taken with an almost completely discharged battery.
→ Use [Format] to delete (→26).

Incorrect date is displayed in Calendar Search.

- The picture was edited on computer or taken with a different device.
- [Clock Set] is incorrect (→29). (An incorrect date may be displayed in Calendar Search on pictures copied to a computer and then back to the camera, if the computer and camera dates differ.)

White round spots like soap bubbles appear on the recorded picture.



- If you take a picture with flash in a dark place or indoors, white round spots may appear on the picture caused by the light from the flash reflecting particles of dust in the air. This is not a fault. A characteristic of this is that the number of round spots and their position differ in every picture.



[Thumbnail is displayed] is shown on the screen.

- The pictures may have been recorded on another device. If so, they may be displayed with poor picture quality.

Red areas in pictures appear blackened.

- When digital red-eye correction ([, []) is operating, if a subject is recorded that has skin-colored areas with red areas inside, the digital red-eye correction function may blacken the red areas.
→ We recommend setting the flash mode (for supplied/optional units) to [, or [Red-Eye Removal] to [OFF] before recording. (→181)

An unusual noise, such as a clicking or buzzing, is recorded in a motion picture. Audio is recorded at low volumes.

- When recording a motion picture in a quiet environment, noise due to the motion of the aperture and focusing mechanism may be recorded. Note that this is not a fault. You can set the focus operation during motion picture recording to [OFF] using [Continuous AF] (→186).
- Note that if you perform operations such as zooming, or use buttons or dials, operational noise may be recorded.
- If you cover the microphone with your fingers, audio may be recorded at a low volume or may not be recorded at all. In this case, the camera may pick up the lens operating sounds more easily.

Operating sounds are recorded at the end of the motion picture recording.

- Since motion pictures are recorded until the motion picture button is pressed, the operating sound level in the picture may be higher. To avoid this sound, we recommend trying the following method.
→ Cut off the end of a motion picture using [Video Divide] (→211) in the [Playback] menu. In some cases, motion pictures cannot be divided at a position close to the end. To avoid this problem, continue recording for an extra 3 seconds.

Playback and operation sounds are too low.

- The speaker is covered. (→15)

Motion pictures taken with this camera cannot be played back in other cameras.

- Even if a device is compatible with MP4, the motion pictures recorded on this camera may have bad picture quality or sound quality upon playback, or may be unable to be played back. Also, the recording information may not be displayed correctly.

■ Wi-Fi function

The camera does not connect to a wireless LAN. The transmission disconnects.

- Position the camera within the communication range of the wireless LAN network.
- Connection types and security setting methods are different depending on the wireless access point.
 - Refer to the operating instructions of the wireless access point.
- When the radio transmission is interrupted, the condition may improve by repositioning the camera or changing the angle of the wireless access point.
- When the camera is placed on a metal table or shelf, the connection may not be established easily because the camera is affected by radio transmission. Keep the camera away from metal surfaces.
- The automatic connection may not work when the network SSID of the wireless access point is set not to broadcast.
 - Set the network SSID of the wireless access point to broadcast.
- Is any device, such as microwave oven, cordless phone, etc., that uses 2.4GHz frequency operated nearby?
 - Radio transmissions may get interrupted when used simultaneously. Keep the camera sufficiently far away from such devices.
- Is the 5GHz/2.4GHz switchable wireless access point connected to other equipment using the 5GHz band?
 - The use of a wireless access point that can use 5GHz/2.4GHz simultaneously is recommended. It cannot be used simultaneously with this camera if it is not compatible.
- When the battery indicator is flashing red, the connection with other equipment may not start or the connection may be disrupted. (A message such as [Communication error] is displayed.)
- Perform [Reset Wi-Fi Settings] in the [Setup] menu.

The wireless access point is not displayed. Or it cannot be connected.

- Check if the targeted wireless access point is in operating state.
- The camera may not display or connect to a wireless access point depending on the radio transmission condition.
 - Perform the connection closer to the wireless access point.
 - Remove the obstacles between the camera and the wireless access point.
 - Change the camera's direction.
- The access point may not be displayed even if the radio transmission exists depending on the setting of the wireless access point.
 - Check the settings of the wireless access point.
- The wireless access point may not be found depending on the radio transmission condition.
 - Perform the [Manual Input]. (→242)
- Is the network SSID of the wireless access point set not to broadcast?
 - It may not be detected when it is set not to broadcast. Enter and set the network SSID. (→241)
- Connection methods differ depending on the wireless access point.
 - Refer to the operating instructions of the wireless access point.

It takes long every time to connect to a smartphone.

- It may take longer time to connect depending on the Wi-Fi connection setting of the smartphone, but it is not a malfunction.

The camera is not displayed in the Wi-Fi setting screen of the smartphone.

- Try switching the ON/OFF of the Wi-Fi function in the Wi-Fi settings of the smartphone.

I have forgotten the password for the Wi-Fi.

- Execute the [Reset Wi-Fi Settings] in the [Setup] menu. (→51)
However, the information you have set in [Wi-Fi Setup] will be reset.

I cannot connect using the NFC function.

- The smartphone is not NFC compatible.
This function can be used with NFC compatible devices with Android (2.3.3 or above).
- Is the NFC function on the smartphone turned off?
- The [NFC Operation] on the camera is set to [OFF]. (→247)
- The camera has difficulties recognizing some smartphone models. If it is not recognized, slowly move the smartphone while it is next to the camera.
- If you do not hold the smartphone close to the camera long enough, the camera may not be able to recognize it. Retain the position a bit longer.

■ TV, computer, printer

No image appears on the TV. The image is blurred or not colored.

- The connection is not correct (→249).
- The TV has not been switched to auxiliary input.
- Check the [Video Out] setting (NTSC/PAL) on the camera. (→47)
(With camera models 18 470 / 18 473)

The display on the TV and on the camera do not match.

- The aspect ratio may be incorrect or the edges may be cut off with certain TVs.

I cannot play motion pictures on the TV.

- A card is inserted into the TV.
→ Connect with an AV or an HDMI micro cable and play on the camera (→249).

The picture does not fill the TV screen.

- Check the [TV Aspect] settings (→47).

No sound is output from the camera speaker.

- When an AV or an HDMI micro cable is connected to the camera, no sound is output from the camera.

HDTV Link (HDMI) is not working.

- Is the HDMI micro cable connected correctly? (→249)
→ Check that the HDMI micro cable is fully inserted.
- Is the camera's [HDTV Link] setting set to [ON]? (→49)
→ The input setting may not be able to be changed automatically with certain TV HDMI sockets. In this case, please change the input setting with your TV's remote control (consult your TV instructions for details).
→ Check the HDTV Link (HDMI) settings on the device you are connecting to.
→ Turn the camera off and on again.
→ Provided it has this function, turn the "HDTV Link control (HDMI device control)" setting on your HDTV compatible TV to off and then to on again. (Consult your TV's instructions for details.)

The camera does not communicate with the computer.

- The connection is not correct (→254).
- Check whether the computer has recognized the camera.
→ Set the [USB Mode] to [PC] (→47).
→ Turn the camera off and then on again.

The computer does not recognize the card.

- Disconnect the USB cable connection and reconnect with the card in place.
- If there are two or more USB terminals on a single computer, try connecting the USB cable to another USB terminal.

The computer does not recognize the card. (When using an SDXC Memory Card)

- Check whether your computer is compatible with SDXC Memory Cards.
- A message prompting you to format the card may appear when you connect it. Do not format the card.
- If the [Access] indicator on the screen does not go off, turn the camera off before disconnecting the USB cable.

I cannot print when connecting to printer.

- The printer is not compatible with PictBridge.
- Set the [USB Mode] to [PictBridge(PTP)] (→47, 257).

The edges of pictures are cut off when printing.

- Delete any trimming or edgeless printing settings on the printer before printing. (Refer to the instructions for the printer.)
- The aspect ratio of pictures is different from that of paper used for printing.
 - If printing in a shop, check if 16:9 sizes can be printed.

I cannot print panorama pictures properly.

- The aspect ratio of panorama pictures is different from that of regular still pictures, and some panorama pictures may not be printed correctly.
 - Use a printer with support for panorama pictures. (Refer to the instructions for the printer.)
 - We recommend adjusting the size of a picture in accordance with the printing paper using the software available (→253).

■ Others

The menu is not displayed in the desired language.

- Change the [Language] setting (→49).

The camera rattles if shaken.

- This sound is made by the lens movement and is not a fault.

The lens makes a clicking noise.

- When the camera is turned on or off, the lens is moved, or an aperture operation is performed, such a noise may be heard. This is not a malfunction.
- When the brightness changes after a zooming operation or moving the camera, the lens may make a noise while adjusting the aperture. This is not a malfunction.

The red lamp is illuminated when pressing the shutter button halfway in dark locations.

- [AF Assist Lamp] is set to [ON] (→125).

The AF Assist Lamp is not illuminated.

- [AF Assist Lamp] is set to [OFF] (→125).
- The lamp does not light up in bright locations.

Part of a picture flashes black and white.

- [Highlight] is set to [ON]. (→72)

The camera is warm.

- The camera may become a little warm during use, but this does not affect performance or quality.

The displayed time is incorrect.

- The camera has been unused for a long period.
→ Reset the clock (→30).
- A long time was taken to set the clock (the displayed time will be behind accordingly).

The file numbers are not recorded in sequence.

- File numbers are reset when new folders are created (→50).
- If you perform this operation after performing a specific operation, the picture may be saved in a folder with a different folder number than the previous folder number.

The file numbers have jumped backwards.

- The battery was removed/inserted with the camera turned on. (Numbers may jump backwards if folder/file numbers are not correctly recorded.)

Usage Cautions and Notes

When in use

- The camera may become warm if used for long periods of time, but this is not a fault.
- **Keep the camera as far away as possible from electromagnetic equipment (such as microwave ovens, TVs, video games etc.).**
 - If you use the camera on top of or near a TV, the pictures and/or sound on the camera may be disrupted by electromagnetic fields.
 - Do not use the camera near cell phones because doing so may result in noise adversely affecting the pictures and/or sound.
 - Recorded data may be damaged, or pictures may be distorted, by strong magnetic fields created by speakers or large motors.
 - Electromagnetic fields may adversely affect the camera, disturbing the pictures and/or sound.
 - If the camera is adversely affected by electromagnetic equipment and stops functioning properly, turn it off and remove the battery. Then reinsert the battery and turn the camera on.
- **Do not use the camera near radio transmitters or high-voltage lines.**
 - If you record near radio transmitters or high-voltage lines, the recorded pictures and/or sound may be adversely affected.
- Do not extend the supplied cord or cable.
- Do not allow the camera to come into contact with pesticides or volatile substances (they can cause surface damage or the coating to peel).
- Do not keep objects that may be influenced magnetically close to the speaker.
 - Magnetized objects such as bank cards, commuter passes, watches, may be adversely affected by the magnetic influence of the speaker.
- Never leave the camera and the battery in a car in the summer. Doing so may cause leakage of the battery electrolyte, overheating, fire or a battery explosion due to the high temperature.

Caring for your camera

To clean your camera, remove the battery, and/or disconnect the power plug from the outlet, and wipe with a soft, dry cloth.

- Use a damp cloth to remove stubborn stains, before wiping with a dry cloth.
- Do not use benzine, thinners, alcohol, or kitchen detergent, as these may damage the outer casing and finish of the camera.
- If using a chemically-treated cloth, read the supplied instructions carefully.

When not using the camera for a while

- Turn off the camera before removing the battery and the card (ensure that the battery is removed to prevent damage through over-discharge).
- Do not leave the camera in contact with rubber or plastic bags.
- Store together with a drying agent (silica gel) if leaving it in a drawer, etc. Store batteries in cool places (15°C to 25°C (59°F to 77°F)) with low humidity (40% RH to 60% RH) and no major temperature changes.
- Charge the battery once per year and discharge completely before storing again.

Memory cards

- To prevent damage to cards and data
 - Avoid high temperatures, direct sunlight, electromagnetic fields, and static electricity.
 - Do not bend, drop, or expose to strong impacts.
 - Do not touch terminals on the reverse side or allow them to become dirty or wet.
- Recorded data may be damaged or lost if the camera breaks down due to inappropriate handling. Leica Camera AG will not be liable for any damage caused due to loss of recorded data.
- When disposing of/transferring memory cards
 - If using the "format" or "delete" functions on your camera or computer, this only changes the file management information, and does not completely delete the data from within the memory card. When disposing of or transferring your memory cards, we recommend physically destroying them, or using commercially available computer data erasing software to completely delete the data from the card. Data within memory cards should be handled responsibly.

Monitor/viewfinder

- Do not exert pressure on the monitor. This may cause uneven display and damage the monitor.
- In cold climates or other situations when the camera becomes cold, the monitor and/or the viewfinder may appear slightly darker than normal immediately after the camera is turned on. Normal brightness will return once the internal components have warmed up.

The monitor and viewfinder are made with extremely high precision technology. However there may be some dark or bright spots (red, blue or green) on the screen. This is not a malfunction. The monitor and viewfinder screens are controlled very thoroughly, but some pixels may be inactive. The spots will not be recorded on pictures on a card.

Battery

The battery is a rechargeable lithium ion battery.

This battery is easily affected by temperature and humidity, and is affected more when the temperature is high or low.

- The time required for charging varies depending on conditions of battery usage.
Charging takes longer at high or low temperatures and when the battery has not been used in some time.
- The battery will be warm during charging and for some time thereafter.
- The battery will discharge if not used for long periods of time, even after being charged.
- Do not leave any metal items (such as clips) near the power plug terminals.
Otherwise, a fire and/or electric shocks may be caused by short-circuiting or the resulting heat generated.
- Frequently charging the battery is not recommended.
(Frequently charging the battery reduces the maximum usage time and can cause the battery to expand.)
- If the available battery capacity is significantly reduced, it is reaching end of lifespan.
Please purchase a new battery.
- When charging:
 - Wipe dirt from the battery terminals with a dry cloth.
 - Keep at least 1m (3feet) away from an AM radio (it may cause radio interference).
- Do not use a damaged or dented battery (especially connectors), e.g. by dropping (this can cause malfunction).

Charger

- Depending on the environment while charging, the charging light may flicker due to static electricity or electromagnetic fields, etc. This has no effect on charging.
- Keep at least 1m (3feet) away from an AM radio (may cause radio interference).
- The charger may generate whirring sounds when it is being used. This is not a malfunction.
- After use, be sure to disconnect the charger from the electrical outlet. (A very small amount of current is consumed if it is left connected.)
- Keep the terminals of the charger and battery clean. When they get dirty, clean with a dry cloth.

Lens

- Images may appear slightly soft if the front lens surface is dirty (fingerprints, etc.). Turn the camera on, hold the extended lens barrel with your fingers, and gently wipe the lens surface with a soft, dry cloth.
- Do not leave the lens exposed to direct sunlight.

When using a tripod or unipod

- Do not apply excessive force or use tripods or tripod heads with damaged screws. (This may damage the camera, its tripod thread, or the label.)
- Ensure that the tripod is stable. (Refer to the tripod instructions.)
- You may not be able to remove the card or the battery when using a tripod or unipod.

Personal Information

To protect personal information, we recommend that you set a Wi-Fi password. (→247)
If names or birthdays are set in [Profile Setup] or in the [Face Recog.] function, keep in mind that the camera and recorded pictures will contain personal information.

- **Disclaimer**
 - Data containing personal information can be altered or lost due to malfunction, static electricity, accidents, breakdowns, repairs, or other operations.
Leica Camera AG will not be liable for any damage that occurs, direct or indirect, as a result of the alteration or loss of data containing personal information.
- **When ordering repairs or transferring/disposing of the camera**
 - After you make a note of the personal information, perform [Reset Wi-Fi Settings]/ [Delete account] to delete data containing personal information such as wireless LAN connection settings that you registered or set in the camera. (→51)
 - To protect your personal information, please reset the settings. (→50)
 - Remove the memory card from the camera.
 - When ordering repairs, settings may be returned to the initial purchase state.
 - If the above operations cannot be performed because of a camera malfunction, consult your dealer or the nearest Leica Customer Care department.
- **When transferring or disposing of your memory card, see “When disposing of/ transferring memory cards” in the previous section.** (→295)

Usage Cautions and Notes

- The SDXC Logo is a trademark of SD-3C, LLC.
- HDMI, the HDMI Logo, and High-Definition Multimedia Interface are trademarks or registered trademarks of HDMI Licensing LLC in the United States and other countries.
- Manufactured under license from Dolby Laboratories.
Dolby and the double-D symbol are trademarks of Dolby Laboratories.
- Leica is a registered trademark of Leica Microsystems IR GmbH.
- Summilux is a registered trademark of Leica Camera AG.
- Adobe® Photoshop® Lightroom® is a registered trademark of Adobe Systems Incorporated.
- Adobe is a trademark or registered trademark of Adobe Systems Incorporated in the United States and/or other countries.
- Pentium is a trademark of Intel Corporation in the U.S. and/or other countries.
- Windows and Windows Vista are either registered trademarks or trademarks of Microsoft Corporation in the United States and/or other countries.
- iMovie, Mac and Mac OS are trademarks of Apple Inc., registered in the U.S. and other countries.
- iPad, iPhone, and iPod touch are trademarks of Apple Inc., registered in the U.S. and other countries.
- App Store is a service mark of Apple Inc.
- Android and Google Play are trademarks or registered trademarks of Google Inc.
- The Wi-Fi CERTIFIED™ Logo is a certification mark of Wi-Fi Alliance®.
- The Wi-Fi Protected Setup™ Identifier mark is a certification mark of Wi-Fi Alliance®.
- “Wi-Fi®” and “Wi-Fi Direct®” are registered trademarks of Wi-Fi Alliance®.
- “Wi-Fi Protected Setup™”, “WPA™” and “WPA2™” are trademarks of Wi-Fi Alliance®.
- QR Code is a registered trademark of DENSO WAVE INCORPORATED.
- Other names, company names, and product names mentioned in these instructions are trademarks or registered trademarks of the companies concerned.



Usage Cautions and Notes

This product is licensed under the AVC patent portfolio license for the personal and non-commercial use of a consumer to (i) encode video in compliance with the AVC Standard ("AVC Video") and/or (ii) decode AVC Video that was encoded by a consumer engaged in a personal and non-commercial activity and/or was obtained from a video provider licensed to provide AVC Video. No license is granted or shall be implied for any other use. Additional information may be obtained from MPEG LA, LLC.
See <http://www.mpegla.com>.

This product incorporates the following software:

- (1) the software owned by third party and licensed to Leica Camera AG, and/or
- (2) open source software

The software categorized as (2) is distributed in the hope that it will be useful, but WITHOUT ANY WARRANTY, without even the implied warranty of MERCHANTABILITY or FITNESS FOR A PARTICULAR PURPOSE. Please refer to the detailed terms and conditions thereof displayed by selecting [MENU/SET] → [Setup] → [Version Disp.] → [Software info].

Leica Service Addresses

Leica Product Support

The Leica Product Support department can provide you with an answer to any technical questions relating to Leica products, including software supplied, either in writing, on the telephone or by e-mail.

It is also the contact point for purchasing advice and to order instructions.

Alternatively, you can send us your questions using the contact form on the Leica Camera AG homepage.

Leica Camera AG

Product Support / Software Support

Am Leitz-Park 5

D-35578 Wetzlar

Telephone: +49 (0) 6441-2080-111 /-108

Fax: +49 (0) 6441-2080-490

info@leica-camera.com / software-support@leica-camera.com

Leica Customer Care

For servicing your Leica equipment or in the event of damage, the Leica Camera AG Customer Care department or the repair service provided by authorized Leica agents in your country are available (for addresses, see Guarantee Card).

Leica Camera AG

Customer Care

Am Leitz-Park 5

D-35578 Wetzlar

Telephone: +49 (0) 6441-2080-189

Fax: +49 (0) 6441-2080-339

customer.care@leica-camera.com



my point of view