



LEICA V-LUX 4

Instructions

About
downloading
Adobe® Photoshop®
Lightroom®
see page 50.

Table of Contents

Before Use

Care of the camera	6
Scope of Delivery / Accessories	7
Names and Functions of the Components	8

Preparation

Attaching the Lens Cap/the Shoulder Strap	13
Attaching the Lens Hood	14
Charging the Battery	15
• Charging	15
• Operating time and number of recordable pictures	17
Inserting and Removing Card and Battery	19
About the Internal Memory/the Card	20
• Number of recordable pictures and available recording time	22
Setting Date/Time	24
• Changing the clock setting	25
Tips for taking good pictures	26
• Preventing camera shake	26

Basic

Selecting the Recording Mode	27
Program Mode	28
• Program Shift	29
Focusing	30
Snapshot Mode	32
• Using the Defocus Control Function	34
• Changing the menu settings	35
• Recording using Snapshot Plus Mode	36
Recording Motion Pictures	38
• Recording still pictures while recording motion pictures	41
Playing Back Pictures	42
• Selecting a picture	42
• Displaying Multiple Images	43
• Using the Playback Zoom	43
Playing Back Motion Pictures	44
• Creating Still Pictures from a Motion Picture	45
Deleting Pictures	46
• Deleting a single picture	46
• Deleting multiple pictures (up to 100) or all the pictures	47
Setting the Menu	48
• Setting menu items	49
• Using the Quick Menu	51
About the Setup Menu	52

Recording

About the Monitor/the Viewfinder	66
Using the Zoom	68
• Using the Optical Zoom/the Extended Optical Zoom (EZ)/the Intelligent Zoom/ the Digital Zoom	68
Using the Built-In Flash	72
• Switching flash modes	73
Exposure Compensation	76
Continuous Mode	77
Using the Self-Timer	80
Setting the Sensitivity	82
Setting the White Balance	84
Using Auto Focus	88
Close-up Pictures	92
Manual Focusing	93
Focus and Exposure Memory Lock (AF/AE Lock)	96
Using the function button	98
Aperture-Priority Mode	99
Shutter-Priority Mode	100
Manual Exposure Mode	101
Using the Scene Modes	102
• [Portrait]	102
• [Soft Skin]	103
• [Scenery]	103
• [Panorama Shot]	104
• [Sports]	106
• [Panning]	106
• [Night Portrait]	107
• [Night Scenery]	107
• [Handheld Night Shot]	108
• [HDR]	108
• [Food]	108
• [Baby1]/[Baby2]	109
• [Pet]	110
• [Sunset]	110
• [High Sens.]	110
• [Glass Through]	110
• [3D Photo Mode]	111
Using the different image effects	112
• [Expressive]	113
• [Retro]	113
• [High Key]	113
• [Low Key]	113
• [Sepia]	114
• [Dynamic Monochrome]	114
• [Impressive Art]	114
• [High Dynamic]	114

• [Cross Process]	115
• [Toy Effect]	115
• [Miniature Effect]	115
• [Soft Focus]	117
• [Star Filter]	117
• [One Point Color]	117
Recording Motion Pictures with Manual Settings	118
• Recording High Speed Motion Pictures	119
Using Custom Mode	120
• Registering Personal Menu Settings	121
• Recording using registered custom settings	121
Using the Face Recognition Function	122
• Face Settings	123
Entering Text	126
Using the [Rec] menu	127
• [Photo Style]	127
• [Aspect Ratio]	128
• Resolution [Picture Size]	129
• [Quality]	130
• [ISO Limit Set]	131
• [ISO Increments]	131
• [Extended ISO]	131
• [Face Recog.]	131
• [AF Mode]	131
• [AF Style]	132
• [Quick AF]	133
• [AF/AE Lock]	133
• [Metering Mode]	133
• [i. Dynamic] (Intelligent dynamic range control)	134
• [Min. Shtr Speed]	134
• [i. Resolution]	135
• [Digital Zoom]	135
• [Stabilizer]	136
• [AF Assist Lamp]	137
• [Flash]	137
• [Flash Synchro]	137
• [Flash Adjust.]	138
• [Red-Eye Removal]	138
• [Auto Bracket]	139
• [Date Stamp]	140
• [Clock Set]	140
Using the [Motion Picture] menu	141
• [Rec Mode]	141
• [Rec Quality]	142
• [High Speed Video]	143
• [Continuous AF]	143
• [Wind Cut]	144

• [Zoom Mic].....	144
-------------------	-----

Playback/Editing

Having Fun with Recorded Pictures	145
• [Auto Retouch].....	145
• [Creative Retouch].....	146
Playing Back Picture Series	147
Editing Picture Series	148
Various playback methods	149
• [Slide Show].....	149
• [Filtering Play].....	152
• [Calendar].....	153
Using the [Playback] menu	154
• [Title Edit].....	154
• [Text Stamp].....	155
• [Video Divide].....	157
• [Resize].....	158
• [Cropping].....	159
• [Leveling].....	160
• [Favorite].....	161
• [Print Set].....	162
• [Protect].....	164
• [Face Rec Edit].....	165
• [Copy].....	166

Connecting to other equipment

Playing Back Pictures on a TV	167
• Using HDTV Link.....	169
Playing back 3D pictures	171
Saving still and motion pictures on your computer	173
Saving still and motion pictures on a Recorder	177
Printing the Pictures	178
• Selecting a single picture and printing it.....	179
• Selecting multiple pictures and printing them.....	179
• Print Settings.....	180

Others

Screen Displays	183
Cautions for Use	186
Message Displays	190
Troubleshooting	193
Leica Service Addresses	203

Care of the camera

Do not subject the camera to strong vibration, shock, or pressure.

- The lens, monitor, or external body parts may be damaged by such treatment.

It may also malfunction or the image may not be recorded.

– Do not drop or hit the camera.

– Do not exert excessive pressure on the lens barrel or the monitor.

- **When the camera is not in use or when using the playback feature, ensure that the lens is in the retracted position, with the lens cap attached.**

- **During certain operations, the camera may emit rattling sounds or vibrations. These are due to the motorized diaphragm and lens zoom setting and do not indicate a defect.**

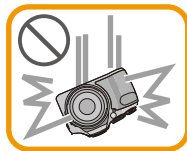

This camera is not dust/splash/waterproof.

Avoid using the camera at locations with a lot of dust, water, sand, etc.

- Liquids, sand and other foreign material may enter the camera through the gaps around the lens barrel, the buttons, etc. Be particularly careful since it may not just cause malfunctions, but it may become unreparable.

– Take special care in places with a lot of sand or dust.

– Take special care in places where water can come into contact with the camera such as when using it on a rainy day or on the beach.

■ About Condensation (When the lens or viewfinder is fogged up)

- Condensation occurs when the equipment is subjected to significant changes of the ambient temperature or humidity. Try to avoid condensation since it causes lens stains, fungus and camera malfunction.

- If condensation occurs, turn the camera off and leave it for about 2 hours.

The fog will disappear naturally when the temperature of the camera approaches the ambient temperature.



Scope of Delivery / Accessories

■ Scope of Delivery

	Order No.
Rechargeable battery BP-DC12-E BP-DC12-U	18 728 18 729
Battery charger BC-DC12-E BC-DC12-U	423-111.001-012 423-111.002-010
Mains cable EU UK AUS TW CN KR	423-111.001-006 423-111.001-007 423-068.801-023 423-111.001-009 423-111.001-010 423-111.001-008 (delivery differs depending on markets)
Shoulder strap	423-094.001-014
Lens hood	423-111.001-015
Lens cap w. string	423-111.001-018
CD with instr. PDFs	423-111.001-016
USB cable	423-106.001-010
AV cable	423-105.001-010
Button template for Canada / Taiwan	423-111.001-025/-026 (only with camera model 18 191 / 18 192)
Short instructions	93 483 -486 (delivery differs depending on markets)
Warranty Card	439-399.100-026

■ Accessories

	Order No.
Small system case	18 746
Leica CF 22 flash unit	18 694
HDMI mini cable	14 491
Tabletop tripod	14 100
Ball and socket head	14 110

Notes:

- Cards are optional. You can record or play back pictures on the internal memory when you are not using a card.
- Check that all items belonging to the scope of delivery are included before using the camera.
- The items and their shape may differ depending on the country or area where the camera was purchased.
- Keep small parts in a safe place out of the reach of children.
- Please dispose of all packaging appropriately.

Names and Functions of the Components

- 1 Lens (P6, 187)
- 2 Zoom lever (P68)
- 3 Shutter release button (P28, 32)
- 4 Self-timer indicator (P80)/
AF Assist Lamp (P137)
- 5 Mode dial (P27)
- 6 Flash (P72)
- 7 Flash release slider (P72)
- 8 Shoulder strap eyelet (P13)
- 9 Focus selector switch (P92, 93)
- 10 Zoom/focus rocker (P69, 94)
- 11 [FOCUS] button (P32, 91, 95)
- 12 Lens barrel

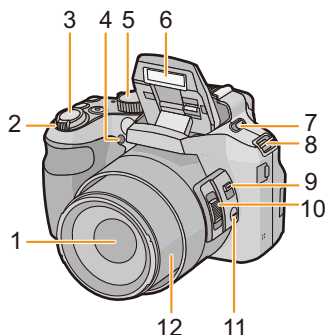

- 13 Monitor (P66, 183)
- 14 Viewfinder (P11, 183)
- 15 [EVF/LCD] button (P11)
- 16 Hot shoe
- 17 Stereo microphone
- 18 [▶] (Playback) button (P42)
- 19 [AF/AE LOCK] button (P96)/[Fn2] button (P98)
- 20 Camera ON/OFF switch (P24)
- 21 Motion picture button (P38)
- 22 [⏻] (Continuous Mode) button (P77)
- 23 [Fn1] button (P98)
- 24 Power lamp (P24)
- 25 Setting wheel (P12)
- 26 [DISP.] button (P66)
- 27 [MENU/SET] button (P12, 49)
- 28 [Q.MENU] button (P51)/[⏏/↵] (Delete/Cancel) button (P46)
- 29 Cursor buttons (P12)

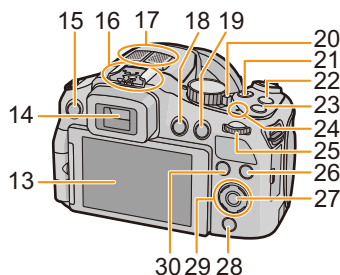

- ① ▲/ ISO (P82)
 - ② ▼/ Self-timer (P80)
 - ③ ◀/ AF MODE (P88)
 - ④ ▶/ (WB) White Balance (P84)
- 30 [Fn3] button (P98)

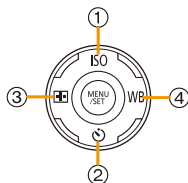

-
- 31 Diopter adjustment dial (P11)
32 [MIC/REMOTE] socket
33 Speaker (P54)
- Be careful not to cover the speaker with your finger. Doing so may make sound difficult to hear.

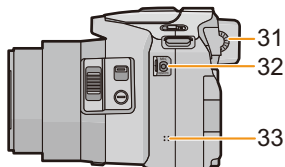

-
- 34 [HDMI] socket (P167)
35 [AV OUT/DIGITAL] socket (P167, 174, 177, 178)

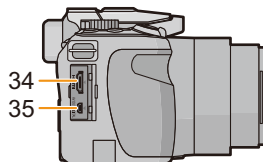

-
- 36 Tripod thread (P189)
- Using tripods with screw lengths of 5.5mm (7/32") or more may damage the camera if attached.
- 37 Release slider (P19)
38 Card/Battery door (P19)

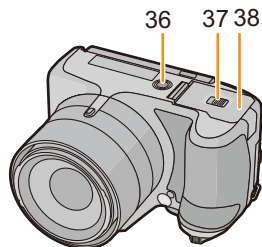

Monitor

At the time when this camera is purchased, the monitor faces the camera body. Fold out the monitor as shown below.

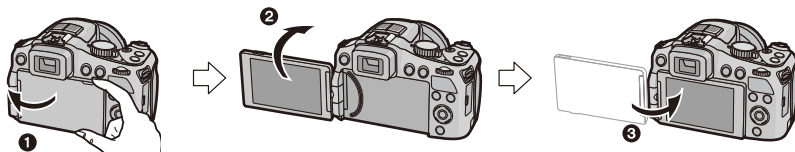

❶ Fold out the monitor. (Maximum 180°)

❷ It can be rotated 180° forwards.

❸ Return the monitor to its original position.

• **Only rotate the monitor after opening it wide enough, and be careful not to use excessive force as this may damage it.**

• Do not cover the AF Assist Lamp with your fingers or other objects.

■ Taking pictures at a high angle

• This is convenient when there is someone/something between you and your subject.



• It can only be rotated 90° towards you.

■ Taking pictures at a low angle

• This is convenient when taking pictures of flowers etc. that are in a low position.

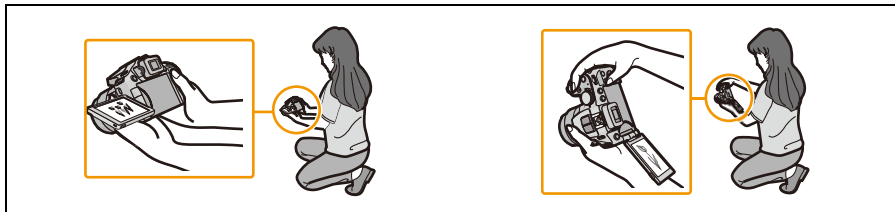

• It can be rotated 180° forwards.

Notes

- Be careful as the camera may get scratched if you rotate the monitor without folding it out completely.
- When not using the monitor it is recommended that you close it with the screen facing inwards to prevent dirt and scratches.
- Note that operating noise may be recorded when rotating the monitor while recording a motion picture.

Viewfinder

Switching between the monitor/the viewfinder

Press [EVF/LCD].

- Switching via the [EVF/LCD] button will be maintained even when the camera is turned off.

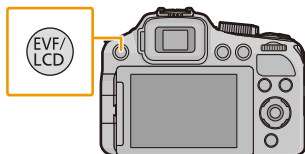

Diopter adjustment

Look at the viewfinder image and rotate the diopter adjustment dial so that you can see the image and the displays clearly.

- (A) Diopter adjustment dial

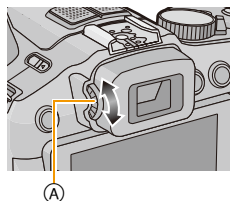

Cursor buttons/[MENU/SET] button

Cursor button:

For selection of items or setting of values etc.

[MENU/SET] button:

For confirmation of settings, etc.

- This document mentions the top, bottom, left, and right sections of the cursor button as follows, or as ▲/▼/◀/▶.

e.g.: When you press the ▼ (down) section

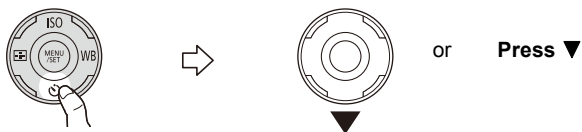

Setting wheel

There are 2 ways to operate the setting wheel, rotating it to the left or the right, or by pressing it.

Rotating:

For selection of items or setting of values.

Pressing:

For confirmation of settings, i.e. operations that are the same as [MENU/SET] button.

- Setting wheel operation is indicated as follows in these instructions:

e.g.: Rotate to the left or to the right

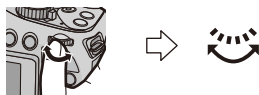

e.g.: Press



Attaching the Lens Cap/the Shoulder Strap

■ Attaching the Lens Cap

- When the camera is not being used, always attach the lens cap to protect the lens.

- 1 Pass the string through the strap eyelet on the camera.

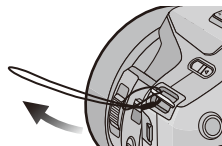

- 2 Pass the same string through the eyelet on the lens cap.

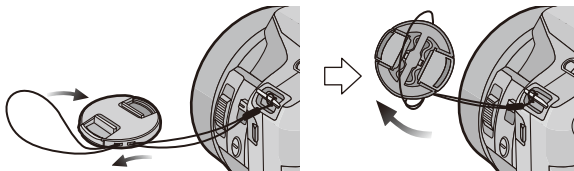

- 3 Attach the lens cap.

- Do not hang or swing around the camera holding it only by the lens cap string.
- Make sure to remove the lens cap before turning the camera on.
- Take care not to entangle the lens cap string with the shoulder strap.

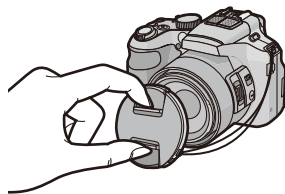

■ Attaching the Shoulder Strap

- We recommend attaching the shoulder strap when using the camera to prevent it from dropping.

- 1 Pass one end of the shoulder strap through the shoulder strap eyelet.



- 2 Pass the shoulder strap through the stopper and pull the shoulder strap tight.

- (A) Let the end of the strap extend 2cm ($\frac{25}{32}$ "") or more.

- Attach the shoulder strap to the other side of the camera without twisting it.

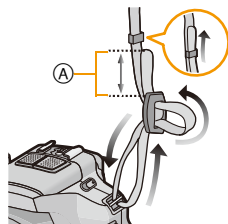

Attaching the Lens Hood

In bright sunlight or backlight, the lens hood will minimize lens flare and ghosting. The lens hood cuts off excess lighting and improves the picture quality and should therefore remain mounted for most photographing situations (exemptions: see below).

- Check that the camera is turned off.
- Close the flash.

1 Attach the lens hood on the lens with one of the short petals aligned with the bottom of the camera.

- Do not exert excess pressure to any part of the lens hood.

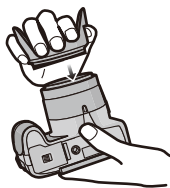

2 Rotate the lens hood in the direction of the arrow.



3 Rotate the lens hood as far as it will go, i.e. overcoming the increased resistance just before the final position and until the two marks on the hood and the camera body (A) are aligned. (The lens hood will “click” into place.)

- Check that the lens hood is firmly attached and that it does not appear in the picture.

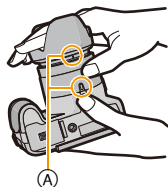

Notes

- When taking pictures with flash and the lens hood attached, the lower portion of the pictures may be dark (vignetting effect) and the control of the flash may be disabled because it may be obscured by the lens hood. We recommend to remove it for flash photography.
- When the lens hood is to be removed temporarily, attach it to the lens in the reverse direction.

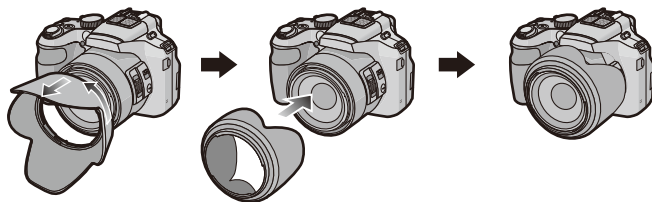

Charging the Battery

About batteries that you can use with this camera

It has been found that counterfeit batteries which look very similar to the genuine product are made available to purchase in some markets. Some of these batteries are not adequately protected with internal protection to meet the requirements of appropriate safety standards. There is a possibility that these batteries may lead to fire or explosion. Please be advised that Leica Camera AG is not liable for any accident or failure occurring as a result of use of a counterfeit battery. To ensure that safe products are used we urgently recommend to use only the Leica battery BP-DC12 (P7).

- Use only the dedicated charger and battery.

Charging

- The battery is not charged when the camera is shipped. Charge the battery before use.
- Charge the battery indoors.
- Charge the battery in areas with an ambient temperature between 10°C and 30°C (50°F and 86°F) (same as the battery temperature).

1 Insert the battery into the charger.

- The terminals should face the charger's contacts and the Leica logo upwards.

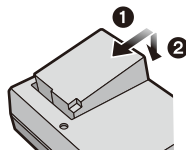

2 Connect the charger to the electrical outlet.

- The [CHARGE] indicator (A) lights up and charging begins.

Plug-in type

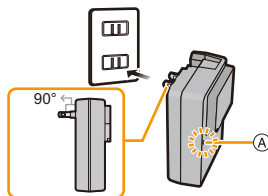

Cable type

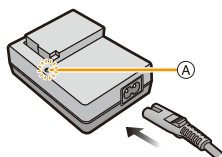

■ About the [CHARGE] indicator

The [CHARGE] indicator turns on:

Charging has started.

The [CHARGE] indicator turns off:

Charging has been completed without any problem. (Disconnect the charger from the electrical outlet and detach the battery after charging is completed.)

• When the [CHARGE] indicator flashes

- The battery temperature is too high or too low. It is recommended to charge the battery again in an ambient temperature of between 10°C and 30°C (50°F and 86°F).
- The terminals of the charger or the battery are dirty. In this case, wipe them clean with a dry cloth.

■ Charging time: approx. 140 min

- The indicated charging time is for when the battery has been discharged completely. The charging time may vary depending on how the battery has been used. The charging time for the battery in hot/cold environments or a battery that has not been used for long time may be longer than normal.

■ Battery indication

The battery indication is displayed on the monitor/viewfinder.



- The indication turns red and flashes if the remaining battery power is exhausted. (The power lamp also flashes) Recharge the battery or replace it with a fully charged battery.

📌 Notes

- **Do not leave any metal items (such as clips) near the power plug terminals. Otherwise, a fire and/or electric shocks may be caused by short-circuiting or the resulting generated heat.**
- The battery becomes warm during use and during and after charging. The camera also becomes warm during use. This is not a malfunction.
- The battery can be recharged even when it still has some charge left, but it is not recommended that the battery charge be frequently topped up while the battery is fully charged. (Since characteristic swelling may occur.)

Operating time and number of recordable pictures

■ Recording still pictures (When using the monitor)

Number of recordable pictures	approx. 540 pictures	(By CIPA standard in Program Mode)
Recording time	approx. 270 min	

Recording conditions by CIPA standard

- CIPA is an abbreviation of [Camera & Imaging Products Association].
- Temperature: 23°C (73.4°F)/Humidity: 50% RH when the monitor is on.
- Using a 32MB SD Memory Card.
- Using the supplied battery.
- Starting recording 30 seconds after the camera is turned on. (When the Optical Image Stabilizer function is set to [ON].)
- **Recording once every 30 seconds** with full flash every second recording.
- Rotating the zoom lever from Tele to Wide or vice versa in every recording.
- Turning the camera off every 10 recordings and leaving it until the battery has cooled down again.

The number of recordable pictures varies depending on the recording interval time. If the recording interval time becomes longer, the number of recordable pictures decreases. (For example, if you were to take one picture every two minutes, then the number of pictures would be reduced to approximately one-quarter of the number of pictures given above.)

■ Recording motion pictures (When using the monitor)

	[AVCHD] (Recording with resolution set to [PSH])	[MP4] (Recording with resolution set to [FHD])
Recordable time	approx. 160 min	approx. 200 min
Actual recordable time	approx. 80 min	approx. 100 min

- These times are for an ambient temperature of 23°C (73.4°F) and a humidity of 50% RH. Please be aware that these are approximate times.
- Actual recordable time is the time available for recording when repeating actions such as turning the camera on and off, starting/stopping recording, zoom operation etc.
- **With camera model 18 190:**
Maximum time to record motion pictures continuously with [AVCHD] is 29 minutes.
Maximum time to record motion pictures continuously with [MP4] is 29 minutes or up to 4GB.
You can check the recordable time on the screen. (For [FHD] in [MP4] format, the file size is large and so the recordable time will drop below 29 minutes.)
- **With camera models 18 191 / 18 192:**
Maximum time to record motion pictures continuously with [MP4] is 29 minutes or up to 4GB.
You can check the recordable time on the screen. (For [FHD] in [MP4] format, the file size is large and so the recordable time will drop below 29 minutes.)

■ Playback (When using the monitor)

Playback time	approx. 440 min
----------------------	-----------------

Notes

- **The operating times and number of recordable pictures will differ according to the environment and the operating conditions.**
For example, in the following cases, the operating times will be shorter and the number of recordable pictures is reduced.
 - In low-temperature environments, such as on ski slopes.
 - When using [LCD Mode].
 - When [Live View Mode] is set to [NORMAL].
 - When operations such as flash and zoom are used repeatedly.
- When the operating time of the camera becomes extremely short even after properly charging the battery, the life of the battery may have expired. Buy a new battery.

Inserting and Removing Card and Battery

- Turn the camera off and confirm that the lens barrel is retracted.
- Close the flash.

1 Set the camera ON/OFF switch to OFF, push the release slider in the direction of the arrow, and open the card/battery door.

- Use only the Leica battery BP-DC12 (P7).
- We cannot guarantee the quality of any other batteries.

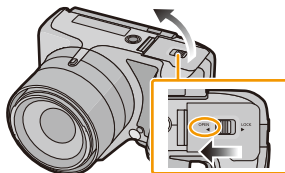

2 Insert battery and card.

Be sure to insert in the correct orientation.

Battery: Push it in until it is locked by the lever (A). To remove, pull this lever in the direction of the arrow.

Card: Push it down until it clicks into place. To remove, push it further down until it clicks, then pull it out upright.

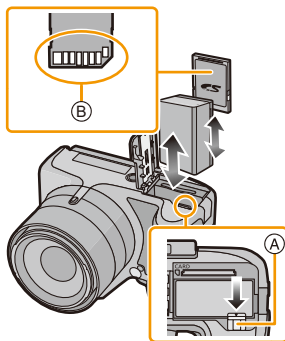

(B): Do not touch the connection terminals of the card.

3 **1:** Close the card/battery door.

2: Push the release slider in the direction of the arrow.

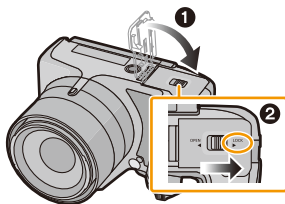

Notes

- Remove the battery when you are not going to use the camera for a long time. (The battery will be exhausted if left for a long period of time after being charged.)
- Remove the card or battery only after turning off the power, i.e. with the power lamp completely turned off and the lens barrel retracted completely. (Otherwise, the camera may not function properly, or the card or the recorded contents may be damaged.)

About the Internal Memory/the Card

The camera stores the image data as follows.

When no card is inserted	Pictures are recorded and played back in/ from the internal memory.
When a card is inserted	Pictures are recorded and played back on/ from the card.

• When using the internal memory

 (access indication*)

• When using the card

 (access indication*)

- * The access indication is displayed in red when pictures are being recorded on the internal memory (or the card).



Internal Memory

- You can copy the recorded pictures to a card. (P166)
- The access time for the internal memory may be longer than the access time for a card.

Memory size	approx. 70MB
-------------	--------------

Card

The following cards which conform to the SD video standard can be used with the camera.

	Remarks
SD memory cards (8MB to 2GB)	<ul style="list-style-type: none"> • Use a card with SD Speed Class* with “Class 4” or higher when recording motion pictures.
SDHC memory cards (4GB to 32GB)	<ul style="list-style-type: none"> • SDHC type memory cards can be used with SDHC or SDXC memory card compatible equipment. • SDXC type memory cards can only be used with SDXC memory card compatible equipment.
SDXC memory cards (48GB to 64GB)	<ul style="list-style-type: none"> • Check that the computer and other equipment are compatible when using SDXC type memory cards. • The camera is compatible with UHS-I standard SDHC/SDXC memory cards. • Only cards with the capacities listed on the left can be used.

* SD Speed Class is the speed standard regarding continuous writing. Check via the label on the card, etc.

e.g.:

CLASS 



Notes

- **Do not turn the camera off, remove its battery or card when the access indication is lit (when pictures are being written, read or deleted, or the internal memory or the card is being formatted). Furthermore, do not subject the camera to vibration, impact or static electricity. The card or the data on the card may be damaged, and the camera may no longer operate normally.**

If operation fails due to vibration, impact or static electricity, perform the operation again.

- Write-Protect switch : When this switch is set to the [LOCK] position, no further data writing, deletion or formatting is possible. The ability to write, delete and format data is restored when the switch is returned to its original position.
- The data in the internal memory or on the card may be damaged or lost due to electromagnetic fields, static electricity or breakdown of the camera or the card. We recommend storing important data on a computer etc.
- Do not format the card on your computer or other equipment. Format it on the camera only to ensure proper operation. [\(P65\)](#)
- Keep memory cards out of reach of children to prevent swallowing.



Number of recordable pictures and available recording time

About the display of the number of recordable pictures and available recording time

- Switching between the display of number of recordable pictures and available recording time can be performed in the [Remaining Disp.] (P58) in the [Setup] menu.

(A) Number of recordable pictures

(B) Available recording time



- The number of recordable pictures and the available recording time are an approximation. (These vary depending on the recording conditions and the type of card.)
- The number of recordable pictures and the available recording time varies depending on the subjects.

Number of recordable pictures

- [+99999] is displayed if there are more than 100,000 pictures remaining.

• Aspect ratio [4:3], Quality [S]

[Picture Size]	Internal Memory (approx. 70MB)	2GB	32GB	64GB
12M	13	380	6260	12670
5M (EZ)	24	650	10620	21490
0.3M (EZ)	380	10050	162960	247150

■ Available recording time (when recording motion pictures)

• “h” is an abbreviation for hour, “m” for minute and “s” for second.

• [AVCHD]

[Rec Quality]	Internal Memory (approx. 70MB)	2GB	32GB	64GB
PSH	–	8m00s	2h31m00s	5h07m00s
FSH	–	14m00s	4h10m00s	8h26m00s
SH	–	14m00s	4h10m00s	8h26m00s

• [MP4]

[Rec Quality]	Internal Memory (approx. 70MB)	2GB	32GB	64GB
FHD	–	12m02s	3h22m58s	6h50m54s
HD	–	22m59s	6h27m29s	13h04m28s
VGA	1m42s	50m36s	14h12m48s	28h46m30s

Notes

• The recordable time is the total time of all the motion pictures which have been recorded.

• With camera model 18 190:

Maximum time to record motion pictures continuously with [AVCHD] is 29 minutes.

Maximum time to record motion pictures continuously with [MP4] is 29 minutes or up to 4GB.

You can check the recordable time on the screen. (For [FHD] in [MP4] format, the file size is large and so the recordable time will drop below 29 minutes.)

• With camera models 18 191 / 18 192:

Maximum time to record motion pictures continuously with [MP4] is 29 minutes or up to 4GB.

You can check the recordable time on the screen. (For [FHD] in [MP4] format, the file size is large and so the recordable time will drop below 29 minutes.)

• The maximum available continuous recording time is displayed on the screen.

Setting Date/Time (Clock Set)

- The clock is not set when the camera is shipped.

1 Turn the camera on.

- The power lamp ❶ lights when you turn the camera on.
- If the language select screen is not displayed, proceed to step 4.

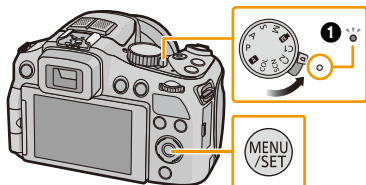

2 Press [MENU/SET].

3 Press ▲/▼ to select the language, and then [MENU/SET].

4 Press [MENU/SET].

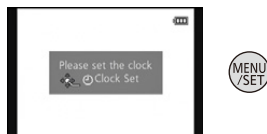

5 Press ◀/▶ to select the items (year, month, day, hour, minute, display sequence or time display format), and then ▲/▼ to set.

- Ⓐ: Time at the home area
- Ⓑ: Time at the travel destination

- You can cancel without setting the clock by pressing [⏏/⏪].

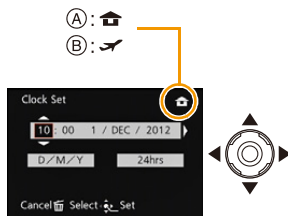

6 Press [MENU/SET] to set.

7 Press [MENU/SET].

Changing the clock setting

Select **[Clock Set]** in the **[Rec]** or **[Setup]** menu, and press ►. (P49)

- The clock can be reset as shown in steps **5** and **6**.
- **The clock setting is maintained for 3 months using the built-in back-up battery even without the main battery inserted. (Leave the charged battery in the camera for 24 hours to charge the back-up battery.)**

Notes

- If the clock is not set, the correct date cannot be printed when you order a store/lab to print the picture, or when you stamp the date on the pictures with **[Date Stamp]** (P140) or **[Text Stamp]** (P155).
- If the clock is set, the correct date can be printed even if the date is not displayed on the monitor/viewfinder.

Tips for taking good pictures

Hold the camera firmly with both hands, keep your arms still at your side and stand with your feet slightly apart.

- Be careful not to place your fingers on the flash, AF Assist Lamp (A), microphone (B), speaker or lens etc.
- Be careful not to cover the speaker with your finger. Doing so may make sound difficult to hear. (P9)
- Hold the camera as still as possible when you release the shutter, i.e. when you press the shutter release button.
- When taking pictures, make sure your footing is stable and there is no danger of colliding with another person, an object etc.
- Do not hold the lens barrel as you take pictures. There is a risk that your fingers may be pinched as the lens retracts.

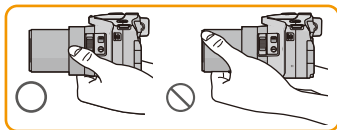

■ Direction Detection Function ([Rotate Disp.]

Pictures recorded with the camera held vertically are played back vertically (rotated). (Only when [Rotate Disp.] (P64) is set)

- When the camera is held vertically and tilted up and down to record pictures, the Direction Detection function may not work correctly.
- Motion pictures taken with the camera held vertically are not displayed vertically.
- You cannot record 3D pictures in vertical orientation.

Preventing camera shake

When the camera shake alert [ⓘ] appears, use [Stabilizer] (P136), a tripod or the Self-timer (P80).

- The shutter speed will be slower particularly in the following cases. Keep the camera still from the moment the shutter release button is pressed until the picture appears on the monitor/viewfinder. We recommend using a tripod.
 - Slow sync./Red-Eye Reduction
 - [Night Portrait]/[Night Scenery] (Scene Mode)
 - When a slow shutter speed limit has been set in [Min. Shtr Speed]

Selecting the Recording Mode

Change modes by rotating the mode dial.

Align the desired mode with index **A**.

- Make sure the dial is set exactly to the click-stop position of the desired mode. (The mode dial rotates 360°)

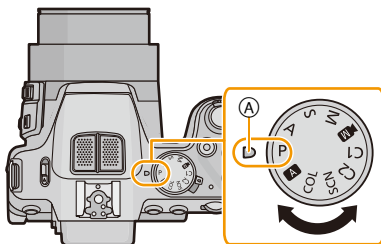

■ Basic

P	Program Mode (P28)
For taking pictures with automatic exposure control.	
A	Snapshot Mode (P32)
For taking pictures with extended automatic settings.	

■ Advanced

A	Aperture-Priority Mode (P99)
The exposure is determined by the automatically controlled shutter speed, based on the manually set aperture value.	
S	Shutter-Priority Mode (P100)
The exposure is determined by the automatically controlled aperture value, based on the manually set shutter speed.	
M	Manual Exposure Mode (P101)
The exposure is determined by the manually set aperture value and shutter speed.	
M	Creative Video Mode (P118)
For recording motion pictures with manual settings.	
C1 C2	Custom Mode (P120)
Use this mode to take pictures with previously registered settings.	
SCN	Scene Mode (P102)
For taking pictures with preset menu settings that match the scene being recorded.	
COL	Creative Control Mode (P112)
For recording while checking the image effect.	

Program Mode

Recording mode: [A] [P] A S M [M] C1 C2 SCN COL

The camera automatically sets the shutter speed and the aperture value according to the brightness of the subject.

You can also change various settings in the [Rec] menu.

1 Set the mode dial to [P].

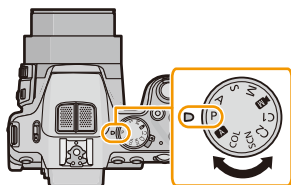

2 Aim the AF frame at the subject you want to focus on.

3 Press the shutter release button halfway to focus.

- (A) Aperture value
- (B) Shutter speed
- (C) ISO sensitivity

- The focus indication (D) (green) lights up when the subject is focused.
- The maximum close-up distance (the shortest distance at which the subject can be taken) differs depending on the set focal length. Please check with the focus range display. (P31)
- Aperture value and shutter speed are displayed in red when a correct exposure cannot be achieved. (Except when using a flash)

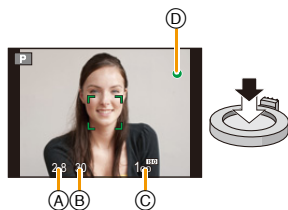

4 Press the shutter release button fully (push it in further), and take the picture.



Program Shift

In Program Mode, you can change the preset aperture value and shutter speed combinations without changing the exposure. This is called program shift.

You can e.g. reduce the extent of the sharply rendered subject parts by decreasing the aperture value or record a moving subject more dynamically by slowing the shutter speed.

1 Press the shutter release button halfway to display the aperture and shutter speed values on the screen.

2 While the values are displayed (about 10 seconds), set the desired program shift by rotating the setting wheel.

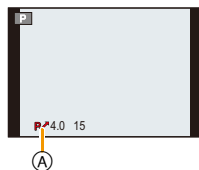

- The operation mode will switch between program shift and exposure compensation (P76) every time the setting wheel is pressed while the values are displayed.
- When program shift is activated, an indication (A) appears on the screen.
- Program shift is canceled
 - when the camera is turned off.
 - when the setting wheel is rotated until the respective indication disappears.

Example of Program Shift

(A): Aperture value

(B): Shutter speed

- 1 Program shift range
- 2 Program shift line chart
- 3 Program shift limit

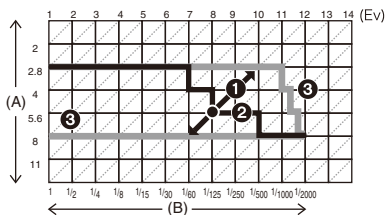

Notes

- EV is an abbreviation of [Exposure Value], a unit indicating an exposure level increment. The EV changes with the aperture value or the shutter speed.
- If more than 10 seconds pass after a program shift was set, it will be canceled, i.e. it will return to the original program mode setting. Even so, the program shift setting is memorized.
- Depending on the brightness of the subject, program shift may not be possible.
- Program shift is available in all ISO sensitivity settings except [ISO].

Focusing

Aim the AF frame at the subject, and then press the shutter release button halfway.

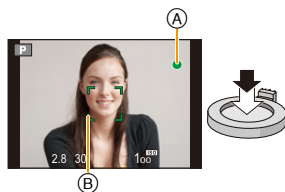

Focus	When the subject is focused	When the subject is not focused
Focus indication (A)	On	Flashes
AF frame (B)	White→Green	White→Red
Sound	Beeps 2 times	Beeps 4 times

- The AF frame is automatically enlarged for certain zoom magnifications and in dark places.

About focus range

The focus range is displayed when operating the zoom.

- The focus range is displayed in red when focusing was not successful after pressing the shutter release button halfway.

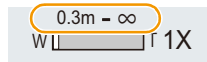

The focus range may change gradually depending on the zoom position.

e.g.: Focusing range during Program Mode

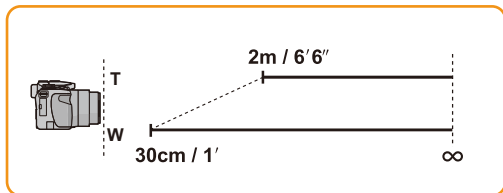

When the subject is not focused as desired (such as when it is not in the center of the composition of the picture you want to take)

- 1 Aim the AF frame at the subject, and then press the shutter release button halfway to set and lock focus and exposure.
- 2 Press and hold the shutter release button halfway as long as you move the camera to compose the picture.



- You can repeat the actions in step 1 before pressing the shutter release button fully.

Subjects and recording conditions which are difficult to focus

- Fast-moving subjects, extremely bright subjects or subjects without contrast
- When recording subjects through windows or near shiny objects
- When it is dark or when the camera is not held still
- When the camera is too close to the subject or when there are both distant and near subject parts in the picture

Snapshot Mode

Recording mode: **[A]** P A S M **[M]** C1 C2 SCN COL

The camera will set the most appropriate settings to match the subject and the recording conditions so we recommend this mode for beginners or those who want to leave the settings to the camera and take pictures easily.

- The following functions are activated automatically.
 - Scene Detection/Backlight Compensation/Intelligent ISO sensitivity control/Auto White Balance/Face Detection/[AFS]/[Quick AF]/[i.Dynamic]/[i.Resolution]/[i.ZOOM]/[Stabilizer]/[AF Assist Lamp]/[Red-Eye Removal]/[Continuous AF]/[Zoom Mic]
- Image quality is fixed to **[Hi]**.

1 Set the mode dial to **[A]**.

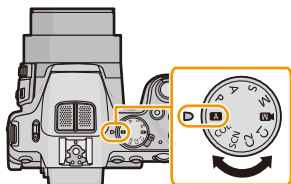

2 Press the shutter release button halfway to focus and then press it fully to take the picture.

(A) Focus indication

- The AF frame **(B)** is placed over the subject's face by the Face Detection function. In other cases, it is placed on the part of the subject which is in focus.
- You can set AF tracking* by pressing [FOCUS]. For details, refer to P90. (AF tracking is canceled by pressing [FOCUS] again.)



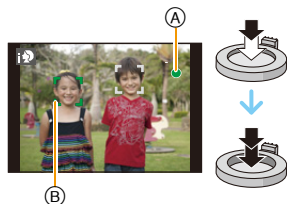





*You cannot use the AF tracking function when [Color Mode] is set to [B&W] or [SEPIA].



Scene Detection

When the camera identifies the optimum scene, the icon of the scene concerned is displayed in blue for 2 seconds, after which its color changes to the usual red.

When taking pictures





A →	 [i-Portrait]	 [i-Scenery]
	 [i-Macro]	 [i-Night Portrait]* ¹
	 [i-Night Scenery]	 [iHandheld Nite Shot]* ²
	 [i-Sunset]	 [i-Baby]* ³

*1 Only when [iA] is selected.

*2 Only displayed when [iHandheld Nite Shot] is set to [ON].

*3 When [Face Recog.] is set to [ON], [iA] will be displayed for birthdays of registered faces already set only when the face of a person 3 years old or younger is detected.

When recording motion pictures

A →	 [i-Portrait]	 [i-Scenery]
	 [i-Low Light]	 [i-Macro]

- [A] is set if none of the scenes are applicable, and the standard settings are set.
- When [iA], [iA] or [iA] is selected, the camera automatically detects a person's face, and it will adjust the focus and exposure accordingly. **(Face Detection)**
- If a tripod is used, for instance, and the camera has judged that camera shake is minimal when the Scene Mode has been identified as [iA], the shutter speed will be set to a maximum of 8 seconds. Take care not to move the camera while taking pictures.
- When [Face Recog.] is set to [ON], and a face similar to the registered face is detected, [R] is displayed in the top right of [iA], [iA] and [iA].
- Due to conditions such as the ones below, different scene modes may be identified for the same subject.
 - Subject conditions: When the face is bright or dark, the size and/or color of the subject, the distance to the subject, the contrast of the subject, when the subject is moving
 - Recording conditions: Sunset, sunrise, under low brightness conditions, when the camera is not held still, when the zoom is used
- To take pictures of an intended scene, it is recommended that you take pictures in the appropriate recording mode.

Backlight Compensation

When there is a backlight, the subject appears darker and the camera will automatically attempt to correct it by increasing the brightness of the picture.

In Snapshot Mode, backlight compensation works automatically. [] is displayed on the screen when backlighting is detected. (Depending on the backlighting conditions, backlighting may not be detected correctly.)

Using the Defocus Control Function

You can easily set the blurriness of the background while checking the screen.

1 Press the setting wheel to display [].

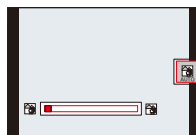

2 Press ◀/▶ or rotate the setting wheel to adjust.

- Press [] to reset the setting to the default state (AUTO).
- To adjust automatically, reset the setting to the default state (AUTO).



3 Press [MENU/SET] or the setting wheel to set.



Changing the menu settings

Following menu items can be set.

Menu	Item
[Rec]	[Picture Size] [*] /[Color Mode]/[Motion Deblur]/[iHandheld Nite Shot]/ [iHDR]/[Face Recog.]
[Motion Picture]	[Rec Mode]/[Rec Quality]
[Setup]	[Clock Set]/[World Time]/[Beep] [*] /[Language]/[O.I.S. Demo.] • Menu items other than those listed above are not displayed, but you can set them in other recording modes.

• For the setting method of the menu, refer to P49.

* Available settings may be different from other recording modes.

Menu items specific to Snapshot Mode



■ [Color Mode]

[Color Mode] can set the color effects of [STANDARD], [Happy], [B&W] or [SEPIA]. When [Happy] is selected, it is possible to automatically take a picture with a higher level of brilliance for the color brightness and vividness.

■ [Motion Deblur]

When [Motion Deblur] is set to [ON], [] is displayed on the recording screen as you press the shutter release button halfway. To reduce subject blurring, the camera automatically sets an optimal shutter speed according to the subject's motion. (In such a case, the resolution may decrease.)

■ [iHandheld Nite Shot]

When [iHandheld Nite Shot] is set to [ON] and [] is detected while taking handheld night shots, a high frequency picture series will be taken and composed into a single picture. This mode is useful if you want to take stunning night shots with minimal camera shake effects and noise, without using a tripod. If the camera is mounted on a tripod or other type of stand, [] will not be detected.

■ [iHDR]

When [iHDR] is set to [ON] and there is, for example, strong contrast between the background and the subject, multiple still pictures are recorded with differing exposures and combined to create a single still picture rich in gradation.

- When [] is displayed on the screen but not otherwise, the iHDR function will work automatically as required.
- In the case that a single picture is going to be composed from multiple pictures, a message indicating that multiple pictures are to be recorded appears on the screen and the respective recording is carried out. Note that multiple picture recording will not take place if the camera determines that it can compensate for the difference in contrast without composing the picture from multiple pictures.
- In the case of composition from multiple pictures, ghost images may appear if the subject was moving.
- In the following cases, a compensated picture is not created.
 - When the zoom factor exceeds 24×.
 - When recording in [Burst].

About the flash

- **Open the flash when it is to be used. (P72)**
- When [iA] is selected, [iA], [iA], [iA], [iA] or [iA] is set depending on the type of subject and brightness.
- When [iA], [iA] is set, Red-Eye Removal is enabled.
- The shutter speeds will be slower during [iA] or [iA].

Recording using Snapshot Plus Mode

You can adjust the brightness and the color balance in addition to the Snapshot Mode function.

- 1 Press [MENU/SET] when in Snapshot Mode.

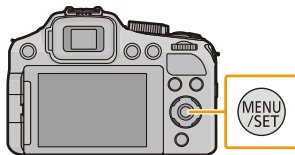

- 2 Press ► to select [A+] and then press [MENU/SET].

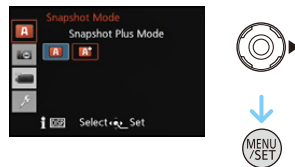

Adjusting brightness, color balance, and background blur

1 Press the setting wheel to display the options.

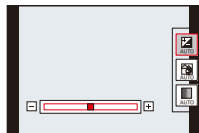

2 Press ▲/▼ to select the item.

[☀️]: Adjust the brightness.

[📷]: Adjust the background blur.

[🎨]: Adjust the color balance.

3 Press ◀️/▶️ or rotate the setting wheel to adjust.

- Press [🔄/↶] to reset the setting to the default state (AUTO).

4 Press [MENU/SET] or the setting wheel to set.

Note

- If you turn the camera off or switch another recording mode, the adjusted slider position returns to the default state (AUTO).

Recording Motion Pictures

Applicable modes: **[A]** **[P]** **[A]** **[S]** **[M]** **[M]** **[C1]** **[C2]** **[SCN]** **[COL]**

This camera can record full high definition motion pictures compatible with the AVCHD format or motion pictures recorded in MP4.

Audio will be recorded in stereo.

1 Start recording by pressing the motion picture button.

- (A) Available recording time
- (B) Elapsed recording time

- It is recommended that you close the flash when recording motion pictures.
- You can record motion pictures fitting each recording mode.
- Release the motion picture button right after you press it.
- The recording state indicator (red) (C) will flash while recording motion pictures.
- Focus can be achieved during recording by pressing [FOCUS].
- For the setting of [Rec Mode] and [Rec Quality], refer to [P141,142](#).

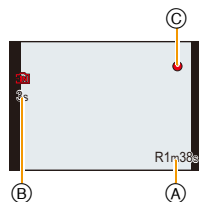
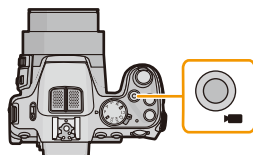

2 Stop the recording by pressing the motion picture button again.

■ About the recording format for recording motion pictures

This camera can record motion pictures in either the AVCHD or MP4 formats.

AVCHD:

You can record high definition quality images with this format. It is suitable for viewing on a large format TV or for saving to disc.

AVCHD Progressive:

The [PSH] in [AVCHD] is a mode that allows motion pictures to be recorded at 1920×1080/50p^{*1} (1920×1080/60p^{*2}), the highest quality^{*3} that complies with the AVCHD standard. Recorded motion pictures can be saved and played back using this camera or the available software (P173).

*1 With camera model 18 190

*2 With camera models 18 191 / 18 192

*3 This means the highest quality for this camera.

MP4:

This is a simpler video format best used when extensive editing is needed, or when uploading videos to the Internet.

■ About the compatibility of the recorded motion pictures

Motion pictures recorded in [AVCHD] or [MP4] may be played back with poor picture or sound quality or playback may not be possible even when played back with equipment compatible with these formats. Also, the recording information may not be displayed properly. In this case, use this camera.

Notes

- The internal memory can only store [VGA] data as [MP4].
- The available recording time displayed on the screen may not decrease regularly.
- Depending on the type of the card, the card access indication may appear for a while after recording motion pictures. This is not a malfunction.
- ISO sensitivity will operate as [AUTO] in Motion Picture Recording except for with Creative Video. Also, [ISO Limit Set] will not function.
- There is a risk that the sound of zooming and button operations and the rubbing of the lens cap string will be recorded, so care is necessary.
- The screen may be blacked out momentarily, or the camera may record noise due to static electricity or electromagnetic fields etc. depending on the environment of the motion picture recording.
- **About zooming while recording motion pictures**
 - Operating the zoom while recording motion pictures, it can take time for the image to come into focus.
 - If Extended Optical Zoom is used before pressing the motion picture button, those settings will be cleared, so the shooting range will change dramatically.
- Even if the aspect ratio setting is the same in still and motion pictures, the angle of view may change at the start of the motion picture recording.
When [Video Rec Area] (P57) is set to [ON], the angle of view during motion picture recording is displayed.
- If you end motion picture recording after a short time when using [Miniature Effect] of the Creative Control Mode, the camera may go on recording for a certain period. Please continue to hold the camera still until the recording finishes.
- It is recommended to use a fully charged battery when recording motion pictures.
- Motion pictures cannot be recorded in the following cases.
 - [Panorama Shot]/[3D Photo Mode] (Scene Mode)
 - [Soft Focus]/[Star Filter] (Creative Control Mode)
- A motion picture will be recorded in the following categories for certain recording modes. A motion picture recording matching each recording mode will be performed for the ones not listed below.















Selected Recording Mode	Recording Mode while recording motion picture
<ul style="list-style-type: none"> • Program Mode • Aperture-Priority Mode • Shutter-Priority Mode • Manual Exposure Mode • [Sports]/[HDR]/[Pet] (Scene Mode) 	Normal motion picture
<ul style="list-style-type: none"> • [Baby1]/[Baby2] (Scene Mode) 	Portrait Mode
<ul style="list-style-type: none"> • [Night Portrait]/[Night Scenery]/[Handheld Night Shot] (Scene Mode) 	Low Light Mode

Recording still pictures while recording motion pictures

Still pictures can be recorded even while recording a motion picture. (simultaneous recording)

During motion picture recording, press the shutter release button fully to record a still picture.

Notes

- You can record up to 20 pictures per motion picture recording.
- During motion picture recording, if you press the shutter release button halfway, the camera will refocus and the noise caused by this operation will be recorded. To prioritize the motion picture image, recording still pictures by fully pressing the shutter release button, or creating still pictures after motion picture recording is recommended. (P45)
- The resolution and the number of recordable pictures are displayed by pressing the shutter release button halfway.
- The recording of a motion picture will continue after taking a still picture.
- Recording motion pictures is done with the electronic shutter, so the recorded still picture may appear distorted.
- Pictures will be recorded with a resolution of [3.5M] (16:9). The picture quality may be different than [3.5M] (16:9) of standard pictures.
- **The flash setting is fixed to .**
- Zooming will stop when a picture is recorded while zooming.
- Only one picture is recorded when Auto Bracketing or White Balance Bracketing is set.
- Simultaneous recording is not possible in the following cases:
 - When [Rec Mode] is set to [VGA] in [MP4]
 - Creative Video Mode
- In [Miniature Effect] of Creative Control Mode, there may be a slight delay between fully pressing the shutter release button and recording.
- The frame rate of a picture series while recording motion pictures is limited to the following. (P77)
 - [] and []/[] cannot be set. These settings will automatically switch to [] and [].
 - [], [], [] or [] cannot be set. These settings will automatically switch to [].
- Only JPEG images are recorded when [Quality] is set to [RAW , [RAW ] or [RAW]. (When set to [RAW ] or [RAW], still pictures will be recorded in [Quality] of [].)

Playing Back Pictures ([Normal Play])

Press [▶].

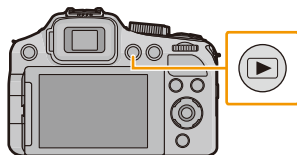

■ To finish playback

Press [▶] again, press the motion picture button or press the shutter release button halfway.

📌 Notes

- This camera complies with the DCF standard “Design rule for Camera File system” established by JEITA “Japan Electronics and Information Technology Industries Association” and with Exif “Exchangeable Image File Format”. Files which do not comply with the DCF standard cannot be played back.
- The lens barrel retracts about 15 seconds after switching from recording to playback mode.
- Pictures recorded with another camera may not be played back on this camera.

Selecting a picture

Press ◀ or ▶.

◀: To play back the previous picture

▶: To play back the next picture

Ⓐ File number

Ⓑ Picture number

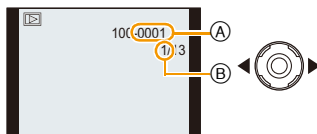

• If you press and hold ◀/▶, you can play back the pictures in succession.

• The speed of picture forwarding/rewinding changes depending on the playback status.

Displaying Multiple Images (Multi Playback)

Rotate the zoom lever towards [W].

1 image → 12 images → 30 images → Calendar screen display

(A) Number of the selected picture and the total number of recorded pictures

- Rotate the zoom lever towards [T] to return to the former display.
- Pictures displayed using [!] cannot be played back.

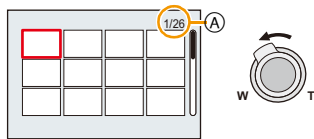

To return to normal playback

Press ▲/▼/◀/▶ to select a picture and then press [MENU/SET].

Using the Playback Zoom

Rotate the zoom lever towards [T].

1× → 2× → 4× → 8× → 16×

- When you rotate the zoom lever towards [W] after enlarging the picture, the magnification becomes lower.
- When you change the magnification, the zoom position indication (A) appears for about 1 second, and the position of the enlarged section can be moved by pressing ▲/▼/◀/▶.
- The more a picture is enlarged, the more its quality deteriorates.

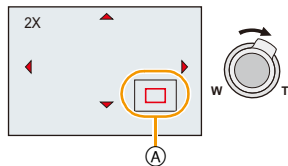

Switching the displayed image while maintaining a magnification setting

You can switch the displayed image while maintaining the same magnification and position.

Rotate the setting wheel to select an other picture while a magnification is set.

- The position of the magnified section returns to the center in the following cases.
 - Images with different aspect ratios
 - Images with different resolutions
 - Images with a different rotation direction (when [Rotate Disp.] is set to [ON])

Enlarging the focused part of the subject (display focus point)

The camera memorizes the focused part of the subject during the recording, and can enlarge the image with that part as the center.

Press [FOCUS] during image playback.

- The focused part of the subject may not be at the center of the enlargement when it is at the edge of the image.
- The setting returns to the original enlargement if [FOCUS] is pressed again.
- The following pictures cannot be enlarged because there is no part of the subject in focus:
 - Pictures that were taken without focusing
 - Pictures that were taken with manually focused
 - Pictures that were taken with a different camera

Playing Back Motion Pictures

This camera was designed to play back motion pictures using the AVCHD, MP4 and QuickTime Motion JPEG formats.

Press ◀▶ to select a recording with a motion picture icon (such as [MP4 VGA]/[AVCHD FSH]), and then press ▲ to play back.

(A) Motion picture icon

(B) The motion picture recording time

- After playback starts, the elapsed time is displayed on the screen. For example, 8 minutes and 30 seconds is displayed as [8m30s].
- Some information (recording information, etc.) is not displayed for motion pictures recorded in [AVCHD].
- High speed motion pictures are identified by the [7.5] icon.

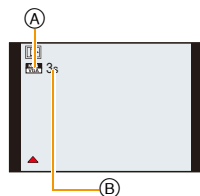

Operations performed during Motion Picture Playback

The cursor displayed during playback is the same as ▲/▼/◀▶.

▲	Play/Pause	
▼	Stop	
◀	Fast rewind* Frame-by-frame rewind (while pausing)	
▶	Fast forward* Frame-by-frame forward (while pausing)	
[W]	Reduce volume level	
[T]	Increase volume level	

* The fast forward/rewind speed increases if you press ▶/◀ again.

Notes

- When using a high capacity card, it is possible that fast rewinding may be slower than usual.
- To playback the motion pictures recorded by this camera on a computer, use the available software (P173).
- Motion pictures recorded with other cameras may not be played back on this camera.
- When playing back high speed motion pictures, the motion picture recording time differs to the actual playback time.
- **With camera model 18 190:**
Motion pictures recorded with [Miniature Effect] in Creative Control Mode play back at approximately 8 times speed.
- **With camera models 18 191 / 18 192:**
Motion pictures recorded with [Miniature Effect] in Creative Control Mode play back at approximately 10 times speed.

Creating Still Pictures from a Motion Picture

You can create a single still picture from a recorded motion picture.

1 Press ▲ to pause motion picture playback.

2 Press [MENU/SET].

- A confirmation screen is displayed. It is executed when [Yes] is selected. Exit the menu after it is executed.

Notes

- The picture is saved with the following resolutions.

Recording format		Resolution
[AVCHD]		2 M (16:9)
[MP4]	([FHD]/[HD])	2 M (16:9)
	([VGA])	0.3 M (4:3)

- You may not be able to save still pictures from a motion picture taken on other equipment.
- Still pictures created from a motion picture may have a lower resolution than with normal picture quality.

Deleting Pictures

Once deleted, pictures cannot be recovered.

- The picture being played back is deleted, regardless of whether it is recorded on the internal memory or the card.
- Pictures that do not comply with the DCF standard or those that are protected cannot be deleted.

Press [▶].

Deleting a single picture

Select the picture to be deleted, and then press [🗑️/↩️].

- A confirmation screen is displayed.
The picture is deleted by selecting [Yes].

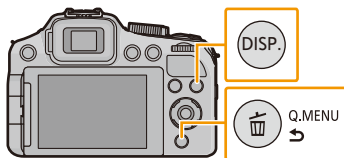

Deleting multiple pictures (up to 100) or all the pictures

1 Press [🗑️/↶].

2 Press ▲/▼ to select [Delete Multi] or [Delete All] and then [MENU/SET].

- [Delete All] → A confirmation screen is displayed. The pictures are deleted by selecting [Yes].
- It is possible to delete all pictures except the ones set as favorite when [All Delete Except Favorite] is selected with the [Delete All] set.



3 (When [Delete Multi] is selected) Press ▲/▼/◀/▶ to select the picture, and then [DISP.] to set. (Repeat this step.)

- [🗑️] appears on the selected pictures. If [DISP.] is pressed again, the setting is canceled.

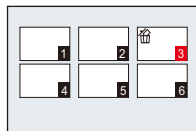

4 (When [Delete Multi] is selected) Press [MENU/SET].

- A confirmation screen is displayed. The pictures are deleted by selecting [Yes].

Notes





- Picture series groups (pictures with the picture series icon [📁]) will be treated as a single picture. Deleting a picture series group will delete all pictures in the group. (P147)
- Do not turn the camera off while deleting. Use a sufficiently charged battery.
- Depending on the number of pictures to be deleted, it may take some time to delete them.

Setting the Menu

The camera features menus that allow you to choose the settings for taking pictures and playing them back as you like. There are also menus that enable you to have more fun with the camera and use it more easily.

In particular, the [Setup] menu contains some important settings relating to the camera's clock and power. Check the settings of this menu before proceeding to use the camera.

■ Types of menus

Menu	Description of settings
 [Rec] (P127 to 140)	This menu includes settings for the coloring, sensitivity, aspect ratio, resolution and other aspects of the pictures you are recording.
 [Motion Picture] (P141 to 144)	This menu includes settings for the [Rec Mode], [Rec Quality], and other aspects for motion picture recording.
 [Playback Mode] (P149 to 153)	This menu includes settings for the playback methods such as playback or slide show of only the pictures set as [Favorite].
 [Playback] (P154 to 166)	This menu includes settings for protection, cropping or print settings, etc. of recorded pictures.
 [Setup] (P52 to 65)	This menu is for the clock settings, selecting the operating beep tone settings and other settings which make it easier for you to operate the camera.

Setting menu items

- If you set [Menu Resume] (P64) in the [Setup] menu to [ON], the screen shows the last selected menu item when the camera was turned off.

Example: In the [Rec] menu, change [AF Mode] from [■] (1-area-focusing) to [👤] (Face Detection)

1 Press [MENU/SET].

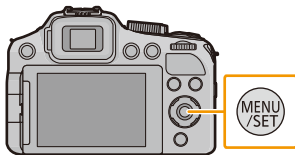

2 Press ▲/▼ or rotate the setting wheel to select the menu item.

- It will switch to the next page when you reach the bottom.
(It will also switch by rotating the zoom lever.)



3 Press ► or the setting wheel.

- Depending on the menu item, its setting may not appear or it may be displayed in a different way.

4 Press ▲/▼ or rotate the setting wheel to select the settings.

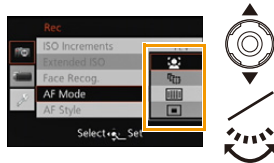

5 Press [MENU/SET] or the setting wheel to set.

■ Close the menu

Press [MENU/SET] or press the shutter release button halfway.

■ Switching to other menus

e.g.: Switching to the [Setup] menu from [Rec] menu

1 Press ◀.



2 Press ▼ or rotate the setting wheel to select the [Setup] menu icon [🔧].



3 Press ▶ or the setting wheel.

- Select a menu item next and set it.



📌 Note

- There are functions that cannot be set or used depending on the modes or menu settings being used on the camera due to the specifications.

Using the Quick Menu

By using the Quick Menu, some of the menu settings can be easily found.

- The features that can be set using Quick Menu are determined by the mode or a display style the camera is in.

- 1 Press [Q.MENU] when recording.

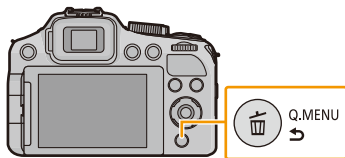

- 2 Press ◀/▶ to select the item and then [MENU/SET].

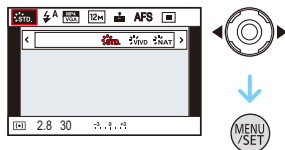

- 3 Press ◀/▶ to select the setting and then [MENU/SET] to set.

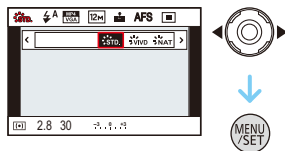

- 4 Press [Q.MENU] or the shutter release button halfway to close the menu.

■ Using the Quick Menu with the setting wheel

You can also set the Quick Menu with the setting wheel, without changing your position or the camera angle when using the viewfinder.

- 1 Press [Q.MENU] in the Recording Mode.
- 2 Rotate the setting wheel to select the item, and then press it.



- 3 Rotate the setting wheel to select the setting, and then press it to set.

- Exit the menu after it is set.









About the Setup Menu

[Clock Set], [Economy] and [Auto Review] are important items. Check their settings before using them.

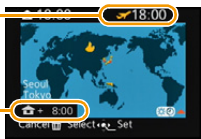
[Clock Set]	—
-------------	---

- Refer to P24 for details.

[World Time]	<p>Set the time in your home area and travel destination. You can display the local times at the travel destinations and record them on the pictures you take.</p> <p>After selecting [Destination] or [Home], press ◀/▶ to select an area, and then [MENU/SET] to set.</p> <ul style="list-style-type: none"> • Set [Home] first thing after purchasing. [Destination] can be set after setting up [Home].
	<p> [Destination]: Travel destination area</p> <p>(A) Current time of the destination area (B) Time difference from home area</p> <p> [Home]: Your home area</p> <p>(C) Current time (D) Time difference from GMT (Greenwich Mean Time)</p> <div style="display: flex; justify-content: space-around; align-items: flex-start;"> <div style="text-align: center;"> <p>(A) </p> </div> <div style="text-align: center;"> <p>(B) </p> </div> <div style="text-align: center;"> <p>(C) </p> </div> <div style="text-align: center;"> <p>(D) </p> </div> </div>

- Press ▲ if you are using Summer Time []. (The time will move forward by 1 hour.) Press ▲ once more to return to the normal time.
- If you cannot find the travel destination in the areas displayed on the screen, set by the time difference from the home area.

[Travel Date]	Departure date and return date of the trip as well as the name of the travel destination can be set. You can display the number of days that have passed when playing back the pictures and stamp it on the recorded pictures with [Text Stamp] (P155).	
	[Travel Setup]:	
	<p>[SET]: Departure date and return date are set. Elapsed days (how many days after) of the trip are recorded.</p> <p>[OFF]</p> <ul style="list-style-type: none"> The travel date is automatically canceled if the current date is after the return date. If the [Travel Setup] is set to [OFF], [Location] will be also set to [OFF]. 	
	[Location]:	
	<p>[SET]: Travel destination is recorded at the time of recording.</p> <p>[OFF]</p> <ul style="list-style-type: none"> For details on how to enter characters, refer to “Entering Text” on P126. 	

- The travel date is calculated using the date in the clock setting and the departure date you set. If you set [World Time] to the travel destination, the travel date is calculated using the date in the clock setting and the travel destination setting.
- The travel date setting is memorized even when the camera is turned off.
- The number of days that have passed since the departure date is not recorded before the departure date.
- [Travel Date] cannot be set for motion pictures recorded with [AVCHD].
- [Location] cannot be recorded when taking motion pictures.
- [Travel Date] cannot be set in the Snapshot Mode. Setting of other recording modes will be reflected.

[Beep]	This allows you to set the beep and shutter sound.	
	[Beep Level]:	[Shutter Vol.]:
	<p>[] ([High])</p> <p>[] ([Low])</p> <p>[] ([OFF])</p>	<p>[] ([High])</p> <p>[] ([Low])</p> <p>[] ([OFF])</p>
	[Beep Tone]:	[Shutter Tone]:
[]/[]/[]	[]/[]/[]	

[Volume]	Adjust the volume of the speaker to any of 7 levels.
-----------------	--

- When you connect the camera to a TV, the volume of the TV speakers does not change. Also, when connected, no sound is output from the camera speakers.

[Cust.Set Mem.]	Up to 4 current camera settings can be registered as custom settings.
	[C1]/[C2-1]/[C2-2]/[C2-3]

- Refer to [P121](#) for details.

[AF/AE LOCK /Fn2]	The function of the [AF/AE LOCK] button can be switched between AF/AE Lock and Fn(function).
	[AF/AE LOCK]/[Fn2]

- At the time of purchase, AF/AE Lock is selected.

[Fn Button Set]	Certain menu items can be assigned to the function button. You may find it convenient to register a menu item that you often use. [Fn1 Button Set]/[Fn2 Button Set]/[Fn3 Button Set]
------------------------	--

- Refer to [P98](#) for details.

[Side Lever]	Switches the function of the zoom/focus rocker to zoom or to focus when the camera is set to manual focusing.
	<p>[ZOOM]: Control the zoom by sliding the zoom/focus rocker. (P69)</p> <p>[FOCUS]: Sets the focus when the camera is set to manual focusing. (P93) Sliding the zoom/focus rocker when AF is locked (when the shutter release button is pressed halfway, or AF is locked with [AF/AE Lock]) will slightly adjust the focus when the camera is set to auto focusing.</p>

- The focus cannot be slightly adjusted with AF locked when recording motion pictures in Snapshot Mode.

[LCD Display]/ [Viewfinder]	Brightness, color, or red or blue tint of the monitor/viewfinder is adjusted.
	<p>[Brightness]: Adjusts the brightness.</p> <p>[Contrast · Saturation]: Adjusts the contrast or clarity of colors.</p> <p>[Red Tint]: Adjusts the red tint.</p> <p>[Blue Tint]: Adjusts the blue tint.</p> <p>1 Select the settings by pressing ▲/▼, and adjust with ◀/▶. 2 Press [MENU/SET] to set.</p>



- This operation will adjust the monitor when it is in use, or the viewfinder when it is in use.
- Some subjects may appear differently than in reality on the monitor/viewfinder. However, this does not affect the recorded pictures.

[LCD Mode]	These menu settings make it easier to see the monitor image when you are in bright places.
	<p><input checked="" type="checkbox"/>* [Auto Power LCD]*: The monitor brightness is adjusted automatically depending on the ambient brightness.</p> <p><input type="checkbox"/>* [Power LCD]: The monitor becomes brighter and easier to see even when taking pictures outdoors.</p> <p>[OFF] * Can be set only during recording mode.</p>





- The brightness of the pictures displayed on the monitor is increased so some subjects may appear differently than in reality on the monitor. However, this does not affect the recorded pictures.
- The monitor automatically returns to normal brightness after 30 seconds when recording in Power LCD Mode. Press any button to turn the monitor bright again.
- When [LCD Mode] is set, the battery usage time is reduced.

[EVF Disp.Style]	This will set the display style of the Viewfinder.
	<p><input type="checkbox"/>: Viewfinder style</p> <p><input checked="" type="checkbox"/>: Monitor style</p>

- Refer to P66 for details.

[LCD Disp.Style]	This will set the display style of the monitor.
	 : Viewfinder style
	 : Monitor style

• Refer to [P66](#) for details.

[Guide Line]	This will set the pattern of guide lines displayed when taking a picture.	   : Press ▲/▼/◀/▶ to determine the position, then press [MENU/SET] to set. Press [DISP.] to return to the default position. [OFF]	
---------------------	---	--	---

- When you align the subject on the horizontal and vertical guidelines or the cross point of these lines, you can take pictures with well-designed composition by determining the size, the slope and the balance of the subject.
- In [Panorama Shot] in Scene Mode, the guideline is not displayed.

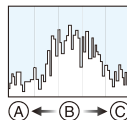

[Histogram]	This allows you to set to display the histogram or not.
	[ON]/[OFF]
	<p>A histogram is a graph that displays brightness along the horizontal axis (black to white) and the number of pixels at each brightness level on the vertical axis. It allows you to easily check a picture's exposure.</p> <p>(A) dark (B) optimal (C) bright</p>



- **When the recorded picture and the histogram do not match each other under the following conditions, the histogram is displayed in orange.**
 - When the Manual Exposure Assistance is other than [0] during exposure compensation or in the Manual Exposure Mode
 - When the flash is activated
 - When the flash is closed
 - When the brightness of the screen is not correctly displayed in dark places
 - When the exposure is not adequately set
- The histogram is an approximation in Recording Mode.
- The histogram of a picture may not match in Recording Mode and Playback Mode.
- The histogram displayed in this camera does not match histograms displayed by picture editing software used in computers etc.
- Histograms are not displayed in the following cases.
 - Snapshot Mode
 - Multi Playback
 - When recording motion pictures
 - Playback Zoom
 - When an HDMI mini cable is connected
 - Calendar Search

[Video Rec Area]	The angle of view for motion picture recording can be checked.
	[ON]/[OFF]

- The motion picture recording area display is only an approximation.
- The recording area display may disappear when zooming to longer focal lengths depending on the resolution setting.
- The setting will be fixed to [OFF] during the Snapshot Mode.

[Remaining Disp.]	This will switch between displaying the number of recordable pictures and available recording time.
	<p> ([Remaining Shots]): This will display the number of recordable pictures for still pictures.</p> <p> ([Remaining Time]): This will display the available recording time for motion pictures.</p>

[Highlight]	When the Auto Review function is activated or when playing back, white saturated areas appear flashing in black and white. This does not affect the recorded image.
	[ON]/[OFF]

- If there are any white saturated areas, we recommend compensating the exposure towards negative (P76) referring to the histogram and then taking the picture again. It may result in a better quality picture.
- There may be white saturated areas if the distance between the camera and the subject is too close when taking pictures with the flash.
- Highlighting does not work during Multi Playback, Calendar Search, Playback Zoom, or Motion Picture Playback.

[ON]**[OFF]**

[Expo.Meter]	Set whether or not to display the shutter speed/aperture combination.
	[ON]/[OFF]

- Set to [ON] to display the [Expo.Meter] when correcting exposure, performing Program Shift, setting aperture, and setting shutter speed.
- Unsuitable areas of the ranges are displayed in red.
- When [Expo.Meter] is not displayed, switch the display information for the screen by pressing [DISP.]. (P66)
- The [Expo.Meter] disappears after approximately 4 seconds if no operation is performed.

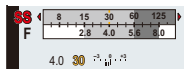

[Lens Resume]	The camera memorizes a zoom position and an MF (Manual Focus) position when it is turned off.
	[Zoom Resume]: When you turn the camera on, the zoom position when you last turned the camera off are automatically restored. [ON]/[OFF]
	[MF Resume]: This function will memorize the manually focused position. It will resume this memorized focus position when you return to manual focus recording. [ON]/[OFF]

- The MF position will be memorized in the following cases:
 - When the camera is turned off
 - When switching to a type of focus other than manual
 - When switched to Playback Mode
- The zoom position will be set to the shortest focal length when the [Zoom Resume] is set to [OFF].
- When [MF Resume] is set to [OFF], the MF position will be the distance manually focused at the time of recording.
- Depending on the recording conditions, the memorized MF positions and resumed MF positions might be different.

[MF Assist]	In Manual Focus, the screen to facilitate focusing on the subject is displayed.
	[ON]: The center of the image is enlarged over the whole screen. [OFF]

- Refer to [P94](#) for details.

[Economy]	You can conserve the battery life by setting these menus. Also, it will turn off the monitor automatically when not in use to prevent discharge of the battery.
	[Sleep Mode]: The camera is automatically turned off if the camera has not been used for the time selected. [10MIN.]/[5MIN.]/[2MIN.]/[1MIN.]/[OFF]
	[Auto LCD Off]: The camera is automatically turned off if it has not been used for the time selected. [30SEC.]/[15SEC.]/[OFF]
	[Live View Mode]: Sets the monitor to display in such a way that power consumption is reduced. [NORMAL]/[ECO]

- Press the shutter release button halfway or turn the camera off and on to cancel [Sleep Mode].
- [Sleep Mode] is set to [5MIN.] in Snapshot Mode.
- Press any button to turn on the monitor again.
- [Sleep Mode] does not work in the following cases.
 - When connecting to a computer or a printer
 - When recording or playing back motion pictures
 - During a slide show
- [Auto LCD Off] does not work in the following cases.
 - When connecting to a computer or a printer
 - With Snapshot Mode
 - While the Self-timer is set
 - When recording or playing back motion pictures
 - During a slide show
 - While the menu screen is displayed
- [Sleep Mode] is fixed to [2MIN.] when [Auto LCD Off] is set to [15SEC.] or [30SEC.].
- When [Live View Mode] is set to [ECO] the image quality on the recording screen may be worse than when it is set to [NORMAL], but this does not affect the recorded image.
- When [Live View Mode] is set to [NORMAL], the battery usage time is reduced.

[Play on LCD]	If you selected the viewfinder in a Recording Mode, the display will automatically switch to the monitor when playing back the pictures.
	[ON] [OFF]

[Auto Review]	<p>Sets the length of time that the picture is displayed after taking the still picture.</p> <p>[HOLD]: The pictures are displayed until one of the buttons is pressed.</p> <p>[2 SEC.] [1 SEC.] [OFF]</p>
----------------------	--



- [Auto Review] is activated regardless of its setting in the following cases.
 - When using Auto Bracketing
 - During Continuous Mode
- The Auto Review function is fixed to [2 SEC.] in the following cases.
 - Snapshot Mode
- [Auto Review] does not work when recording motion pictures.

[No.Reset]	Resets the file number of the next recording to 0001.
-------------------	---

- The folder number is updated and the file number starts from 0001.
- A folder number between 100 and 999 can be assigned.
When the folder number reaches 999, the number cannot be reset. We recommend formatting the card (P65) after saving the data on a computer or elsewhere.
- To reset the folder number to 100, format the internal memory or the card first and then use this function to reset the file number.
A reset screen for the folder number will then appear. Select [Yes] to reset the folder number.

[Reset]	The [Rec] or [Setup] menu settings are reset to the initial settings.
----------------	---

- When the [Reset] setting is selected during recording, the operation that resets the lens is also performed at the same time. You will hear the sound of the lens operating but this is normal and not indicative of malfunctioning.
- When the Recording Mode settings are reset, data registered with [Face Recog.] will be also reset, too.
- The folder number and the clock setting are not changed.
- When [Setup] menu settings are reset, the following settings are also reset.
 - The birthday and name settings for [Baby1]/[Baby2] and [Pet] in Scene Mode.
 - The [Travel Date] setting. (Departure date, return date, destination)
 - The [World Time] setting.
 - The [Cust.Set Mem.] setting.
 - Position memorized in [Lens Resume]/[Menu Resume].

[USB Mode]	Select the USB communication system after or before connecting the camera to your computer or your printer with the USB cable (supplied).
	<p> [Select on connection]: Select either [PC] or [PictBridge(PTP)] if you connected the camera to a computer or a printer supporting PictBridge.</p> <p> [PictBridge(PTP)]: Set after or before connecting to a printer supporting PictBridge.</p> <p> [PC]: Set after or before connecting to a computer.</p>



[Output]	This sets how the camera connects to a television etc.
	<p>[Video Out]: (Menu item only available with model no. 18 190.) Set to match the television color system in each country.</p> <p>[NTSC]: Video output is set to NTSC system.</p> <p>[PAL]: Video output is set to PAL system.</p> <ul style="list-style-type: none"> • This will work when the AV cable or HDMI mini cable (available as accessory, see P7) is connected.
	<p>[TV Aspect]: Set to match the type of TV.</p> <p>16:9 [16:9]: When connecting to a 16:9 screen TV.</p> <p>4:3 [4:3]: When connecting to a 4:3 screen TV.</p> <ul style="list-style-type: none"> • This will work when the AV cable is connected.

[HDTV Link]	This sets the camera so it can be controlled by the remote control of the HDTV compatible equipment which is automatically coupled with the camera using HDMI mini cable (available as accessory, see P7).
	<p>[ON]: Remote control operation of the HDTV Link compatible equipment is enabled. (Not all operations are possible) Button operation of the camera will be limited.</p> <p>[OFF]: Operation is performed with the buttons on the camera.</p>

- This will work when the HDMI mini cable (available as accessory, see [P7](#)) is connected.
- Refer to [P169](#) for details.

[3D Playback]	This sets the output method for 3D pictures.
	<p>[3D]: Set when connecting to a 3D compatible television.</p> <p>[2D]: Set when connecting to a television not compatible with 3D. Set this when you would like to view pictures in 2D (conventional image) on a 3D compatible television.</p>

- This will work when the HDMI mini cable (available as accessory, see [P7](#)) is connected.
- Refer to [P171](#) for the method to playback 3D pictures in 3D.

[Rotate Disp.]	This mode allows you to display pictures vertically if they were recorded holding the camera vertically.
	<p> ([On]): Rotates pictures on a TV and the LCD display so that they are displayed vertically.</p> <p> ([External Only]): Pictures are displayed vertically by rotating when played back on TV.</p> <p>[OFF]</p>

- Refer to [P42](#) for information about how to play back pictures.
- When you play back pictures on a computer, they cannot be displayed in the rotated direction unless the OS or software is compatible with Exif. Exif is a file format for still pictures which allows recording information, etc. to be added. It was established by “JEITA (Japan Electronics and Information Technology Industries Association)”.
- It may not be possible to rotate pictures that have been recorded with other equipment.
- The display is not rotated during Multi Playback.

[Scene Menu]	This sets the screen that appears as you switch the mode dial to [SCN].
	<p>[AUTO]: Display the Scene Mode menu.</p> <p>[OFF]: Display the recording screen of the currently selected Scene Mode.</p>

[Menu Resume]	The last operated menu position is saved even if the camera is turned off.
	[ON]/[OFF]

[Version Disp.]	—
------------------------	---

- Allows checking which version of firmware is on the camera.
- Press [MENU/SET] on the version display screen to display information about the software on the camera.

[Format]	The internal memory or the card is formatted. Formatting irretrievably deletes all the data, so check the data carefully before formatting.
-----------------	---

- Use a battery with sufficient capacity. Do not turn the camera off during formatting.
- If a card is inserted, only the card is formatted. To format the internal memory, remove the card.
- If the card has been formatted on a computer or other equipment, format it on the camera again.
- It may take longer to format the internal memory than the card.
- If you cannot format, contact your Leica dealer or a Leica agency.

[Language]	Set the language displayed on the screen.
-------------------	---

- If you set a different language by mistake, select [00] from the menu icons to set the desired language.

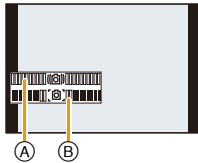
[O.I.S. Demo.]	Displays the amount of camera shake the camera has detected.
	<p>Ⓐ Amount of camera shake</p> <p>Ⓑ Amount of camera shake after correction</p> 

- The Stabilizer function is switched between ON and OFF every time [MENU/SET] is pressed during the [O.I.S. Demo.].
- [O.I.S. Demo.] is an approximation.

About the Monitor/the Viewfinder

Press [DISP.] to change.

- When the menu screen appears, the [DISP.] button is not activated. During Playback Zoom, while playing back motion pictures and during a Slide Show, you can only select (E) or (G).
- You can select between [] (monitor style) and [] (viewfinder style) for each of the monitor and the Viewfinder display screen using [LCD Disp.Style] and [EVF Disp.Style] in the [Setup] menu.

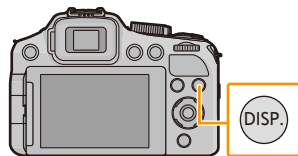

In Recording Mode

[] (monitor style)

(A) Normal display

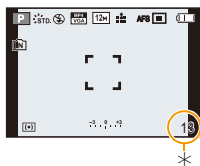

(B) No display

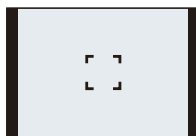

[] (viewfinder style)

(C) Normal display

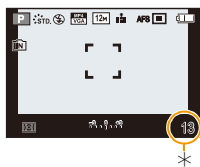

(D) Normal display



- * You can switch between available recording time and number of recordable pictures by setting [Remaining Disp.] in [Setup] menu.

In Playback Mode

Ⓔ Normal display



Ⓕ Display with recording information*1



Ⓖ No display*2

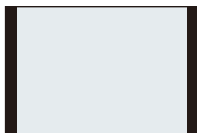

*1 If the [Histogram] in [Setup] menu is set to [ON], the histogram will be displayed.

*2 The name of the registered person in [Face Recog.] is displayed when [DISP.] is pressed.

Using the Zoom

Applicable modes: **[A]** **[P]** **[A]** **[S]** **[M]** **[MEM]** **[C1]** **[C2]** **[SCN]** **[COL]**

Using the Optical Zoom/the Extended Optical Zoom (EZ)/the Intelligent Zoom/the Digital Zoom

You can determine how much of a subject is to be captured / how large a subject is to be rendered by selecting the appropriate focal length, i.e. by zooming.

Extended Optical Zoom works except when the maximum resolution is set. This function allows you to utilize even longer focal lengths without the image quality deteriorating.

To make subjects appear further away use shorter focal lengths

Rotate the zoom lever towards **[W]**.



To make subjects appear closer use longer focal lengths

Rotate the zoom lever towards **[T]**.



■ Changing the zoom speed

The zoom speed becomes slower when the rotation angle is small and faster when it is large.

- Ⓐ Fast
- Ⓑ Slow

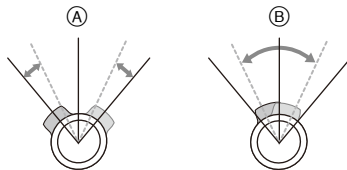

■ Storing the zoom position (Zoom resume)

- Refer to [P59](#) for details.

■ Controlling the zoom with the zoom/focus rocker

Using the zoom/focus rocker to control the zoom when taking pictures with the viewfinder may facilitate holding the camera still and so reduce blurring due to camera shake.

- When controlling the zoom with the zoom/focus rocker, set [Side Lever] in the [Setup] menu to [ZOOM]. (P54)
- You can operate the zoom at 2 speeds. The zoom speed becomes slower when the sliding distance is small and faster when it is large.
- You cannot use the zoom lever and zoom/focus rocker simultaneously.

To make subjects appear closer use longer focal lengths

Slide the zoom/focus rocker towards [T].

To make subjects appear further away use shorter focal lengths

Slide the zoom/focus rocker towards [W].



Types of zooms

Feature	Optical Zoom	Extended Optical Zoom (EZ)
Maximum magnification	24×	46.9×*1
Picture quality	No deterioration	No deterioration
Conditions	None	[Picture Size] with EZ (P129) is selected.

*1 This includes the optical zoom magnification. The magnification level differs depending on [Picture Size] setting.

The zoom functions below can also be used to further increase the zoom magnification.

Feature	Intelligent Zoom	Digital Zoom
Maximum magnification	2×	4×*2
Picture quality	Limited deterioration	The higher the magnification level, the greater the deterioration.
Conditions	[i.Resolution] (P135) on the [Rec] menu is set to [i.ZOOM].	[Digital Zoom] (P135) on the [Rec] menu is set to [ON].

*2 2× when [i.Resolution] in the [Rec] menu is set to [i.ZOOM].

Screen display

- (A) Extended Optical Zoom indication
- (B) Optical Zoom range
- (C) Intelligent Zoom range
- (D) Digital Zoom range
- (E) Zoom magnification



- When using the zoom function, an approximation of the focus range will appear in conjunction with the zoom display bar. [Example: 0.3m (1') -∞]

Notes

- The indicated zoom magnification is an approximation.
- The lens barrel extends or retracts according to the zoom position. Take care not to interfere with the motion of the lens barrel while the zoom lever is rotated.
- When you rotate the zoom lever, you may hear some sound from the camera or the camera may vibrate. This is not a malfunction.
- When using the Digital Zoom, we recommend using a tripod and the Self-timer (P80).
- The Extended Optical Zoom cannot be used in the following cases.
 - [Motion Deblur] (Snapshot Mode)
 - When Continuous Mode is set to [C], [C] or [C].
 - [Toy Effect] (Creative Control Mode)
 - [Panorama Shot]/[HDR]/[High Sens.]/[3D Photo Mode] (Scene Mode)
 - When recording motion pictures
 - When [Quality] is set to [RAW], [RAW] or [RAW]
- The Intelligent Zoom cannot be used in the following cases.
 - [Motion Deblur] (Snapshot Mode)
 - When Continuous Mode is set to [C], [C] or [C].
 - [Toy Effect] (Creative Control Mode)
 - [Panorama Shot]/[Handheld Night Shot]/[HDR]/[High Sens.]/[3D Photo Mode] (Scene Mode)
- [Digital Zoom] cannot be used in the following cases.
 - Snapshot Mode
 - When Continuous Mode is set to [C], [C] or [C].
 - [Toy Effect]/[Miniature Effect] (Creative Control Mode)
 - [Panorama Shot]/[Handheld Night Shot]/[HDR]/[High Sens.]/[3D Photo Mode] (Scene Mode)
 - [High Speed Video] (Creative Video Mode)
 - When [Quality] is set to [RAW], [RAW] or [RAW]

Using the Built-In Flash

Applicable modes: **A** **P** **A** **S** **M** CM **C1** **C2** **SCN** **COL**

■ To open/close the flash unit

Ⓐ To open the flash unit

Push the flash release slider in the direction indicated by the arrow.

Ⓑ To close the flash unit

Push the flash unit down until it clicks into place.

📌 Notes

- Be sure to close the flash when it is not in use.
- The flash setting is fixed to **[☀]** while the flash is closed.
- **Be careful not to pinch your fingers when you close the flash.**
- Be sure to keep the flash unit clean, clear of dust and avoid exposure to anything sticky. This may cause it to stick and not open.
- You should not close the flash unit by pushing the microphone section or its periphery. Forcibly closing the flash can damage the camera.

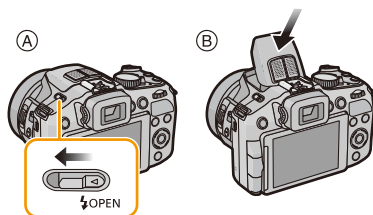

Switching flash modes









Set the flash mode to match the recording situation.

- Open the flash.

1 Select [Flash] in the [Rec] menu. (P49)

2 Press ▲/▼ to select a mode and then [MENU/SET].

- Exit the menu after it is set.

Settings	Description of the modes
 A (([Auto])  A (([iAuto]) ^{*1}	The flash is automatically fired when the recording conditions make it necessary.
 A  (([Auto/Red-Eye]) ^{*2}	The flash is automatically fired when the recording conditions make it necessary. It is fired once immediately before the actual exposure to reduce the red-eye phenomenon (the pupils of the subjects' eyes appear red in the picture) and then again for the actual exposure. • Use this mode for pictures of people in low lighting conditions.
 (([Forced Flash On])	The flash is fired every time regardless of the recording conditions. • Use this mode when your subject is back-lit or under fluorescent light.
 S  (([Slow Sync./Red-Eye]) ^{*2}	The flash is automatically fired when the recording conditions make it necessary. Also, the appropriate longer shutter speeds for the ambient light situations are used. Dark backgrounds will be rendered brighter. Simultaneously this mode reduces the red-eye phenomenon. • Use this mode for pictures of subjects in front of a dark background.
 (([Forced Flash Off])	The flash is never fired. • This item is not displayed on the menu. To set the camera to [🚫], close the flash. • Use this mode when you take pictures in places where the use of the flash is not permitted.

*1 This can be set only when Snapshot Mode is set. The icon changes depending on the type of subject and brightness. (P36)









*2 The flash is fired twice. The subject should not move until the second flash has been fired.

The interval between the two flashes depends on the brightness of the subject. When [Red-Eye Removal] (P138) on the [Rec] menu is set to [ON], [🔧] appears with the flash icon.

■ Available flash modes in Recording Mode

The available flash modes depend on the recording mode.

(○: Available, —: Not available, ●: Scene Mode initial setting)

					
A *	○*	—	—	—	○
P / A	○	○	○	○	○
S / M	○	○	○	—	○
	○	●	○	—	○
	—	—	—	—	●
	●	—	○	—	○
	—	—	—	●	○

* [A] is displayed.

- The flash mode may change if the recording mode is changed. Reset the flash mode again if necessary.
- The flash mode is memorized even if the camera is turned off. However, the Scene Mode flash mode is reset to the initial setting when the Scene Mode is changed.
- The flash is not available when recording motion pictures.

■ The available flash range

- The available flash range is an approximation.

	Wide	Tele
[AUTO] in [Sensitivity]	30cm (1') to 13.5m (44')*1	1.0m (3'3") to 13.5m (44')*1

*1 When the [ISO Limit Set] (P131) is set to [AUTO].

■ Shutter speed for each flash setting

Flash mode	Shutter speed (Sec.)	Flash mode	Shutter speed (Sec.)
⚡A	1/60*2 to 1/4000	⚡S⊙	1*2 to 1/4000
⚡A⊙			
⚡			

*2 When [Sensitivity] is set to [AUTO]. The shutter speed may vary depending on the [ISO Limit Set] setting.

- In Snapshot mode, the shutter speed changes depending on the identified scene.
- In Scene Mode, the shutter speeds will differ from those described above.

📌 Notes

- When using the flash, white saturation can occur if the subject is too close. If [Highlight] in the [Setup] menu is set to [ON], regions with white saturation will flash black and white when you play back or use Auto Review. In this case, we recommend that you adjust [Flash Adjust.] (P138) in the minus direction and take the pictures again.
- Do not use the flash too close to objects or close it while it is firing. The objects may be discolored by its heat or illumination.
- Do not close the flash immediately after it is fired the first time prior to taking pictures with AUTO/Red-Eye Reduction etc. It causes a malfunction.
- Recording a subject from too close, or without sufficient flash illumination will not provide the appropriate level of exposure, and may result in a picture that is too bright or dark.
- When the flash is being charged, the flash icon flashes red, and you cannot take a picture even when you press the shutter release button fully.
- If recording a subject without sufficient flash illumination, the White Balance may not be properly adjusted.
- The flash effect may not be sufficient when shutter speed is fast.
- Flash recharging may take some time after a succession of flash shots. Take a picture after the access indication disappears.
- The Red-Eye Reduction effect differs between people. Also, if the subject was far away from the camera or was not looking at the first flash, the effect may not be evident.

Exposure Compensation

Applicable modes: **A** **P** **A** **S** **M** **C1** **C2** **SCN** **COL**

Use this function to adjust the exposure to the important part of the subject in case of large differences in brightness within the frame.

1 Press the setting wheel to set Exposure Compensation to a selected state.

(A) Exposure Compensation value

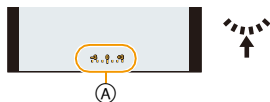

2 Rotate the setting wheel to select the compensation value.

(B) Shutter speed/aperture combination

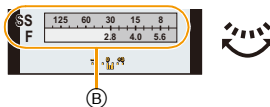

Underexposed



Properly exposed



Overexposed



Compensate the exposure towards positive.

Compensate the exposure towards negative.

Notes

- Set the value to [0] when you do not wish to compensate the exposure.
- The set compensation value is memorized even if the camera is turned off.
- The compensation range may be limited depending on the brightness of the subject.



Continuous Mode

Applicable modes: **[A]** **[P]** **[A]** **[S]** **[M]** <MEM> **[C1]** **[C2]** **[SCN]** **[COL]**

With this mode, pictures are taken as long as the shutter release button is pressed.
The frame rate/frequency can be selected to match the recording conditions or subjects.

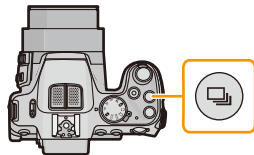







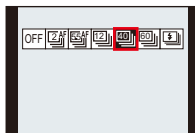



1 Press .



2 Press   to select the frame rate and then **[MENU/SET]**.

- A description of the recording conditions suitable for each frame rate is displayed by pressing **[DISP.]**.



Frame rate (pictures/second)		Features	Maximum recordable pictures
 / 	2	<ul style="list-style-type: none"> When [] or [] is set, the focus is fixed to that for the first picture. When [] or [] is set, the focus is adjusted for each picture. Exposure and White Balance are adjusted for each picture. 	100*1
 / 	5.5		
	12	<ul style="list-style-type: none"> Focus, exposure and White Balance are fixed to those for the first picture. 	12*2
 *3	40	<ul style="list-style-type: none"> Focus, exposure and White Balance are fixed to those for the first picture. Pictures taken with Continuous Mode will be recorded as a single picture group. The range that can be recorded will become smaller when it is set to []. 	40
 *3	60		60
 *4	—	<ul style="list-style-type: none"> A series of pictures are taken with flash. Settings for focus, exposure, shutter speed, ISO sensitivity, and flash output are fixed to those for the first picture. 	5

*1 The number of serially taken pictures is limited by the picture-taking conditions and the type and/or status of the card used.

*2 If [Quality] is set to [RAW*Hi*], [RAW*Lo*] or [RAW], the maximum number of recordable pictures is 11.

*3 This item cannot be set in the Snapshot Mode.

*4 This option is available only in Program Mode, Aperture-Priority Mode or Shutter Priority mode.

Notes

- When [4:3], [3:2] or [16:9] is selected, the resolution setting will become as shown below.

Aspect ratio	[4:3]	[3:2]	[16:9]
[4:3]	[5M], [3M], [2M], [0.3M]	[2.5M], [0.3M]	[3M]
[3:2]	[4.5M], [2.5M], [0.3M]	[3M], [0.3M]	[2.5M]
[16:9]	[3.5M], [2M], [0.2M]	[3.5M], [0.2M]	[2M]
[1:1]	[3.5M], [2.5M], [0.2M]	[2M], [0.2M]	[2.5M]

- When [4:3], [3:2] or [16:9] is selected, [Quality] can only be set to [FINE] or [L.S.].
- The electronic shutter is used when [4:3] or [3:2] is selected, so the recorded picture may appear distorted.
- When the self-timer is used, the number of recordable pictures in Continuous mode is fixed to 3. (5 pictures in [1:1])
- The frame rate (pictures/second) may become slower depending on the recording environment such as in dark places, if the ISO sensitivity is high etc.
- Continuous Mode is not canceled when the camera is switched off.
- The flash setting is fixed to [ON] (except for [1:1]).**
- When using AF Lock, the camera does not adjust the focus for each picture even if you use the setting [AF-LOCK] or [AF-LOCK].
- Continuous mode cannot be used in the following cases.
 - When the self-timer is set to [10s / 3pictures]
 - [Toy Effect]/[Miniature Effect]/[Soft Focus]/[Star Filter] (Creative Control Mode)
 - [Panorama Shot]/[Handheld Night Shot]/[HDR]/[3D Photo Mode] (Scene Mode)
- The zoom cannot be used when recording a series of continuous pictures.
- Depending on the operating conditions, it may take time to take the next picture if you repeat taking a picture.
- It may take time to save pictures taken in Continuous mode on the card. If you take pictures continuously while saving, the maximum number of recordable pictures decreases. For continuous shooting, use of a high speed memory card is recommended.**
- When [AF-LOCK] or [AF-LOCK] is set, focus prediction will be performed in a possible range to prioritize the frame rate. Therefore, if you try to take a picture of a subject that is moving fast, it may have trouble with focusing or it may take time to focus.
- When [4:3], [3:2] or [16:9] is set, the recording may be brighter or darker from the second picture depending on changes in the brightness of the subject.

Using the Self-Timer

Applicable modes: **A** **P** **A** **S** **M** **C1** **C2** **SCN** **COL**

1 Press **▼** [**☺**].

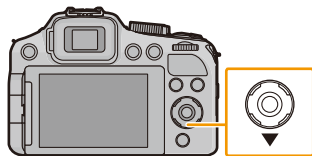

2 Press **▲/▼** to select the item and then [**MENU/SET**].

Item	Description of settings
[10sec.]	The picture is taken 10 seconds after the shutter release button is pressed.
[10s / 3pictures]	10 seconds after the shutter release button is pressed, the camera takes 3 pictures at about 2 second intervals.
[2sec.]	The picture is taken 2 seconds after the shutter release button is pressed. • This setting is a convenient way to avoid the effects of camera shake caused by pressing the shutter release button, e.g. when using a tripod.
[Off]	—

3 Press the shutter release button halfway to focus and then fully to take the picture.

- The Self-timer indicator (A) flashes and the shutter is tripped after 10 seconds (or 2 seconds).
- When [10s / 3pictures] is selected, the self-timer indicator flashes again after the first and the second pictures are taken and the shutter is tripped 2 seconds after it flashes.

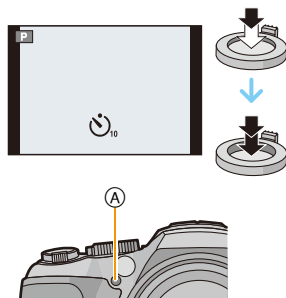

 **Notes**

- When you press the shutter release button once fully, the subject is automatically focused just before recording. In dark places, the self-timer indicator will flash and then may switch to glowing continuously and brightly as an AF Assist Lamp to allow the camera to focus on the subject.
- We recommend using a tripod when recording with the self-timer.
- Depending on the recording conditions, the interval between the exposures may become longer than 2 seconds when [10s / 3pictures] is selected.
- It is not possible to set [10s / 3pictures] in the following cases.
 - Snapshot Mode
 - When using Auto Bracketing
 - When using White Balance Bracketing
 - During Continuous Mode
 - [Panorama Shot] (Scene Mode)
- Setting of the self-timer cannot be performed in following conditions.
 - [3D Photo Mode] (Scene Mode)
 - When recording motion pictures

Setting the Sensitivity

Applicable modes: **A** **P** **A** **S** **M** **M** **C1** **C2** **SCN** **COL**

This allows the sensitivity to light (ISO sensitivity) to be set. Higher values allow using faster shutter speeds and/or higher aperture values or unblurred hand-held shots.

1 Press **▲** [ISO].

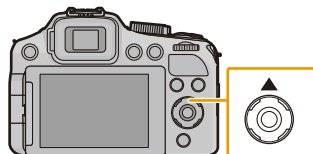

2 Press **▲/▼** to select the ISO sensitivity and then **[MENU/SET]** to set.

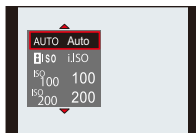

Settings	Description of settings
AUTO	The ISO sensitivity is automatically adjusted according to the brightness. • Maximum [1600] ^{*1}
[ISO]	The ISO sensitivity is adjusted according to the movement of the subject and the brightness. • Maximum [1600] ^{*1}
100/200/400/800/1600/3200/H6400 ^{*2}	The ISO sensitivity is fixed to various settings. • When the [ISO Increments] in [Rec] menu (P131) is set to [1/3 EV], items of ISO sensitivity that can be set will increase.

	[100] ←	→ [6400] ^{*2}
Recording location (recommended)	When it is light (outdoors)	When it is dark
Shutter speed	Slow	Fast
Noise	Less	Increased
Blurred pictures due to camera shake and/or moving subjects	Increased	Less

*1 When the [ISO Limit Set] of [Rec] menu (P131) is set to anything except [AUTO], it is set automatically within the value set in [ISO Limit Set].

*2 Only available when [Extended ISO] (P131) is set.

■ About [ISO] (Intelligent ISO sensitivity control)

The camera detects movement of the subject and then automatically sets the optimum ISO sensitivity and shutter speed to suit the movement of the subject and brightness of the scene to minimize the blurred rendition of the subject.

- The shutter speed is not fixed when the shutter release button is pressed halfway. It will continuously change to match the movement of the subject until the shutter release button is pressed fully.

📌 Notes

- For the flash range when [AUTO] is set, refer to P75.
- The setting is fixed to [AUTO] in the following cases.
 - Creative Control Mode
- The setting is fixed to [ISO] in the following cases.
 - [Sports]/[Baby1]/[Baby2]/[Pet] (Scene Mode)
- You cannot select [ISO] in Shutter-Priority mode.
- You cannot select [AUTO] or [ISO] in manual exposure mode.
- Setting items below will be selectable in Creative Video Mode.
 - [AUTO]/[100]/[200]/[400]/[800]/[1600]/[3200]/[6400]
- The shutter speed is determined by the [Sensitivity] setting as shown in the table below.

[Sensitivity] (When the [ISO Increments] (P131) is set to [1/3 EV])	Shutter speed (Sec.)
AUTO/[ISO]	The shutter speed changes automatically according to ISO sensitivity setting.
100/125/160/200/250/320/400/500/640/800/ 1000/1250/1600	60 to $\frac{1}{4000}$
2000/2500/3200	15 to $\frac{1}{4000}$
H4000*/H5000*/H6400*	8 to $\frac{1}{4000}$

* Only available when [Extended ISO] is set.

Setting the White Balance

Applicable modes: [A] [P] [A] [S] [M] [M] [C1] [C2] [SCN] [COL]

In sunlight, under incandescent lights or in other such conditions where the color of white takes on a reddish or bluish tinge, this item allows adjusting the rendition to the color of white which is closest to what is seen by the eye in accordance with the light source.

1 Press **▶** (WB).

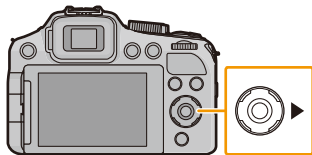

2 Press **▲/▼** to select the White Balance and then **[MENU/SET]**.

Settings	Description of settings
[AWB]	Automatic adjustment
[☀]	For taking pictures outdoors under a clear sky
[☁]	For taking pictures outdoors under a cloudy sky
[🌳]	For taking pictures outdoors in the shade
[🔆]	For taking pictures in which the flash supplies the illumination exclusively
[☹]	For taking pictures under incandescent lights
[📏]/[📏]	For pre-setting a metered White Balance value
[🌡]	For pre-setting a color temperature value

Notes

- Under fluorescent lighting, LED lighting etc., the appropriate White Balance will vary depending on the lighting type, so use [AWB] or [📏]/[📏].
- When using the flash, the White Balance may not be correct for subjects beyond the flash range.
- The White Balance setting is memorized even if the camera is turned off. (However, the White Balance setting for a Scene Mode returns to [AWB] when the Scene Mode is changed.)
- White Balance is fixed to [AWB] in following conditions.
 - [Scenery]/[Panning]/[Night Portrait]/[Night Scenery]/[Handheld Night Shot]/[Food]/[Sunset] (Scene Mode)

■ Auto White Balance

Depending on the conditions prevailing when pictures are taken, they may take on a reddish or bluish tint. Furthermore, when several different types of light sources are being used or there is nothing within the subject with a color close to white, Auto White Balance may not function properly. In a case like this, set the White Balance to a mode other than [AWB].

- 1 Auto White Balance will work within this range.
 - 2 Blue sky
 - 3 Cloudy sky (Rain)
 - 4 Shade
 - 5 Sunlight
 - 6 White fluorescent light
 - 7 Incandescent light (bulbs)
 - 8 Sunrise and sunset
 - 9 Candlelight
- K=Kelvin color temperature

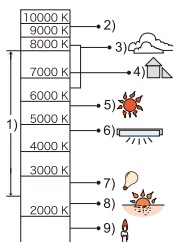

Setting the White Balance manually

For setting the White Balance by metering.

- 1 Select [] or [] and then press **▶**.
- 2 Aim the camera at a sheet of white paper etc. so that the frame in the center is filled by the white object only and then press [MENU/SET].

- The White Balance may not be set when the subject is too bright or too dark. Set it again after adjusting to an appropriate brightness.

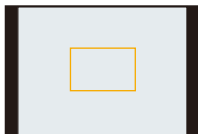

Setting the color temperature

You can set the color temperature manually, e.g. if the color temperature of the light source is known. The light color is defined as a number in degrees Kelvin. As the color temperature increases, the picture becomes more bluish, as it decreases, the picture becomes more reddish.

- 1 Select [] and then press **▶**.
- 2 Press **▲/▼** to select the color temperature and then [MENU/SET].

- You can set a color temperature from [2500K] to [10000K].

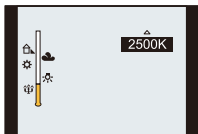

Finely adjusting the White Balance

You can finely adjust the White Balance when you cannot acquire the desired hue with the setting options described above.

1 Select White Balance and then press ►.

- Press ► again if [1], [2] or [K] is selected.

2 Press ▲/▼/◀/▶ to adjust the White Balance and then [MENU/SET].

- ◀: A (AMBER: ORANGE)
- ▶: B (BLUE: BLUISH)
- ▲: G+ (GREEN: GREENISH)
- ▼: M- (MAGENTA: REDDISH)

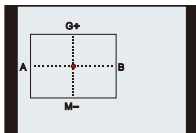

Notes

- If you finely adjust the White Balance to A (amber), the White Balance icon on the screen will change to orange. If you finely adjust the White Balance to B (blue), the White Balance icon on the screen will change to blue.
- If you finely adjust the White Balance to G+ (green) or M- (magenta), [+] (green) or [-] (magenta) appears beside the White Balance icon on the screen.
- Select the central point if you do not want a fine adjustment.
- The White Balance fine adjustment setting is reflected in the picture when using the flash.
- You can finely adjust the White Balance independently for each White Balance item.
- The White Balance fine adjustment setting is memorized even if the camera is turned off.
- The White Balance fine adjustment level returns to the standard setting (central point) in the following cases.
 - When you reset the White Balance in [1] or [2]
 - When you reset the color temperature manually in [K]

White Balance Bracketing

Bracket setting is performed based on the adjustment values for the White Balance fine adjustment, and 3 pictures with different color rendition are automatically recorded when the shutter release button is pressed once.

- 1 Press [DISP.] in step 2 of the “Finely adjusting the White Balance” procedure, and ▲/▼/◀/▶ to set the bracket.

◀/▶: Horizontal (A to B)

▲/▼: Vertical (G+ to M-)

- 2 Press [MENU/SET].

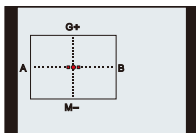

Notes

- [BKT] is displayed on the screen when it is set.
- The White Balance Bracketing setting is erased when the camera is turned off (including Sleep Mode).
- You will only hear the shutter sound once.
- White Balance Bracketing does not work when recording motion pictures.
- White Balance Bracketing cannot be set when the [Quality] is set to [RAW $\frac{1}{2}$], [RAW $\frac{1}{4}$], or [RAW].

Using Auto Focus

Applicable modes:

This mode allows selecting the focusing method that suits the positions and number of the subjects to be selected.

1 Set the focus selector switch to [AF].

2 Press ◀ ().

3 Press ▲/▼ to select the Auto Focus Mode and then [MENU/SET].

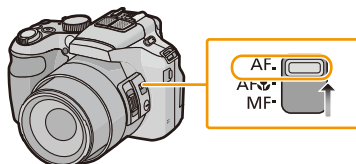

Settings	Description of settings
([Face Detection])	The camera automatically detects the person's face. Focus and exposure are then set based on that face no matter what section of the picture it is in. (max. 15 areas)
([AF Tracking])*	Focus and exposure are locked onto a specified subject. The focus setting will keep on following the subject even if it moves. (Dynamic tracking)
([23-Area])*	Focusing is based on the closest registered object by metering in 23 areas. This mode can be useful when the subject is not in the center of the screen. (AF frame will be same as image aspect ratio setting.)
([1-Area])	The camera focuses on the subject within the AF frame in the center of the screen.

* will be used during motion picture recording.

Notes

- The AF mode will be fixed to when [Face Recog.] is set to [ON].
- It is not possible to set in the following cases.
 - [Panorama Shot]/[Panning]/[Night Scenery]/[Handheld Night Shot]/[Food] (Scene Mode)
 - [Soft Focus] (Creative Control Mode)
- It is not possible to set in the following cases.
 - [Panorama Shot] (Scene Mode)
 - [Sepia]/[Dynamic Monochrome]/[High Dynamic]/[Toy Effect]/[Soft Focus] (Creative Control Mode)
 - When [Photo Style] is set to [Monochrome]
- Only or can be set during Creative Video Mode.
- [AF Mode] is fixed to in the following cases.
 - [Miniature Effect] (Creative Control Mode)
 - [High Speed Video] (Creative Video Mode)

■ About [👤] ([Face Detection])

The following AF frames are displayed when the camera detects the faces.

Yellow:

When the shutter release button is pressed halfway, the frame turns green when the camera is focused.

White:

Displayed when more than one face is detected. Other faces that are the same distance away as faces within the yellow AF frames are also focused.



📘 Notes

- When [Metering Mode] is set to [☐], the camera will adjust the exposure to suit the person's face.
- Under certain picture-taking conditions including the following cases, the face detection function may fail to work, making it impossible to detect faces. [AF Mode] is switched to [☐] ([☐]) while motion pictures are taken.
 - When the face is not facing the camera
 - When the face is at an angle
 - When the face is extremely bright or dark
 - When there is little contrast on the faces
 - When the facial features are hidden behind sunglasses, etc.
 - When the face appears small on the screen
 - When there is rapid movement
 - When the subject is other than a human being
 - When the camera is shaking
 - When Digital Zoom is used
- If the camera is registering something other than someone's face, change the settings to a different mode than [👤].

■ Setting up [AF-ON] ([AF Tracking])

Aim the AF tracking frame at the subject, and press [AF/AE LOCK] to lock it.

Ⓐ AF tracking frame

- The AF tracking frame will be displayed in yellow when a subject is recognized, and exposure and focus will automatically be adjusted continuously following the subject's movement (Dynamic tracking).
- AF tracking is canceled when [AF/AE LOCK] is pressed again.



📘 Notes

- When the AF lock fails, the AF tracking frame will turn red and then disappear. Perform AF lock again.
- In the following cases, [AF-ON] operates as [AF-ON]:
 - When the subject is not specified
 - When the subject is lost
 - When the AF tracking fails
- The dynamic tracking function may not work in the following cases:
 - When the subject is too small
 - When the recording location is too dark or bright
 - When the subject is moving too fast
 - When the background has the same or similar color as the subject
 - When camera shake is occurring
 - When using the zoom

■ Changing position and size of the AF frame (Only when [] is selected)

If you perform any of the following operations, the screen will switch to the settings menu.

- When [] is selected, press [FOCUS].
- From the menu screen, select [], and press ►.

1 Press ▲/▼/◀/▶ to move the AF frame.

- You can move the frame to any position on the screen except the edges.
- After moving the AF frame, press [DISP.] to return it to the center.

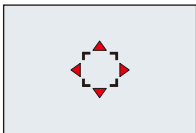

2 Rotate the setting wheel to change the size of the AF frame.

Setting wheel rotated to the right: Enlarges the frame

Setting wheel rotated to the left: Reduces the frame

- It can be changed to 4 different sizes.

3 Press [MENU/SET] to set.

Notes

- The AF frame cannot be moved during motion picture recording.
- The spot metering target can also be moved to match the AF frame when using [].
- The position of the AF frame will return to the initial state when the camera is set to Snapshot Mode, when the Sleep Mode is activated, or when the camera is turned off.
- The AF frame may not be displayed as intended at certain zoom magnifications or under low light.

Close-up Pictures

Applicable modes:

This mode allows you to take close-up pictures, e.g. of flowers. You can take pictures of a subject as close as 1cm / $\frac{3}{8}$ " from the lens with the shortest focal length setting (1× magnification; utmost W position).

Set the focus selector switch to [AF].

• In AF Macro Mode, is displayed.

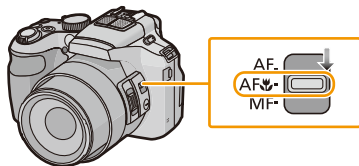

Notes

- We recommend using a tripod and the Self-timer.
- We recommend setting the flash mode to (close the flash) when you take pictures at close range.
- If the distance between the camera and the subject is beyond the focus range of the camera, the picture may not be properly focused even if the focus indication lights up.
- When a subject is close to the camera, the depth of field, i.e. the area rendered sharply is significantly reduced. Therefore, if the distance between the camera and the subject is changed after focusing on the subject, it may become difficult to focus on it again.
- Macro Mode gives priority to a subject close to the camera. Therefore, if the distance between the camera and the subject for a following shot is much greater, it takes longer to focus on it.
- When you take pictures at close range, the resolution of the periphery of the picture may decrease slightly. This is not a malfunction.
- If the lens becomes dirty with fingerprints or dust, it may not be able to focus on the subject correctly.
- It is not possible to set AF Macro Mode in the following cases.
 - In all Scene Modes except [3D Photo Mode]

Manual Focusing

Applicable modes: 

Use this function when you want to fix the focus or when the distance between the lens and the subject is known and you do not want to activate Auto Focus.

1 Set the focus selector switch to [MF].

- When using Manual Focus, [MF] is displayed on the screen.

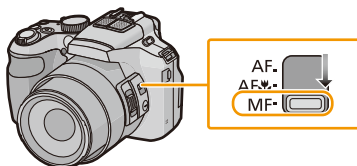

2 Press the setting wheel to set [MF] to a selected state.

- Enabled operation will switch every time the setting wheel is pressed.



3 Rotate the setting wheel to display the focus range on the screen.

4 Press ◀▶ or rotate the setting wheel to focus on the subject.

- Using the cursor buttons is recommended when making slight adjustments.
- When you stop setting the focus, the focus range display will disappear after a few seconds.

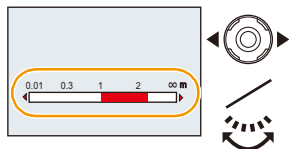

■ Focus setting with the zoom/focus rocker

- Set the focus selector switch to [MF].

1 Set [Side Lever] in the [Setup] menu to [FOCUS]. (P54)

2 Slide the zoom/focus rocker to display the focus range on the screen.

3 Slide the zoom/focus rocker to focus on the subject.

Zoom/focus rocker moved towards (T): Sets longer focal lengths

Zoom/focus rocker moved towards (W): Sets shorter focal lengths

- Using the cursor buttons is recommended when making slight adjustments.

■ MF Assist

If [MF Assist] (P59) in the [Setup] menu is set to [ON], the displayed image is enlarged as soon as focusing is performed.

- If you press [MENU/SET] while the enlarged section is displayed, the area can be moved using ▲/▼/◀/▶. Pressing [MENU/SET] again returns the camera to MF Assist.
- Performing the following operations returns the MF area to the center.
 - Changing the resolution or aspect ratio.
 - Turning the camera off (including Sleep Mode).
- The magnification of the enlarged area can be changed by pressing the setting wheel when MF Assist is activated or the MF area is moving.

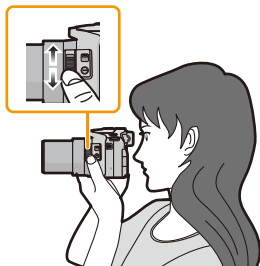

Performing manual focusing

- 1 Focus by rotating the setting wheel.
- 2 Press the cursor button in the same direction (nearer or farther) a few times.
- 3 Finely focus on the subject by pressing the cursor button for the opposite direction.



■ Prefocusing

This is a technique for focusing in advance on the distance the subject will be, when using Auto Focus is difficult due to the subject's quick motion. (e.g. [Panning] in Scene Mode)

This function is suitable when the distance between the camera and the subject is known and remains the same.

■ One shot AF

You can focus on the subject with Auto Focus by pressing the [FOCUS] button during Manual Focus.

This is convenient for prefocusing.

📌 Notes

- If you use the zoom function after focusing on the subject, focus on the subject again.
- MF Assist is disabled in the Digital Zoom range or when recording motion pictures.
- The distance to the subject displayed on the screen in Manual Focus is an approximation of the focus position. Use the MF Assist screen for a final check of the focus.
- After canceling Sleep Mode, focus on the subject again.
- Using MF Assist in combination with AE Lock makes it easy to check the focus.

Focus and Exposure Memory Lock (AF/AE Lock)

Applicable modes: 

This function is useful when you want to take a picture of an off-center subject or when you want to base the exposure on a specific part of the subject in situations with significant brightness differences.

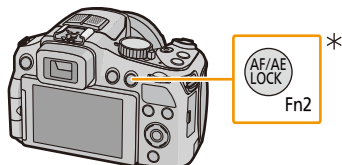

* To use for the [AF/AE LOCK] function, set [AF/AE LOCK /Fn2] in the [Setup] menu to [AF/AE LOCK]. (P54)

- 1 Aim the AF frame at the main subject.**
- 2 Press [AF/AE LOCK] to fix the focus and exposure settings.**
 - This does not work when AF tracking is active.
 - The setting is canceled by pressing the [AF/AE LOCK] button again.
- 3 Move the camera to compose the picture and then press the shutter release button fully.**
 - When [AE] is set, after pressing the shutter release button halfway to focus, press the shutter release button fully.

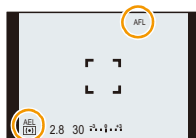

■ AF/AE Lock

Which of the focus and exposure settings you wish to lock can be set in [AF/AE Lock] in the [Rec] menu.

Item	Description of settings
[AF]	Only the focus setting is locked. • [AFL] and focus indication are displayed when the subject comes into focus.
[AE]	Only the exposure setting is locked. • [AEL], aperture value and shutter speed are displayed when the exposure is set.
[AF/AE]	Both focus and exposure settings are locked. • [AFL], [AEL], the focus indication, aperture value and shutter speed are displayed when the focus and the exposure are set.

Notes

- When AE lock is performed, the image brightness on the screen is fixed.
- AF Lock only is only available in Manual Exposure Mode or Scene Mode.
- AE Lock only is only available with Manual Focus.
- AE Lock and AF Lock must be activated before motion picture recording begins.
- When recording motion pictures after locking, you can continue to record in a locked state in Creative Video Mode. The locked settings will be canceled in other modes than Creative Video Mode.
- The locked settings are canceled when zooming is performed after locking. Perform the locking again.
- The exposure setting remains locked, even if the brightness of the subject changes after locking.
- The subject can be focused again by pressing the shutter release button halfway even when the exposure setting is locked.
- Program Shift can be set even when the exposure setting is locked.

Using the function button

You can assign one of a number of functions. to the function buttons. Press the buttons to instantly access the assigned functions.

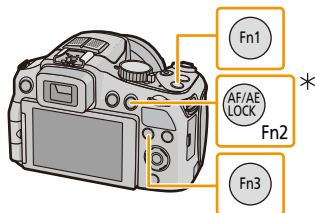

* To use as the function button, set [AF/AE LOCK /Fn2] in the [Setup] menu to [Fn2]. (P54)

- 1** Select [Fn Button Set] in the [Setup] menu. (P49)
- 2** Press ▲/▼ to select the button to assign and then press [MENU/SET].
- 3** Press ▲/▼ to select the function to assign and then press [MENU/SET].

Assignable functions	
[Photo Style] (P127)	[Video Rec Area] (P57)
[Aspect Ratio] (P128)	[Remaining Disp.] (P58)
[Quality] (P130)	[Flash] (P72)
[Metering Mode] (P133)	[Flash Adjust.] (P138)
Focus [AF Style] (P132)	[Auto Bracket] (P139)
[i.Dynamic] (P134)	[Side Lever] (P54)
[Guide Line] (P56)	

- Exit the menu after it is set.

Aperture-Priority Mode

Recording mode: [A] P [A] S M [M] C1 C2 SCN COL

Set the aperture value to a higher number when you want a larger in-focus area (in front of and behind the main subject), to a lower number for a smaller in-focus area.

1 Set the mode dial to [A].

2 Rotate the setting wheel to set the aperture value.

- (A) Aperture Value
- (B) Shutter speed/aperture combination

- The operation mode will switch between aperture and exposure compensation setting every time the setting wheel is pressed.

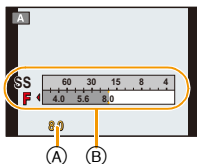

Available Aperture Value* (Per $\frac{1}{3}$ EV)	Shutter Speed* (Sec)
F2.8 to F8.0	8 to $\frac{1}{4000}$

* Depending on the zoom position, some of the values cannot be selected.

Shutter-Priority Mode

Recording mode: **[A]** **P** **A** **[S]** **M** **CM** **C1** **C2** **SCN** **COL**

When you want to take a sharp picture of a fast moving subject, set to a faster shutter speed.
When you want to create a trailing effect, set to a slower shutter speed.

- 1 Set the mode dial to **[S]**.
- 2 Rotate the setting wheel to set the shutter speed.

- (A) Shutter Speed
- (B) Shutter speed/aperture combination

- The operation mode will switch between shutter speed and exposure compensation setting operation every time the setting wheel is pressed.

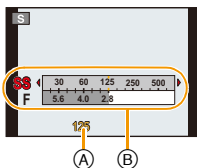

Available Shutter Speed (Sec) (Per $\frac{1}{3}$ EV)	Aperture Value*
8 to $\frac{1}{4000}$	F2.8 to F8.0

* Depending on the zoom position, some of the values cannot be selected.

Manual Exposure Mode

Recording mode: **[M]** P A S **[M]** CM C1 C2 SCN COL

Determine the exposure by manually setting the aperture value and the shutter speed.

- 1 Set the mode dial to **[M]**.
- 2 Rotate the setting wheel to set the aperture and the shutter speed.

- (A) Light balance
- (B) Shutter speed/aperture combination
- The operation mode will switch between aperture and shutter speed setting every time the setting wheel is pressed.

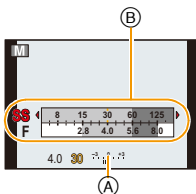

Available Aperture Value* ¹ (Per 1/3EV)	Available Shutter Speed* ¹ (Sec) (Per 1/3EV)
F2.8 to F8.0	60* ² to 1/4000

*¹ Depending on the zoom position, some of the values cannot be selected.

*² The shutter speed varies depending on the [Sensitivity] setting. (P83)

Light balance

	The exposure is appropriate.
	Set to a faster shutter speed and/or a larger aperture value.
	Set to a slower shutter speed and/or a smaller aperture value.

• The Light Balance is an approximation. We recommend checking the pictures on the playback screen.

Notes

- The brightness of the image you see on the screen and the recorded pictures may differ. Check the pictures on the playback screen.
- Set the aperture value to a higher number and/or a faster shutter speed when the subject is too bright, or to a lower number and/or a slower shutter speed if it is too dim.
- The aperture value and the shutter speed displayed on the screen turn red when the exposure is not appropriate.
- The displayed shutter speed will be counted down when the set shutter speed is slow and the shutter release button is pressed all the way.
- We recommend using a tripod with slower shutter speeds.
- [Sensitivity] is automatically set to [AUTO] when you switch the Recording Mode to Shutter-Priority Mode when [Sensitivity] was set to [ISO].
- [Sensitivity] is automatically set to [100] when you switch the Recording Mode to Manual when [Sensitivity] was set to [AUTO] or [ISO].

Using the Scene Modes

Recording mode: [A] [P] [A] [S] [M] [C1] [SCN] [COL]

When you select a Scene Mode to match the subject and recording situation, the camera sets the optimal exposure and hue to obtain the desired picture.

- 1 Set the mode dial to [SCN].
- 2 Press /// to select the Scene Mode and then [MENU/SET].

- If you press [DISP.] when selecting a Scene Mode, explanations about each Scene Mode are displayed.



Note

- To change the Scene Mode, press [MENU/SET] and then , and return to step 2 above.

[Portrait]

When taking pictures of people outdoors during the day, this mode allows you to improve the appearance of these persons and make their skin tones look healthier.

■ Technique for Portrait Mode

To make this mode more effective:

- 1 Use the longest possible focal length (rotate the zoom lever towards T).
- 2 Move close to the subject to make this mode more effective.

[Soft Skin]

When taking pictures of people outdoors during the daytime, this mode enables the texture of their skin to appear even softer than with [Portrait]. (It is effective when taking pictures of people from the chest up.)

■ Technique for Soft Skin Mode

To make this mode more effective:

- 1 Use the longest possible focal length (rotate the zoom lever towards T).
- 2 Move close to the subject to make this mode more effective.



Notes

- If a part of the background etc. is a color similar to skin color, this part is also smoothed.
- This mode may not be effective when there is insufficient brightness.

[Scenery]

This allows you to take pictures of a wide landscape.

[Panorama Shot]

Pictures are recorded continuously while moving the camera horizontally or vertically, and are combined to make a single panorama picture.

- 1 Press **▲/▼** to select the recording direction and then **[MENU/SET]**.
- 2 After confirming the recording direction, press **[MENU/SET]**.
 - The horizontal/vertical guidelines will be displayed.
- 3 Press the shutter release button halfway to focus.
- 4 Press the shutter release button fully and record a picture while moving the camera in a small circle in the direction selected in Step 1.

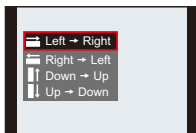

Recording from left to right

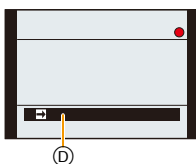
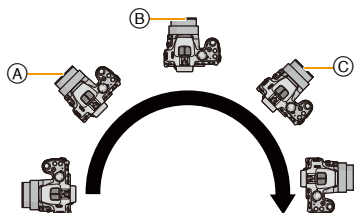

Move the camera in a single panning motion for about 8 seconds.

- Move the camera at a constant speed.

Pictures may not be able to be recorded properly if the camera is moved too fast or too slow.

(A) Position after 1 second

(C) Position after 3 seconds

(B) Position after 2 seconds

(D) Recording direction and panning (Guide)

■ Technique for Panorama Shot Mode

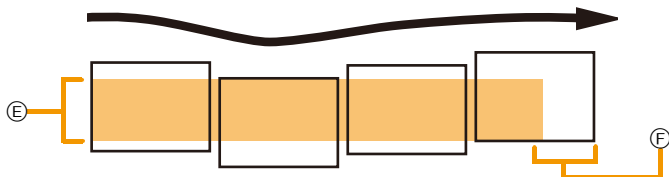

(E) Move the camera in the recording direction without shaking it. If the camera shakes too much, pictures may not be able to be recorded, or the recorded panorama picture may become narrower (smaller)

(F) Move the camera towards the edge of the range you wish to record. (The edge of the range will not be recorded in the last exposure)

- 5 Press the shutter release button again to end the recording.
 - Recording can also be canceled by keeping the camera still while recording.

Notes

- The zoom position is fixed to the shortest focal length.
- The focus, white balance, and exposure settings are fixed at the optimum values for the first picture. As a result, if the distance to the different subjects and/or the brightness changes substantially during recording, the entire panorama picture may not be rendered with suitable focus or brightness.
- When multiple pictures are combined to create a single panorama picture, the subject may appear distorted or the connection points may be noticeable in some cases.
- The number of pixels in the horizontal and vertical directions of the panorama picture varies depending on the recording direction and the number of combined pictures. The maximum number of pixels is shown below.

Recording direction	Horizontal Resolution	Vertical Resolution
Horizontal	8000 pixels	1080 pixels
Vertical	1440 pixels	8000 pixels

- A panorama picture may not be able to be created, or the pictures may not be combined properly when recording the following subjects or under the recording conditions below.
 - Subjects with a single, uniform color or a repetitive pattern (such as the sky or a beach)
 - Moving subjects (persons, pets, cars, waves, flowers blowing in the breeze, etc.)
 - Subjects where the color or patterns change in a short time (such as an image appearing on a display)
 - Dark places
 - Locations with flickering light sources such as fluorescent lights or candles

About playback

Playback zoom can be performed even for pictures that were recorded using [Panorama Shot]. Also, if ▲ is pressed during playback, the screen will automatically scroll in the same direction during recording.

▲	Start/Pause*	
▼	Stop	

- * You can perform frame-by-frame forward/rewind by pressing ►/◀ during a pause.

[Sports]

This mode facilitates taking pictures of sports scenes or other fast-moving events.

Notes

- The shutter speed may slow down to 1 second.
- This mode is suitable for taking pictures of subjects at distances of approx. 5m / 16' 4" or more.

[Panning]

When following a subject moving in one direction such as a runner or a car by turning the camera, the background becomes a blur and the subject stays focused. This effect is called "panning". This mode allows you to obtain this effect easier.

Setting the shutter speed

Select from [Auto] or [Shutter-Priority].

- If you select [Auto], it will not be possible to select the shutter speed.
- If you select [Shutter-Priority], the operating mode will switch between shutter speed and exposure compensation setting every time the setting wheel is pressed.

Technique for Panning Mode

To obtain good pictures in Panning Mode, turn the camera in a horizontal plane as you take the pictures.

- We recommend that you do not follow the subject with the camera alone, but stand facing the subject with shoulders squared, and follow it using your entire body, while twisting at the waist.
 - Once the subject is in front of you, press the shutter release button. Do not stop moving the camera even after that.
- 1 Turn the camera smoothly while following the subject in the viewfinder.
 - 2 Press the shutter release button while you are turning the camera.
 - 3 Turn the camera continuously.
- We recommend the following:
 - Use the viewfinder.
 - Select a subject with quick motion.
 - Use prefocus.
 - Use this mode together with Continuous Mode.
(You can then select the best pictures from all the pictures taken.)

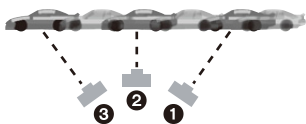

Note

- The shutter speed in Panning Mode becomes slower to achieve the panning effect. As a result, camera shake can easily occur.

[Night Portrait]

This mode allows you to take pictures of a person in which the background is rendered with near real-life brightness.

■ Technique for Night Portrait Mode

- **Use the flash.** (You can set to [].)
- Ask the subject not to move while taking the picture.

Notes

- We recommend using a tripod and the self-timer.
- The shutter speed may slow down to 8 seconds.
- The shutter release button may remain locked (max. about 8 sec.) after taking the picture because of signal processing. This is not a malfunction.
- Noise may become visible when you take pictures in dark places.

[Night Scenery]

This mode allows you to take vivid pictures of nightscapes.

Notes

- We recommend using a tripod and the self-timer.
- The shutter speed may slow down to 8 seconds.
- The shutter release button may remain locked (max. about 8 sec.) after taking the picture because of signal processing. This is not a malfunction.
- Noise may become visible when you take pictures in dark places.

[Handheld Night Shot]

With this mode, a high-frame rate series of pictures is automatically taken and combined to make a single picture. This reduces the effects of camera shake and noise from the picture even with hand-held shooting.

Notes

- Do not move the camera while recording the picture series.
- Noise may become visible when you take pictures in dark places or take pictures of moving subjects.

[HDR]

This mode combines several pictures with different levels of exposure into a single picture with rich gradation. You can minimize the loss of gradations in bright areas and dark areas when the contrast is large.

■ What Is HDR?

HDR stands for High Dynamic Range and refers to a technique for expressing a wide contrast range.

Notes

- Do not move the camera during the continuous shooting after pressing the shutter release button.
- You cannot take the next picture until the combination of pictures is complete.
- A moving subject may be recorded with unnatural blurs.
- The continuous shooting may not work under certain recording conditions. In that case, a single picture is recorded.

[Food]

This mode allows you to take pictures of food with a natural hue without being affected by the ambient light in restaurants etc.

[Baby1]/[Baby2]

In the pictures taken with this mode, babies have a healthy complexion. When you use the flash, the light from it is weaker than usual.

It is possible to set different birthdays and names for [Baby1] and [Baby2]. You can select to have these appear at the time of playback, or have them stamped on the recorded image using [Text Stamp] (P155).

■ Birthday/Name setting

- 1 Press ▲/▼ to select [Age] or [Name] and then ►.
- 2 Press ▲/▼ to select [SET] and then [MENU/SET].
- 3 Enter the birthday or name.

Birthday: ◀/▶: Select the items (year/month/day)

▲/▼: Setting

[MENU/SET]: Set

Name: For details on how to enter characters, refer to "Entering Text" on P126.

- When the birthday or name is set, [Age] or [Name] is automatically set to [ON].
- If [ON] is selected when the birthday or name has not been registered, the setting screen appears automatically.

- 4 Press [MENU/SET] to finish.

■ Canceling [Age] and [Name]

Select the [OFF] setting in step 2.

📌 Notes

- Still pictures recorded during motion picture recording will not record age or name.
- If [Age] or [Name] is set to [OFF] even when the birthday or name has been set, the age or name will not be displayed.
- The shutter speed may slow down to 1 second.

[Pet]

Select this mode when you want to take pictures of a pet such as a dog or a cat. You can set your pet's birthday and name.

For information about [Age] or [Name], refer to [Baby1]/[Baby2] on [P109](#).

[Sunset]

Select this mode when you want to take pictures of a sunset view. This allows you to take vivid pictures of the red color of the sun.

[High Sens.]

This mode minimizes blurring due to moving subjects, and enables you to take pictures of these subjects in dimly lit rooms.

■ Resolution and aspect ratio

Select a resolution of 3M (4:3), 2.5M (3:2), 2M (16:9) or 2.5M (1:1).

[Glass Through]

This mode is ideal for taking pictures of scenery and other landscapes through windows, such as in vehicles or buildings.



Notes

- The camera may focus on the glass if it is dirty or has dust on it.
- The pictures taken may not look natural if the glass is colored. When this happens, change the white balance settings. ([P84](#))

[3D Photo Mode]

With this mode, pictures are recorded continuously while moving the camera horizontally, and two pictures selected automatically are combined to make a single 3D picture. To view 3D pictures, a television that supports 3D is required. (This camera will play back in 2D) Refer to P171 for details about the playback method.

■ Technique for 3D Photo Mode

Start the recording and then move the camera horizontally straight from left to right.

- A guide is displayed while recording.
- Move the camera approximately 10cm / 4" within approximately 4 seconds using the guide.

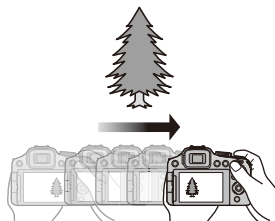

■ To avoid mistakes in 3D recording

- Take the picture of a subject that is not moving.
- Take the picture in a well-lit place, such as outdoors, etc.
- Fix the focus and exposure by pressing the shutter release button halfway, then press it fully and move the camera.
- When you start recording with the subject slightly to the right of the center, the subject will be close to the center in the final picture.

📘 Notes

- **You cannot record 3D pictures in vertical orientation.**
- The 3D pictures are saved in MPO format (3D).
- The zoom position is fixed to the shortest focal length.
- The resolution is fixed to 2M (16:9).
- The ISO sensitivity is automatically adjusted. However, the ISO sensitivity is increased to ensure sufficiently fast shutter speeds.
- Motion pictures cannot be recorded during 3D Photo Mode.
- Recording may not be possible depending on the recording conditions for the following cases. You may not get a 3D effect or the picture may be distorted even if it was possible to record.
 - When the subject is too dark/bright
 - When the brightness of the subject changes
 - When the subject is moving
 - When the subject does not have enough contrast

Using the different image effects

(Creative Control Mode)

Recording mode: [A] P A S M [M] C1 C2 SCL [COL]

This mode allows you to utilize different image effects. You can set the effects to add by selecting example images and check the resulting image on the screen.

1 Set the mode dial to [COL].

2 Press ▲/▼ to select image effects (filters) and then [MENU/SET].

- The image effect of the selected example image will be applied in a preview display (A).
- A brief description of selected image effect appears when you press [DISP].

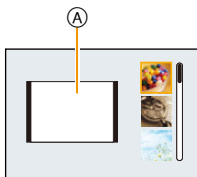

■ Adjust the effect to fit your preferences.

The strength and colors of the effects can be easily adjusted to fit your preferences.

1 Press the setting wheel to display the options.

2 Press ▲/▼ to select the item

[]: Adjust the brightness.

[]: Adjust the background blur.

[]: Adjust the image effect.

- The items that can be set differ depending on which Creative Control Mode is currently set.

For information on each image effect, refer to "Items that can be set".

3 Press ◀/▶ or rotate the setting wheel to adjust.

- Press [/↶] to reset the setting to the default state (AUTO).
- To adjust automatically, reset the setting to the default state (AUTO).

4 Press [MENU/SET] or the setting wheel to set.

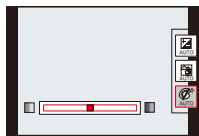

📌 Notes

- The displayed image on the screen and the preview of the selected image effect may differ from the actual recorded image.
- Creative Control settings are memorized even if the camera is turned off.
- White Balance will be fixed to [AWB], and [Sensitivity] will be fixed to [AUTO].
- In [Miniature Effect] of Creative Control Mode, Defocus Control cannot be used.

* These pictures are examples to show the effect.

[Expressive]



This effect emphasizes the color to make a pop art picture.

Items that can be set

Freshness	Understated colors	↔	Pop colors
-----------	--------------------	---	------------

[Retro]



This effect gives a faded image.

Items that can be set

Color	Yellow is emphasized	↔	Red is emphasized
-------	----------------------	---	-------------------

[High Key]



This effect adds a bright, airy and soft feel to the overall image.

Items that can be set

Color	Pink is emphasized	↔	Aquamarine is emphasized
-------	--------------------	---	--------------------------

[Low Key]

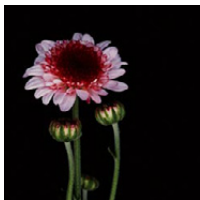

This effect adds a dark and relaxing feel to the overall image and enhances bright parts.

Items that can be set

Color	Red is emphasized	↔	Blue is emphasized
-------	-------------------	---	--------------------

[Sepia]

This effect creates a sepia image.

Items that can be set

Contrast	Low	↔	High
----------	-----	---	------

[Dynamic Monochrome]

This effect gives a higher contrast to create an impressive black and white picture.

Items that can be set

Contrast	Low	↔	High
----------	-----	---	------

[Impressive Art]

This effect gives your photo a dramatic contrast look.

Items that can be set

Freshness	Black and white	↔	Pop colors
-----------	-----------------	---	------------

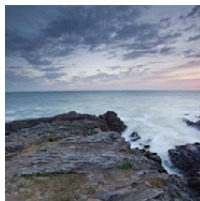
[High Dynamic]

This effect produces the optimum brightness for both dark and bright areas of the image.

Items that can be set

Freshness	Black and white	↔	Pop colors
-----------	-----------------	---	------------

[Cross Process]

This effect gives your photo a dramatic color look.

Items that can be set

Color	Green tone/Blue tone/Yellow tone/ Red tone
-------	---

- Select the color to enhance, and press [MENU/SET].

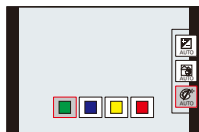
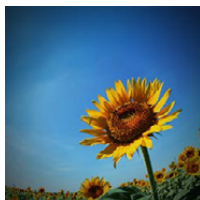
**[Toy Effect]**

This effect reduces peripheral brightness to give the impression of a toy camera.

Items that can be set

Color	Orange is emphasized	↔	Blue is emphasized
-------	----------------------	---	--------------------

[Miniature Effect]

This effect blurs peripheral areas to give the impression of a diorama.

Items that can be set

Freshness	Understated colors	↔	Pop colors
-----------	--------------------	---	------------

■ Setting the type of defocus

With [Miniature Effect] you can make the subject stand out by determining the defocused and in-focus areas. You can set the (defocus) orientation and the position and size of the in-focus area.

1 Press [Fn3] to display the setting screen.

- A frame around the area not to be blurred will be displayed.

2 Adjust the position and size of the frame and then press [MENU/SET] to set.

	(A) When the frame is horizontal	(B) When the frame is vertical
▲/▼	Moves (up and down)	Switches to (A)
◀/▶	Switches to (B)	Moves (left and right)
	Enlarge and reduce • You can switch between three levels.	
• If you press [DISP.], the adjusted frame will return to the original values.		

(C) Non-blurrable area

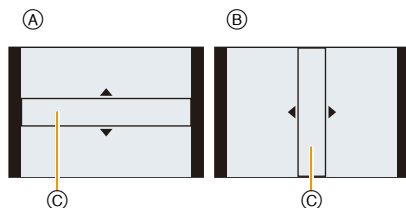

📌 Notes

- The monitor image refresh rate is reduced, which may cause the displayed image to change less smoothly.
- No sound is recorded in motion pictures.
- When taking pictures with high resolution, the screen may turn black after taking the picture because of signal processing. This is not a malfunction.
- **With camera model 18 190:**
Approximately $\frac{1}{8}$ of the time period is recorded. (If you record for 8 minutes, the resulting motion picture recording will be approximately 1 minute long.)
The displayed available recording time is approximately 8 times. When switching between recording modes, please check the available recording time.
- **With camera models 18 191 / 18 192:**
Approximately $\frac{1}{10}$ of the time period is recorded. (If you record for 10 minutes, the resulting motion picture recording will be approximately 1 minute long.)
The displayed available recording time is approximately 10 times. When switching between recording modes, please check the available recording time.

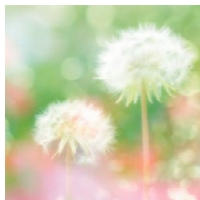
[Soft Focus]

This effect blurs the overall image to produce a soft impression.

Items that can be set

Defocus effect	Weak	↔	Strong
----------------	------	---	--------

 **Note**

- The display of the recording screen will be delayed more than usual.

[Star Filter]

This effect transforms pin-points of light into a star effect.

Items that can be set

Length of the rays	Short	↔	Long
--------------------	-------	---	------

 **Note**

- The display of the recording screen will be delayed more than usual and the screen will look as if frames are dropping.

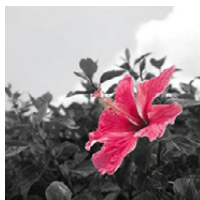
[One Point Color]

This effect leaves one selected color to emphasize impressiveness.

Items that can be set

Amount of color left	Small	↔	Large
----------------------	-------	---	-------

 **Set the color to retain**

Set the color to retain by selecting its occurrence on the screen.

- 1 Press [Fn3] to display the setting screen.**
- 2 Aim the center frame at the color you want to retain, and press [MENU/SET].**

 **Note**

- Depending on the subject, the set color may not be retained.

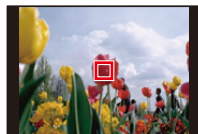

Recording Motion Pictures with Manual Settings

(Creative Video Mode)

Recording mode: [A] [P] [A] [S] [M] [MM] [C1] [C2] [SCN] [COL]

It is possible to manually change the aperture and shutter speed when recording motion pictures.

Switching the [Creative Video] setting allows you to use settings such as those when the mode dial is switched to [P], [A], [S] and [M].

- 1 Set the mode dial to [MM].
- 2 Press ▲/▼ to select the item and then [MENU/SET].
- 3 Rotate the setting wheel to change the settings.

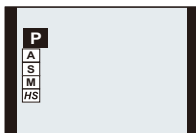

Item	Items that can be set will switch every time the setting wheel is pressed	
P	—	Exposure Compensation
A	Aperture (F2.8 to F11)	Exposure Compensation
S	Shutter speed (Sec.) ($1/30$ to $1/20000$)* ¹	Exposure Compensation
M	Shutter speed (Sec.) ($1/30$ to $1/20000$)* ¹ (When using Manual Focus, the shutter speed can be set from $1/8$ to $1/20000$.* ²)	Aperture (F2.8 to F11)
HS [High Speed Video] (P119)	—	Exposure Compensation

*¹ If you record with the shutter speed set to slower than $1/50$ s*³($1/60$ s*⁴) and [Rec Mode] set to [AVCHD], the exposure time per frame will increase. Depending on the movement of the subject, this may result in blurring in the frames.

*² During recording, if you set the focusing mode to anything but Manual Focus with the shutter speed set to slower than $1/30$ s, the shutter speed will automatically be set to $1/30$ s.

*³ With camera model 18 190

*⁴ With camera models 18 191 / 18 192

 **Notes**

- The settings of the aperture value, shutter speed and exposure compensation can be changed during motion picture recording. In this case, care must be taken because the sounds of such operations may be recorded.
- Manually setting a higher shutter speed may increase the noise on-screen due to the higher sensitivity.
- When recording under lighting such as fluorescent, LED, mercury and sodium lighting, the color rendition and brightness of the screen may change.
- Refer to "Recording Motion Pictures" on P38 for other settings and operations for recording motion pictures.

Recording High Speed Motion Pictures

Using the [**HS**](High Speed Video) mode, you can record very fast movements that cannot be discerned by the naked eye at the rate of up to 200*1(240*2) frames/second.

*1 With camera model 18 190

*2 With camera models 18 191 / 18 192

- Motion pictures are recorded in [MP4].

- 1 Set the mode dial to [**M**].**
- 2 Press ▲/▼ to select [**HS**] and then [MENU/SET].**
- 3 Press ▲/▼ to select the picture quality and then [MENU/SET].**
 - You can also select the recording quality from [High Speed Video] (P143) in the [Motion Picture] menu.

 **Notes**

- **Pictures created with this mode cannot be recorded into the internal memory.**
- Audio is not recorded.
- Motion pictures can be recorded continuously for up to 4GB.
- The camera can record motion pictures for up to 29 minutes in playback time equivalent.
- The focus, zoom, exposure and White Balance settings are fixed to the values at the beginning of the motion picture recording.
- Under fluorescent lighting, flickering or horizontal bars may be seen.

Using Custom Mode

Recording modes: [A] P A S M [C1] [C2] SCN COL

You can register the current camera settings as custom settings. If you then record in Custom Mode, you can use the registered settings.

- The initial setting of the Program Mode is registered as the custom settings initially.

■ Example of registering the settings of the recording mode [P] and menus etc. to [C1]:



1 Make the settings

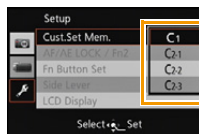

2 Register them

Even if you change the settings.

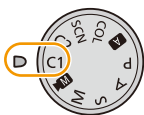

3 Set to Custom Mode

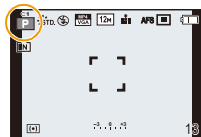

4 Settings registered in Step 2 are called up

Registering Personal Menu Settings (Registering custom settings)

If you want to repeatedly take pictures with the same settings, you can register up to four items of the current camera settings to [Cust.Set Mem.].

- 1 **Set the mode dial to select the mode you wish to save, and then set the menu on the camera.**
- 2 **Select [Cust.Set Mem.] in the [Setup] menu. (P49)**
- 3 **Press ▲/▼ to select the custom set to register and then [MENU/SET].**

- A confirmation screen is displayed. It is executed when [Yes] is selected.
Exit the menu after it is executed.

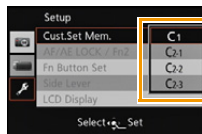

Recording using registered custom settings

You can easily call up the settings you have registered using [Cust.Set Mem.].

Set the mode dial to [C1] or [C2].

Ⓐ Custom setting display

- When the mode dial is set to [C2], press ▲/▼ to select the custom set and then [MENU/SET].

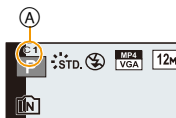

■ To change the menu settings

When the recording mode is set to [C1] or [C2], registered settings do not change even if you change the menu settings temporarily.

You can change the registered settings from [Cust.Set Mem.] in the [Setup] menu.

Note

- Since certain menu items would be reflected in other recording modes, they are not saved.

Using the Face Recognition Function

Applicable modes: **[A]** **[P]** **[A]** **[S]** **[M]** **[C1]** **[C2]** **[SCN]** **[COL]**

Face Recognition is a function which finds a registered face and automatically bases focus and exposure on it. Even if the person is located towards the back or on the end of a line in a group photo, the camera can still take an in-focus picture of that person.

[Face Recog.] is initially set to [OFF] on the camera.

[Face Recog.] will turn [ON] automatically when the camera detects a registered face.

- The following functions will also work with the Face Recognition function.

In Recording Mode

- The display of the corresponding name when the camera detects a registered face* (if the name has been set for the registered face)

In Playback Mode

- The display of name and age (if the information has been registered)
- Selective playback of pictures chosen from pictures registered with Face Recognition ([Category Selection] in [Filtering Play]).

- * Names of up to 3 persons are displayed. Precedence for the names displayed when taking pictures is determined according to the order of registration.



Notes

- With Continuous Mode, [Face Recog.] picture information can be attached to only the first picture.
- [Face Recog.] does not guarantee secure recognition of a person.
- Face Recognition may take more time to select and recognize distinctive facial features than regular face detection.
- Even when Face Recognition information has been registered, pictures taken with [Name] set to [OFF] will not be categorized by Face Recognition in [Category Selection] ([Filtering Play]).
- **Even when Face Recognition information is changed (P125), Face Recognition information for the pictures already taken will not be changed.**
For instance, if the name is changed, pictures recorded before the change will not be categorized by Face Recognition in [Category Selection] ([Filtering Play]).
- To change the name information of the pictures taken, perform the [REPLACE] in [Face Rec Edit] (P165).
- [Face Recog.] cannot be used in the following cases.
 - Recording modes which do not allow setting to **[Face Recog.]** in [AF Mode]
 - [3D Photo Mode] (Scene Mode)
 - When using Manual Focus
 - When recording motion pictures

Face Settings

You can register information such as names and birthdays for faces of up to 6 people. Registration can be facilitated by taking multiple face images of each person. (up to 3 pictures/registration)

■ Point of recording when registering the face images

- The subject should face the camera with eyes open and mouth closed, making sure the outline of the face, the eyes, or the eyebrows are not covered by the hair when registering.
- Make sure there is no extreme shading on the face when registering. (Flash will not fire during registration.)

(Good example for registering)

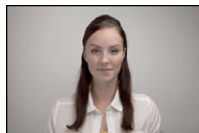

■ When recognition during recording is not successful

- Register the face of same person indoors and outdoors, or with different expressions or angles. (P125)
- Additionally register at the location of recording.
- When a registered person is not recognized, correct by re-registering.
- Face Recognition may not be possible or may not recognize faces correctly even for registered faces, depending on the facial expression and environment.

1 Select [Face Recog.] in the [Rec] menu and then press ►. (P49)

2 Press ▲/▼ to select [MEMORY] and then [MENU/SET].

3 Press ▲/▼/◀/▶ to select the Face Recognition frame that is not registered, and then [MENU/SET].

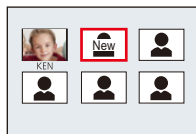

4 Take the picture with the face within the frame.

- A confirmation screen is displayed. It is executed when [Yes] is selected.
- The faces of subjects other than people (pets, etc.) cannot be registered.
- When [DISP.] is pressed, an explanation appears for taking face images.

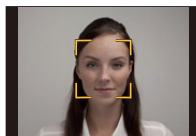

5 Select the item to edit with ▲/▼, and then press ►.

- You can register up to 3 face images.

Item	Description of settings
[Name]	<p>Allows registering names.</p> <p>1 Press ▼ to select [SET] and then [MENU/SET].</p> <p>2 Enter the name.</p> <ul style="list-style-type: none"> For details on how to enter characters, refer to “Entering Text” section on P126.
[Age]	<p>Allows registering birthdays.</p> <p>1 Press ▼ to select [SET] and then [MENU/SET].</p> <p>2 Press ◀/▶ to select the items (Year/Month/Day), ▲/▼ to set and then [MENU/SET].</p>
[Focus Icon]	<p>Changes the displayed focus icon when the subject is focused.</p> <p>Press ▲/▼ to select the focus icon, and then [MENU/SET].</p>
[Add Images]	<p>For adding additional face images.</p> <p>(Add Images)</p> <p>1 Select the unregistered face recognition frame, and then press [MENU/SET].</p> <p>2 Perform steps 4 in “Face Settings”.</p>
	<p>For deleting one of the face images.</p> <p>(Delete)</p> <p>Press ◀/▶ to select the face image to delete, and then [MENU/SET].</p> <ul style="list-style-type: none"> If there is only one image registered, it cannot be deleted.

- Exit the menu after it is set.

Changing or deleting the information for a registered person

You can modify the pictures or information of an already registered person. You can also delete the information of the registered person.

- 1 Select [Face Recog.] in the [Rec] menu, and then press ►. (P49)
- 2 Press ▼ to select [MEMORY] and [MENU/SET].
- 3 Press ▲/▼/◀/▶ to select the face image to edit or delete and then [MENU/SET].
- 4 Press ▲/▼ to select the item and then [MENU/SET].

Item	Description of settings
[Info Edit]	For changing the information of an already registered person. Perform step 5 in “Face Settings”.
[Priority]	For assigning focus and exposure preferentially to higher-priority faces. Press ▲/▼/◀/▶ to select the priority and then [MENU/SET].
[Delete]	For deleting information of a registered person.

- Exit the menu after it is set.

Entering Text

It is possible to enter babies' and pets' names and the names of travel destinations when recording. (Only alphabetical characters and symbols can be entered.)

1 Display the entry screen.

- You can display the entry screen via the following operations.
 - [Name] of [Baby1]/[Baby2] or [Pet] in Scene Mode
 - [Name] in [Face Recog.]
 - [Location] in [Travel Date]
 - [Title Edit]

2 Press ▲/▼/◀/▶ to select text and then [MENU/SET] to register.

- Move the cursor to [$\overset{A}{\underset{a}{\square}}$] and then press [MENU/SET] to switch text between [A] (capitals), [a] (lower case), [1] (numbers) and [&] (special characters).
- To enter the same character in a row, move the cursor by rotating the zoom lever to the [Q] (T) side or rotating the setting wheel to the right.
- The following operations can be performed by moving the cursor to the item and pressing [MENU/SET]:
 - []: Enter a blank
 - [Delete]: Delete a character
 - [◀]: Move the entry position cursor to the left
 - [▶]: Move the entry position cursor to the right
- A maximum of 30 characters can be entered. (Maximum of 9 characters when setting names in [Face Recog.]
- * A maximum of 15 characters can be entered for [\], [[], []], [•] and [—] (Maximum of 6 characters when setting names in [Face Recog.]).

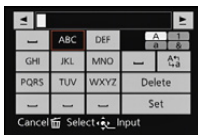

3 Press ▲/▼/◀/▶ to move the cursor to [Set] and then [MENU/SET] to end text input.

Notes

- Text can be scrolled if all of the entered text does not fit on the screen.
- Text is displayed in order of title, location, [Name] ([Baby1]/[Baby2], [Pet]), [Name] ([Face Recog.]).







Using the [Rec] menu

For details on [Rec] menu settings, refer to P49.

[Photo Style]

Applicable modes:         SCN COL

6 effects can be selected for the image you wish to record. It is possible to adjust the items such as color or picture quality of the effect to your desire.

Settings	Description of settings
 [Standard]	This is the standard setting.
 [Vivid]	Brilliant effect with high saturation and contrast.
 [Natural]	Soft effect with low contrast.
 [Monochrome]	Monochrome effect, i.e. colorless.
 [Scenery]	An effect appropriate for scenes with vivid blue skies and greens.
 [Portrait]	An effect appropriate for portrait picture with a healthy and beautiful skin tone.
 [Custom]	Use the setting registered in advance.

■ Adjusting the picture quality

- 1 Press ◀/▶ to select the type of Photo Style.
- 2 Press ▲/▼ to select the items, and then ◀/▶ to adjust.

Item		Effect
☾ [Contrast]	[+]	Increases the difference between the bright and dark parts in the picture.
	[-]	Decreases the difference between the bright and dark parts in the picture.
Ⓢ [Sharpness]	[+]	The picture is sharply defined.
	[-]	The picture is softly focused.
⊕ [Saturation]	[+]	The colors in the picture become vivid.
	[-]	The colors in the picture become desaturated.
NR [Noise Reduction]	[+]	The noise reduction effect is enhanced. Picture resolution may deteriorate slightly.
	[-]	The noise reduction effect is reduced. You can obtain pictures with higher resolution.

- Registered settings are memorized even if the camera is turned off.
- If you adjust the picture quality, [+] is displayed next to the Photo Style icon on the screen.
- The color can be changed by [Saturation] when [Monochrome] is selected.

3 Press ▼ to select [Custom setting] and then [MENU/SET].

- A confirmation screen is displayed. It is executed when [Yes] is selected.
- Setting can be registered in [Custom].

[Aspect Ratio]

Applicable modes: [A] [P] [A] [S] [M] [C1] [C2] [SCN] [COL]

This allows you to select the aspect ratio of the pictures to suit the subject, printing or the playback method.

Settings	Description of settings
[4:3]	[Aspect Ratio] of a 4:3 TV
[3:2]	[Aspect Ratio] of a 35mm film camera
[16:9]	[Aspect Ratio] of a high-definition TV, etc.
[1:1]	Square aspect ratio

Note

- The ends of the recorded pictures may be cut at printing so check before printing. (P200)

Resolution [Picture Size]

Applicable modes: **A** **P** **A** **S** **M** COM **C1** **C2** **SCN** **COL**

This mode allows setting the number of pixels, i.e. the resolution. The higher the resolution, the finer the detail of the pictures will appear even when they are printed onto large sheets.

[Aspect Ratio]: [4:3]	
[12M]	4000×3000
[8M [Z]]*	3264×2448
[5M [Z]]	2560×1920
[3M [Z]]*	2048×1536
[2M [Z]]*	1600×1200
[0.3M [Z]]	640×480

[Aspect Ratio]: [3:2]	
[10.5M]	4000×2672
[7M [Z]]*	3264×2176
[4.5M [Z]]*	2560×1712
[2.5M [Z]]*	2048×1360
[0.3M [Z]]*	640×424

[Aspect Ratio]: [16:9]	
[9M]	4000×2248
[6M [Z]]*	3264×1840
[3.5M [Z]]*	2560×1440
[2M [Z]]*	1920×1080
[0.2M [Z]]*	640×360

[Aspect Ratio]: [1:1]	
[9M]	2992×2992
[6M [Z]]*	2448×2448
[3.5M [Z]]*	1920×1920
[2.5M [Z]]*	1536×1536
[0.2M [Z]]*	480×480

* This item cannot be set in the Snapshot Mode.

Notes

- If you change the aspect ratio, set the resolution again.
- In specific modes, Extended Optical Zoom cannot be used, and the resolution for [**[Z]**] is not displayed. For details regarding modes in which Extended Optical Zoom cannot be used, refer to P71.
- Pictures may appear in mosaic depending on the subject and the recording conditions.
- You cannot set [Picture Size] when [Quality] is set to [RAW].

[Quality]

Applicable modes:

This mode allows setting the compression rate at which the pictures are to be stored.

Settings		Description of settings
	JPEG	A JPEG image in which image quality was given priority.
		A standard image quality JPEG image. This is useful for increasing the number of shots without changing the resolution.
/ 	RAW+JPEG	A RAW image and a JPEG image (or) are recorded simultaneously.*1
	RAW	Only RAW images are recorded.*2

*1 If you delete a RAW file from the camera, the corresponding JPEG image will also be deleted.

*2 This format is fixed to the maximum resolution for each image aspect ratio.

Notes

- [Quality] is fixed to in the following case.
 - [High Sens.] (Scene Mode)
- The following icons are displayed during 3D recording.
 - ([3D+Fine]): Both MPO images and fine JPEG images are recorded simultaneously.
 - ([3D+Standard]): Both MPO images and standard JPEG images are recorded simultaneously.
- You can enjoy more advanced picture editing if you use RAW files. You can save RAW files in a file format (JPEG, TIFF etc.) that can be displayed on your computer etc., develop them and edit them using the available software (P173).
- [RAW] images are recorded with a smaller data volume than or .

[ISO Limit Set]

Applicable modes:        SCN COL

This mode allows setting a highest ISO value limit for the automatic ISO setting modes.

Settings: [AUTO]/[200]/[400]/[800]/[1600]/[3200]

Notes

- This mode is available when [Sensitivity] is set to [AUTO] or [ISO].
- Setting items below will be selectable in Creative Video Mode.
Settings: [AUTO]/[200]/[400]/[800]/[1600]/[3200]/[6400]

[ISO Increments]

Applicable modes:        SCN COL

This mode allows selecting the ISO setting increments, i.e. in $\frac{1}{3}$ EV or 1EV steps.

Settings	ISO settings
[1/3 EV]	[100]/[125]/[160]/[200]/[250]/[320]/[400]/[500]/[640]/[800]/[1000]/[1250]/[1600]/[2000]/[2500]/[3200]/[H4000]*/[H5000]*/[H6400]*
[1 EV]	[100]/[200]/[400]/[800]/[1600]/[3200]/[H6400]*

* Only available when [Extended ISO] is set.

Note

- When the setting is changed from [1/3 EV] to [1 EV], the sensitivity will be set to value closest to the one set with [1/3 EV]. (The set value will not be restored when the setting is changed back to [1/3 EV]. It will stay as the setting selected for [1 EV].)

[Extended ISO]

Applicable modes:        SCN COL

This mode allows setting the ISO sensitivity up to [6400].

Settings: [ON]/[OFF]

[Face Recog.]

- Refer to [P122](#) for details.

[AF Mode]

- Refer to [P88](#) for details.

[AF Style]

Applicable modes:          

Select how the focus is adjusted when taking a still picture.

Settings	The movement of the subject and the scene (recommended)	Description of settings
AFS	Subject is still (Scenery, anniversary photograph, etc.)	“AFS” is an abbreviation of “Auto Focus Single”. Focus is set automatically and locked when the shutter release button is pressed halfway. Pictures can only be taken if focusing is successful.
AFF	Movement cannot be predicted (Children, pets, etc.)	“AFF” is an abbreviation of “Auto Focus Flexible”. In this mode, focusing is performed automatically and locked when the shutter release button is pressed halfway. If the subject moves during that time, the focus setting will automatically follow it.
AFC	Subject is moving (Sport, trains, etc.)	“AFC” is an abbreviation of “Auto Focus Continuous”. In this mode, while the shutter release button is pressed halfway, focusing is constantly performed, and, in the case of a moving subject, it is based on the predicted subject position at the time of recording. The setting is not locked

• When recording using [AFF], [AFC]

- Press the shutter release button halfway again when it is difficult to focus on the subject.
- While the shutter release button is pressed halfway, shaking may be seen on the screen.
- The battery will be consumed faster than usual.

[Quick AF]

Applicable modes: **P A S M** **C1 C2 SCN COL**

As long as the camera is held steady, it will automatically and continuously adjust the focus setting. Focusing will then be quicker when the shutter is pressed. This is useful when you do not want to miss a picture-taking opportunity.

Settings: [ON]/[OFF]

Notes

- The battery will be consumed faster than usual.
- Press the shutter release button halfway again when it is difficult to focus on the subject.
- This mode is not available together with AF tracking.
- You cannot set [Quick AF] in the following cases.
 - [Panning]/[Night Portrait]/[Night Scenery]/[Handheld Night Shot] (Scene Mode)
 - [Soft Focus] (Creative Control Mode)
 - When using Manual Focus

[AF/AE Lock]

- Refer to [P96](#) for details.

[Metering Mode]

Applicable modes: **P A S M** **C1 C2 SCN COL**

You can select between three different brightness metering methods.

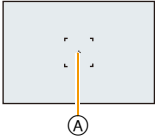
Settings	Description of settings
: Multiple	The brightness is detected in different sections of the frame. The exposure is then based on the probable main subject. Usually, we recommend using this method.
: Center-weighted	This method concentrates metering sensitivity on the subject in the center of the screen while also registering the rest of the frame.
: Spot	Only a small area in the center is registered . 

[i.Dynamic] (Intelligent dynamic range control)

Applicable modes:  **P** **A** **S** **M**  **C1** **C2** SCN COL

With this mode, contrast and exposure will be adjusted automatically when there is a big difference in brightness within the subject.

Settings: [HIGH]/[STANDARD]/[LOW]/[OFF]

Notes

- Even when [Sensitivity] is set to [100], [Sensitivity] may be set higher than [100] if the picture is taken with [i.Dynamic] set to valid.
- The compensation effect may not be achieved depending on the conditions.
- [LOW], [STANDARD], or [HIGH] represents the maximum range of the effect.

[Min. Shtr Speed]

Applicable modes:  **P** **A** **S** **M**  **C1** **C2** SCN COL

With this mode, you can pre-determine the shutter speed range the camera will use. Selecting a slower speed allows appropriate rendition of darker subjects without flash, selecting a faster speed can ensure blur-free pictures of moving subjects.

Settings: [AUTO], [1/250], [1/125], [1/60], [1/30], [1/15], [1/8], [1/4], [1/2], [1]

Minimum shutter speed setting	$\frac{1}{250}\text{s}$  1 s
Brightness	Darker Brighter
Camera shake	Less More

Notes

- This mode should usually be set to [AUTO] to take pictures. (When you select a minimum shutter speed other than [AUTO], [MIN] appears on the screen.)
- When [AUTO] is selected, shutter speeds up to 1 second may be set when there is not much camera shake to adjust with the [Stabilizer], or when [Stabilizer] is set to [OFF].
- Setting [Min. Shtr Speed] to slower speeds might increase blurring due to camera shake, so it may be advisable to use a tripod and the self-timer.
- Setting [Min. Shtr Speed] to faster speeds might prevent the correct rendition of darker subjects. If a correct exposure cannot be achieved, [MIN] will flash in red when the shutter release button is pressed halfway.

[i.Resolution]

Applicable modes:

With this mode, pictures with sharp profile and resolution can be taken by utilising the Intelligent Resolution Technology.

Settings	Description of settings
[i.ZOOM]	[i.Resolution] is activated, and zoom magnification increased to 2 times while limiting deterioration of the picture.
[ON]	[i.Resolution] is activated.
[OFF]	—

Note

- Refer to [P68](#) for information about the Intelligent Zoom.

[Digital Zoom]

Applicable modes:

With this mode, you can enlarge subjects even more than with the Optical Zoom, the Extended Optical Zoom or the Intelligent Zoom.

Settings: [ON]/[OFF]

Note

- Refer to [P68](#) for details.

[Stabilizer]

Applicable modes:          

Using this mode, camera shake during picture taking is detected, and the camera automatically compensates for it, enabling less blurred, or even blur-free images to be taken.

When recording motion pictures, "Active Mode" (stabilizer for motion pictures) will automatically function. This decreases image blurring when recording motion pictures while walking, etc.

Settings: [ON]/[OFF]

 **Notes**

- In "Active Mode", a stronger effect of the correction can be achieved at the wide focal length end.
- In the following case, "Active Mode" will not function even when recording motion pictures.
 - When [Rec Mode] is set to [VGA] in [MP4]

The stabilizer function may not be effective in the following cases. Make sure to hold the camera steady while pressing the shutter release button.

 - When there is a lot of camera shake.
 - When the zoom magnification is high.
 - In the digital zoom range.
 - When taking pictures while following a moving subject.
 - When the shutter speed becomes slower due to darker subjects.
- When [ON] in the Scene Mode [Panning] is selected, the Optical Image Stabilizer is only available when using in the vertical orientation.
- The setting is fixed to [ON] in the following case.
 - [Handheld Night Shot] (Scene Mode)
- The setting is fixed to [OFF] in the following cases.
 - [Panorama Shot]/[3D Photo Mode] (Scene Mode)
 - [High Speed Video] (Creative Video Mode)

[AF Assist Lamp]

Applicable modes: **P A S M** **C1 C2 SCN COL**

The AF Assist Lamp will illuminate the subject when the shutter release button is pressed half-way making it easier for the camera to focus when recording in low light conditions. (A larger AF frame is displayed depending on the recording conditions.)

Settings: [ON]/[OFF]

Notes

- The effective range of the AF Assist Lamp is approx. 1.5m / 5'.
- When you do not want to use the AF Assist Lamp (e.g. when taking pictures of animals in dark places), set the [AF Assist Lamp] to [OFF]. In this case, it will become more difficult to focus on the subject.
- Depending on its focal length setting, the lens may partly obstruct the light of the AF Assist Lamp, however, this does not cause a problem with the performance of the camera.
- [AF Assist Lamp] is fixed to [OFF] in the following cases.
 - [Scenery]/[Panning]/[Night Scenery]/[Handheld Night Shot]/[Sunset]/[Glass Through] (Scene Mode)

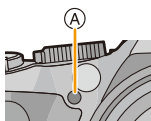



[Flash]

- Refer to [P72](#) for details.

[Flash Synchro]

Applicable modes: **P A S M** **C1 C2** **COL**

2nd curtain synchro activates the flash just before the shutter closes. This function can help to produce more natural looking flash pictures of moving subjects which have their own light sources especially with slower shutter speeds.

Settings	Description of settings
[1ST]	1st curtain synchro The normal method when taking pictures. 
[2ND]	2nd curtain synchro The light source appears behind the subject which makes the picture appear more natural. 

Notes

- Set it to [1ST] for normal use.
- [2nd] is displayed in the flash icon on the screen if you set [Flash Synchro] to [2ND].
- When a fast shutter speed is set, the effect of [2ND] may not be apparent.

[Flash Adjust.]

Applicable modes:      CMO    COL



This mode allows adjusting the flash output if the recorded pictures are too bright or too dark.

Notes

- You can adjust from [-2 EV] to [+2 EV] in steps of [1/3 EV].
- Select [0 EV] to return to the standard flash output.
- [+] or [-] is displayed on the flash icon in the screen when the flash level is adjusted.

[Red-Eye Removal]

Applicable modes:      CMO    COL

When the Red-Eye Reduction (, ) is selected, Red-Eye Removal is performed whenever the flash is used. The camera automatically detects red-eye and corrects the picture.

Settings: [ON]/[OFF]

Notes

- This mode is only available when [AF Mode] is set to  and Face Detection is active.
- Under certain circumstances, the red-eye effect cannot be corrected.
- The setting is fixed to [ON] with Snapshot Mode.
- [Red-Eye Removal] cannot be used in the following cases.
 - [3D Photo Mode] (Scene Mode)

[Auto Bracket]

Applicable modes:  **P A S M C1 C2 SCN COL**

In this mode, 3 pictures are automatically recorded with the selected exposure steps each time the shutter release button is pressed.

With Auto Bracketing $\pm 1\text{EV}$

1st picture



$\pm 0\text{EV}$

2nd picture



-1EV

3rd picture





+1EV

Press   to select the exposure interval and then [MENU/SET].

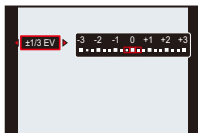
- When you do not want to use Auto Bracketing, select [OFF] (0).



Notes

- When Auto Bracketing is set,  is displayed on the screen.
- When taking pictures using Auto Bracketing after setting an exposure compensation value, the pictures taken are based on this value.
- The exposure may not be compensated with Auto Bracketing depending on the brightness of the subject.
- In Shutter-Priority and manual exposure modes, if the shutter speed is set to more than 1 second, Auto Bracketing is canceled.
-  is set for the flash when Auto Bracketing is set.
- You cannot use the Auto Bracketing in following conditions.
 - [Miniature Effect]/[Soft Focus]/[Star Filter] (Creative Control Mode)
 - [Panorama Shot]/[Handheld Night Shot]/[HDR]/[3D Photo Mode] (Scene Mode)
 - When recording motion pictures

[Date Stamp]

Applicable modes:         

This mode allows taking a picture with date and time of recording.

Settings	Description of settings
[W/O TIME]	Stamps the year, month, and day.
[WITH TIME]	Stamps the year, month, day, hour, and minutes.
[OFF]	—

Notes

- Date information for pictures recorded with [Date Stamp] set cannot be deleted.
- When printing pictures with [Date Stamp] at a shop or with a printer, the date will be printed on top of the other if you choose to print with the date.
- If the time has not been set, you cannot stamp with the date information.
- The camera cannot stamp the date in the following cases.
 - The clock is not set
 - The [Quality] option is set to [RAW]
- The setting is fixed to [OFF] in the following cases.
 - When recording motion pictures
 - When using Auto Bracketing
 - [Panorama Shot]/[3D Photo Mode] (Scene Mode)
 - When using [Burst].
- [Text Stamp], [Resize], [Cropping] and [Leveling] cannot be set for pictures recorded with [Date Stamp] set.
- Even if you take a picture with [Date Stamp] set to [OFF], it is possible to stamp dates onto the recorded pictures using [Text Stamp] (P155) or setup the Date print (P163, 180).

[Clock Set]

- Refer to P24 for details.

Using the [Motion Picture] menu

For details on [Motion Picture] menu settings, refer to P49.

In Creative Video Mode, the settable [Rec] menu will be displayed in the [Motion Picture] menu.

- The [Motion Picture] menu is not displayed in the following cases.
 - [Panorama Shot]/[3D Photo Mode] (Scene Mode)
 - [Soft Focus]/[Star Filter] (Creative Control Mode)

[Rec Mode]

Applicable modes: **A** **P** **A** **S** **M** **MM** **C1** **C2** **SCN** **COL**

This mode allows setting the data format of motion pictures.

Settings	Description of settings
[AVCHD]	Select this format to record HD (high definition) motion pictures for playback on your HDTV using an HDMI connection.
[MP4]	Select this format to record standard definition motion pictures for playback on your computer.

[Rec Quality]

Applicable modes: **A** **P** **A** **S** **M** **M** **C1** **C2** **SCN** **COL**

This mode allows setting up the picture quality of motion pictures.

When [AVCHD] is selected

Settings	Resolution/Bit rate	fps	Aspect ratio
[PSH]	1920×1080 pixels/Approx. 28 Mbps	50p ^{*1} (60p ^{*2})	16:9
[FSH]	1920×1080 pixels/Approx. 17 Mbps	50i ^{*1} (60i ^{*2})	
[SH]	1280×720 pixels/Approx. 17 Mbps	50p ^{*1} (60p ^{*2})	

When [MP4] is selected

Settings	Resolution/Bit rate	fps	Aspect ratio
[FHD]	1920×1080 pixels/Approx. 20 Mbps	25 ^{*1} (30 ^{*2})	16:9
[HD]	1280×720 pixels/Approx. 10 Mbps		4:3
[VGA]	640×480 pixels/Approx. 4 Mbps		



Notes

• What is bit rate

This is the volume of data for a definite period of time, and the quality becomes higher when the number gets bigger. The camera uses the "VBR" recording method. "VBR" is an abbreviation of "Variable Bit Rate", which means that the bit rate (volume of data for definite period of time) is changed automatically depending on the subject being recorded. Therefore, the recording time is shortened when a subject with fast movement is recorded.

*1 With camera model 18 190

*2 With camera models 18 191 / 18 192

[High Speed Video]

Applicable modes:

This mode allows setting the picture quality for [High Speed Video] recording in the Creative Video Mode.

- This menu is displayed only when [High Speed Video] is set.

Settings	Description of settings
[200fps VGA]*1 ([240fps VGA])*2	Recording 200*1(240*2) frames/second in [VGA] of [MP4]
[100fps HD]*1 ([120fps HD])*2	Recording 100*1(120*2) frames/second in [HD] of [MP4]

*1 With camera model 18 190

*2 With camera models 18 191 / 18 192

[Continuous AF]

Applicable modes:

With this mode, the focus setting is continuously adjusted according to the targeted subject.

Settings: [ON]/[OFF]

Note

- Set this function to [OFF] if you wish to fix the focus on the position where you started the motion picture recording.

[Wind Cut]

Applicable modes:          

This mode prevents the recording of wind-noise automatically.

Settings: [AUTO]/[OFF]

Notes

- The sound quality may be different than usual when [Wind Cut] is set.
- It is fixed to [OFF] in the following cases.
 - [Miniature Effect] (Creative Control Mode)
 - When the [Zoom Mic] is set to [ON]
 - [High Speed Video] (Creative Video Mode)

[Zoom Mic]

Applicable modes:          

Coupled to the zoom operation, this mode delivers clear recordings of far sounds with tele, and surrounding sounds with wide.

Settings: [ON]/[OFF]

Notes

- When set to [ON] and performing zoom, the operation sound may be recorded enhanced in accordance with the surrounding sounds. Also, audio recording level will be lower compared to when [OFF].
- The stereo effect of the audio recording is reduced when the picture is enlarged.
- It is fixed to [OFF] in the following cases.
 - [Miniature Effect] (Creative Control Mode)
 - [High Speed Video] (Creative Video Mode)

Having Fun with Recorded Pictures

[Auto Retouch]

This mode allows balancing brightness and color of the pictures taken.

- With [Auto Retouch], a new edited picture is created. Check that there is free space on the internal memory or the card.

[Auto Retouch] cannot be used if the card's Write-Protect switch is set to [LOCK].



- * These pictures are examples to show the effect.

- 1** Press **◀/▶** to select a picture, and then **▲**.
- 2** Press **▲/▼** to select [Auto Retouch], and then [MENU/SET].
- 3** Press **▲/▼** to select [ON], and then [MENU/SET].

- A confirmation screen is displayed. It is executed when [Yes] is selected.

Notes

- Depending on the picture, noise may be emphasized by [Auto Retouch].
- Effects may be difficult to see depending on the picture.
- It may not be possible to perform [Auto Retouch] on pictures which have already been retouched.
- It may not be possible to perform [Auto Retouch] on pictures recorded with other equipment.
- [Auto Retouch] is not possible in the following cases:
 - Motion pictures
 - 3D pictures
 - Pictures taken in [Panorama Shot] in Scene Mode

[Creative Retouch]

This mode allows adding your desired effects to the pictures that you have taken.

- With [Creative Retouch], a new edited picture is created. Check that there is free space on the internal memory or the card.

[Creative Retouch] cannot be used if the card's Write-Protect switch is set to [LOCK].

1 Press ◀/▶ to select a picture, and then ▲.

2 Press ▲/▼ to select [Creative Retouch], and then [MENU/SET].

3 Press ▲/▼ to select an item, and then [MENU/SET].

- You can select the item from the following options that are also available in the Creative Control mode. Read P112 for details on the respective effects.

[Expressive]/[Retro]/[High Key]/[Low Key]/[Sepia]/[Dynamic Monochrome]/[Impressive Art]/
[High Dynamic]/[Cross Process]/[Toy Effect]/[Miniature Effect]/[Soft Focus]/[Star Filter]/[One
Point Color]

- A confirmation screen is displayed. It is executed when [Yes] is selected.
- If you press [MENU/SET] while the following items are selected, you can add the image effect that matches your preference.

- [Cross Process]: You can select the image effect from Greenish, Bluish, Yellowish or Reddish.
- [Toy Effect]: You can select the image effect from Orange emphasized, Standard, Blue emphasized.
- [One Point Color]: Set the color you want to leave.

Notes

- Effects may be difficult to see depending on the picture.
- The image effect may appear weak compared to the effect given by the Creative Control Mode.
- It may not be possible to perform [Creative Retouch] on pictures recorded with other equipment.
- [Creative Retouch] is not possible in the following cases:
 - Motion pictures
 - 3D pictures
 - Pictures taken in [Panorama Shot] in Scene Mode

Playing Back Picture Series

About the picture series group

Pictures taken with the frame rate set to [] or [] are recorded as a single picture series group.

The picture series icon [] will be displayed for the picture series group.

- Deleting and editing within a group is possible. (For example, if you delete a picture series group with [], all the pictures in that group are deleted.)

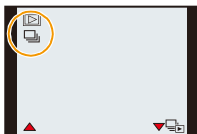

Notes

- Picture series recorded after their number has exceeded 50000 will not be grouped.
- Picture series recorded on other cameras may not be recognized as a picture series group.
- Picture series will not be grouped if recorded without setting the clock.
- If you delete all pictures except one, that picture will be saved as a single picture instead of as a picture series group.

Continuously playing back picture series

Press ◀/▶ to select a picture with a picture series icon [], and then ▲.

Operations when continuously playing back the picture series group

The cursor displayed during playback is the same as ▲/▼/◀/▶.

▲	Play/Pause	
▼	Stop	
◀	Fast rewind, Previous picture*	
▶	Fast forward, Next picture*	

* These operations can be performed only in the Pause Mode.

Playing back single pictures from a series

1 Select a picture with a picture series icon [], and then press ▼.

2 Press ◀/▶ to select the picture.

- Press ▼ again to return to the normal playback screen.
- The same playback controls used for normal pictures can be used for pictures within the picture series group. (Such as Multi Playback, Playback Zoom and deleting images)

Editing Picture Series

• The following editing menu can be used.

- [Title Edit]/[Text Stamp]/[Resize]/[Cropping]*/[Leveling]*/[Favorite]/[Print Set]/[Protect]/[Copy]
- * Cannot be used for the entire picture series group.

Editing in picture series groups units (All pictures in the picture series group)

- 1 Press [MENU/SET] during playback to display the [Playback] menu. (P49)
- 2 Press ▲/▼ to select item, and ▶.
- 3 Select [Single] or [Multi] and then press [MENU/SET].
- 4 Select an image with the picture series icon [🖼️], and perform editing.

Editing single pictures within a picture series group

- 1 Select a picture with the picture series icon [🖼️], and then press ▼.
- 2 Press [MENU/SET] to display the [Playback] menu.
- 3 Press ▲/▼ to select item, and then ▶.
- 4 Select [Single] or [Multi] and then press [MENU/SET].
- 5 Select the picture, and perform editing.

■ About the display of [Favorite], [Print Set] and [Protect] icons during playback of picture series groups

By setting [Favorite] (P161), [Print Set] (P162), or [Protect] (P164) setting to a picture in the picture series group, the number of settings (number of settings and total number when [Print Set] is set) is displayed on the icon for the first picture of each group.

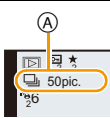
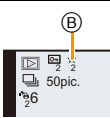
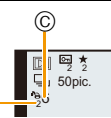
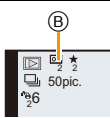
Initial screen for picture series groups (first picture of the series)	[Favorite]	[Print Set]	[Protect]
			
<p>(A) Total number of all pictures stored within the picture series group.</p> <p>(B) Number of pictures in a given picture series group subject to a setting.</p> <p>(C) Total number of prints set over all picture series groups.</p> <ul style="list-style-type: none"> • For example, if 3 pictures are to be printed from each of 2 pictures within the group, a "6" will appear here. 			

📌 Notes

- For details on the various ways of editing, refer to "Using the [Playback] menu". (P154)
- Pictures for which you have performed [Text Stamp], [Resize], [Cropping] or [Leveling] will be saved separately from picture series groups.

Various playback methods

This mode allows you to play back the recorded pictures in various methods.

- 1 Press **[MENU/SET]** during playback.
- 2 Press **▶**.
- 3 Press **▲/▼** to select the item and then **[MENU/SET]**.

- The following can be selected.

[2D/3D Settings]*
[Normal Play] (P42)
[Slide Show] (P149)

[Filtering Play] (P152)
[Calendar] (P153)

- * The playback method for 3D pictures can be switched. This item is only displayed during HDMI output. Refer to P171 for details about the playback method.

[Slide Show]

This mode allows you to play back the pictures you have taken in synchronisation with music, and you can do this in sequence while leaving a fixed interval between each of the pictures. You can also put together a slide show composed of only still pictures, only motion pictures, only 3D pictures etc.

We recommend this feature when you view your pictures by connecting the camera to a TV.

- 1 Select the group to play back by pressing **▲/▼**, and then press **[MENU/SET]**.

- Refer to P171 for the method to play back [3D Play] pictures in 3D.
- During [Category Selection], press **▲/▼/◀/▶** to select a category, and then **[MENU/SET]**. Refer to P152 for category details.

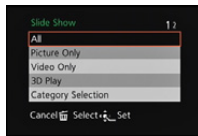



- 2 Press **▲** to select **[Start]** and then **[MENU/SET]**.

- 3 Press **▼** to finish the slide show.

- Normal playback resumes after the slide show finishes.

■ Operations performed during slide show

The cursor displayed during playback is the same as ▲/▼/◀/▶.

▲	Play/Pause	
▼	Stop	
◀	Back to previous picture*	
▶	Ahead to next picture*	
[W]	Reduce volume level	
[T]	Increase volume level	

* Operable only in the following cases.

- in the Pause Mode
- during motion picture playback
- during picture series group playback
- during panorama picture playback

■ Changing the slide show settings

You can change the settings for slide show playback by selecting [Effect] or [Setup] on the slide show menu screen.

[Effect]

This allows you to select the screen effects when switching from one picture to the next.

[NATURAL], [SLOW], [SWING], [URBAN], [OFF], [AUTO]

- When [URBAN] has been selected, the picture may appear in black and white as a screen effect.
- [AUTO] can be used only when [Category Selection] has been selected. The pictures are played back with the recommended effects in each category.
- [Effect] is fixed to [OFF] during the [Video Only] slide show, or during a slide show of  in [Category Selection].
- Even if [Effect] is set, it does not work during a slide show of a picture series group.
- Some [Effect] will not operate when playing back pictures displayed vertically.
- Screen effects do not operate during a [3D Play] slide show.

[Setup]

[Duration] or [Repeat] can be set.

Settings	Description of settings
[Duration]	[1 SEC.]/[2 SEC.]/[3 SEC.]/[5 SEC.]
[Repeat]	[ON]/[OFF]
[Sound]	<p>[AUTO]: Music is played when the still pictures are played back, and audio is played when the motion pictures are played back.</p> <p>[Music]: Music is played back.</p> <p>[Audio]: Audio (only for motion pictures) is played back.</p> <p>[OFF]: There will be no sound.</p>

- [Duration] can be set only when [OFF] has been selected as the [Effect] setting.
- The [Duration] setting is not applicable to the following images during a slide show.
 - Motion pictures
 - Picture series group
 - Panorama pictures

[Filtering Play]

This mode allows you to determine which kinds of recordings are to be played back, i.e. only still pictures, only motion pictures, or only 3D pictures etc., and played back.

Settings	Description of settings
[Picture Only]	Only still pictures are played back.
[Video Only]	Only motion pictures are played back.
[3D Play]	Only 3D pictures are played back. • Refer to P171 for the method to play back [3D Play] pictures in 3D.
[Category Selection]	<p>This mode allows you to search images by Scene Mode or other categories (such as [Portrait], [Scenery] or [Night Scenery]) and sort the pictures into each of the categories. You can then play back the pictures in each category.</p> <p>Press ▲/▼/◀/▶ to select the category and then [MENU/SET] to set.</p> <p>• Only the category for which pictures have been found can be selected.</p>
[Favorite]	You can play back the pictures you have set as [Favorite] (P161).

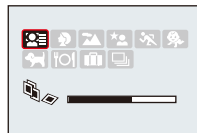

■ About the categories to be sorted

It will be sorted as following when [Category Selection] is set.

	Recording information e.g. Scene Modes
	[Face Recog.]*
	[Portrait], [i-Portrait], [Soft Skin], [Night Portrait], [i-Night Portrait], [Baby1]/[Baby2], [i-Baby]
	[Scenery], [i-Scenery], [Panorama Shot], [Sunset], [i-Sunset], [Glass Through]
	[Night Portrait], [i-Night Portrait], [Night Scenery], [i-Night Scenery], [Handheld Night Shot], [iHandheld Nite Shot]
	[Sports], [Panning]
	[Baby1]/[Baby2], [i-Baby]
	[Pet]
	[Food]
	[Travel Date]
	Pictures taken with the frame rate set to [60p] or [30p]

* Press ▲/▼/◀/▶ to select the person to play back and then [MENU/SET].

The whole group with pictures taken with the frame rate settings [60p] and [30p] will be treated as face recognition pictures.

[Calendar]

This mode allows you to display pictures by recording date.

1 Press ▲/▼/◀/▶ to select the date to be played back.

- If there were no pictures recorded during a month, that month is not displayed.



2 Press [MENU/SET] to display the pictures that were recorded on the selected date.

- Press [🗑️/➡️] to return to the calendar screen.

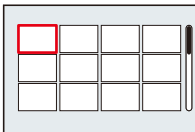

Notes

- The recording date of the picture selected in the playback screen becomes the date selected when the calendar screen is first displayed.
- If there are multiple pictures with the same recording date, the first picture recorded on that day is displayed.
- You can display the calendar between January 2000 and December 2099.
- If the date is not set in the camera, the recording date is set as the 1st January, 2012.
- If you take pictures after setting the travel destination in [World Time], the pictures are displayed by the dates at the travel destination in Calendar Playback.

Using the [Playback] menu

- You can use various functions in Playback Mode to resize pictures, set protection for them etc.
- With [Text Stamp], [Resize], [Cropping] or [Leveling], a new, edited picture is created. A new picture cannot be created if there is no free space on the internal memory or the card so we recommend checking that there is free space and then editing the picture.

[Title Edit]

This mode allows you to add text (comments) to pictures. After text has been registered, it can be stamped in prints using [Text Stamp] (P155).

- 1 Select [Title Edit] in the [Playback] menu. (P49)
- 2 Press ▲/▼ to select [Single] or [Multi] and then [MENU/SET].
- 3 Select the picture, and then press [MENU/SET] to set.

-  is displayed for pictures with titles already registered.

[Multi] setting

Press [DISP.] to set (repeat), and then [MENU/SET] to set.

- The setting is canceled when [DISP.] is pressed again.

- 4 Enter the text. (P126)

- Exit the menu after it is set.

Notes

- To delete the title, erase all the text in the text input screen.
- You can set up to 100 pictures at one time with [Multi].
- You cannot use [Title Edit] for the following pictures.
 - Motion pictures
 - 3D pictures
 - Pictures recorded with other equipment
 - Pictures taken with [RAW₁], [RAW₂] or [RAW]

[Single]

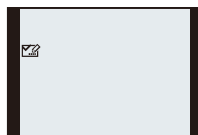

Press ◀/▶ to select the picture.

[Multi]

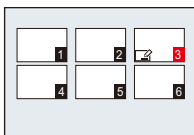

Press ▲/▼/◀/▶ to select the pictures.

[Text Stamp]

You can stamp the recording date/time, name, location, Travel Date or title onto the recorded pictures.

- 1 Select [Text Stamp] in the [Playback] menu. (P49)
- 2 Press ▲/▼ to select [Single] or [Multi] and then [MENU/SET].
- 3 Select the picture, and then press [MENU/SET] to set.

- [☑] is displayed on pictures already with date or text stamped.

[Multi] setting

Press [DISP.] to set (repeat), and then press [MENU/SET] to set.

- The setting is canceled when [DISP.] is pressed again.

[Single]



Press ◀/▶ to select the picture.

[Multi]

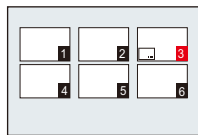

Press ▲/▼/◀/▶ to select the pictures.

- 4 Press ▲/▼ to select text stamp items, and then ▶.
- 5 Press ▲/▼ to select the settings, and then [MENU/SET].

Settings	Description of settings
[Shooting Date]	<p>[W/O TIME]: Stamps the year, month and day.</p> <p>[WITH TIME]: Stamps the year, month, day, hour and minutes.</p> <p>[OFF]</p>
[Name]	<p>[☺]: Stamps names registered in name settings for [Face Recog.].</p> <p>[☺/☺]: Stamps names registered in name settings for [Baby1]/[Baby2] or [Pet] in Scene Mode.</p> <p>[OFF]</p>
[Location]	<p>[ON]: Stamps the travel destination name set under [Location].</p> <p>[OFF]</p>
[Travel Date]	<p>[ON]: Stamps the Travel Date set under [Travel Date].</p> <p>[OFF]</p>
[Title]	<p>[ON]: Stamps the title input in the [Title Edit].</p> <p>[OFF]</p>

6 Press [MENU/SET].

- A confirmation screen is displayed. It is executed when [Yes] is selected.
Exit the menu after it is executed.

Notes

- When you print pictures stamped with text, the date will be printed over the stamped text if you specify printing of the date at the photo shop or on the printer.
- You can set up to 100 pictures at one time in [Multi].
- The picture quality may deteriorate when text stamping is carried out.
- Depending on the printer being used, some characters may be cut at printing. Check before printing.
- When text is stamped onto the images with less resolution than 0.3 M, it is difficult to read it.
- Text and dates cannot be stamped on the pictures in the following cases.
 - Motion pictures
 - Pictures taken in [Panorama Shot] in Scene Mode
 - 3D pictures
 - Pictures recorded without setting the clock and title
 - Pictures with date or text stamped
 - Pictures recorded with other equipment
 - Pictures taken with [RAW $\frac{1}{2}$], [RAW $\frac{1}{4}$] or [RAW]

[Video Divide]

Recorded motion pictures can be split. It is recommended, e.g. for when you want to separate a part you need from one part you do not need.

A motion picture cannot be restored once it has been split.

- 1 Select **[Video Divide]** in the **[Playback]** menu. (P49)
- 2 Press **◀/▶** to select the motion picture to divide, and then **[MENU/SET]**.

- 3 Press **▲** at the location to split.

- The motion picture is played back from the same location when **▲** is pressed again.
- You can finely adjust the location for the separation by pressing **◀/▶** while the motion picture is paused.

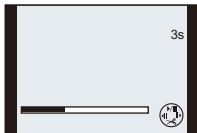

- 4 Press **▼**.

- A confirmation screen is displayed. It is executed when **[Yes]** is selected. Exit the menu after it is executed.
- Motion pictures may be lost if the card or battery is removed while processing the separation.

Notes

- It may not be possible to perform [Video Divide] for motion pictures recorded with other equipment.
- Motion pictures cannot be split at a location close to the start or end.
- With [MP4] motion pictures, the order of pictures will change if split.
It is recommended to search these motion pictures by using [Calendar] or [Video Only] in the [Filtering Play].
- Motion pictures with a short recording time cannot be split.

[Resize]

This mode allows easy posting to web pages, attachment to e-mail etc., the resolution (number of pixels) is reduced.

- 1 Select **[Resize]** in the **[Playback]** menu. (P49)
- 2 Press **▲/▼** to select **[Single]** or **[Multi]** and then **[MENU/SET]**.
- 3 Select the picture and the resolution.

[Single] setting

- 1 Press **◀/▶** to select the picture, and then **[MENU/SET]**.
- 2 Press **◀/▶** to select the resolution, and then **[MENU/SET]**.
 - A confirmation screen is displayed. It is executed when **[Yes]** is selected.
 - Exit the menu after it is executed.

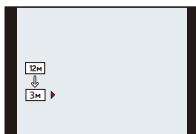

[Multi] setting

- 1 Press **▲/▼** to select the resolution, and then **[MENU/SET]**.
- 2 Press **▲/▼/◀/▶** to select the picture, then press **[DISP.]**.
 - Repeat this step for each picture, and press **[MENU/SET]** to set.
 - A confirmation screen is displayed. It is executed when **[Yes]** is selected.
 - Exit the menu after it is executed.

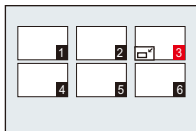

Notes

- You can set up to 100 pictures at one time in **[Multi]**.
- The picture quality of the resized picture will deteriorate.
- It may not be possible to resize pictures recorded with other equipment.
- The **[Resize]** feature is disabled during the following conditions:
 - Motion pictures
 - Pictures taken in **[Panorama Shot]** in **Scene Mode**
 - 3D pictures
 - Pictures with date or text stamped
 - Pictures taken with **[RAW₁]**, **[RAW₂]** or **[RAW]**

[Cropping]

This mode allows you to enlarge and then crop the important part of the recorded picture.

- 1** Select **[Cropping]** in the **[Playback]** menu. (P49)
- 2** Press **◀/▶** to select the picture, and then **[MENU/SET]**.
- 3** Use the zoom lever and press **▲/▼/◀/▶** to select the parts to be cropped.



Rotating the zoom lever towards T: Enlargement

Rotating the zoom lever towards W: Reduction

▲/▼/◀/▶: Moves the cropped section in that direction

- 4** Press **[MENU/SET]**.

- A confirmation screen is displayed. It is executed when [Yes] is selected.
Exit the menu after it is executed.

Notes

- The picture quality of the cropped picture will deteriorate.
- It may not be possible to crop pictures recorded with other equipment.
- Information regarding the Face Recognition in the original picture will not be copied to images having undergone [Cropping].
- The [Cropping] feature is disabled during the following conditions:
 - Motion pictures
 - Pictures taken in [Panorama Shot] in Scene Mode
 - 3D pictures
 - Pictures with date or text stamped
 - Pictures taken with [RAW $\frac{1}{2}$], [RAW $\frac{1}{4}$] or [RAW]

[Leveling]

This mode allows minute tilting of the image can be adjusted.

- 1** Select **[Leveling]** in the **[Playback]** menu. (P49)
- 2** Press **◀/▶** to select the picture, and then **[MENU/SET]**.
- 3** Press **◀/▶** to adjust the tilting, and **[MENU/SET]**.

▶: clockwise

◀: counter-clockwise

- Adjustments of up to 2° are possible.
 - A confirmation screen is displayed. It is executed when **[Yes]** is selected.
- Exit the menu after it is executed.

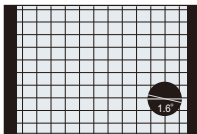

Notes

- The quality of the image may deteriorate when leveling is performed.
- It may not be possible to perform leveling on images recorded with other equipment.
- Information regarding the Face Recognition in the original picture will not be copied to images having undergone **[Leveling]**.
- The **[Leveling]** feature is disabled during the following conditions:
 - Motion pictures
 - Pictures taken in **[Panorama Shot]** in Scene Mode
 - 3D pictures
 - Pictures with date or text stamped
 - Pictures taken with **[RAW₁]**, **[RAW₂]** or **[RAW]**

[Favorite]

This mode allows you to do the following if a mark has been added to pictures and they have been set as favorites.

- Play back only the pictures set as favorites. ([Favorite] in [Filtering Play])
- Play back the pictures set as favorites only as a slide show.
- Delete all the pictures not set as favorites. ([All Delete Except Favorite])

1 Select [Favorite] in the [Playback] menu. (P49)**2 Press ▲/▼ to select [Single] or [Multi] and then [MENU/SET].****3 Select the picture, and then press [MENU/SET].**

- The settings are canceled when [MENU/SET] is pressed again.
- Exit the menu after it is set.

[Single]

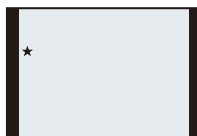

Press ◀/▶ to select the picture.

[Multi]

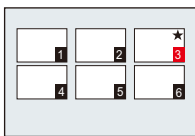

Press ▲/▼/◀/▶ to select the pictures.

■ Canceling all the [Favorite] settings**1 Select [Favorite] on the [Playback] menu.****2 Press ▲/▼ to select [Cancel] and then [MENU/SET].**

- A confirmation screen is displayed. It is executed when [Yes] is selected. Exit the menu after it is executed.

📌 Notes

- You can set up to 999 pictures as favorites.
- You may not be able to set pictures taken with other equipment as favorites.
- The [Favorite] feature is disabled during the following conditions:
 - Pictures taken with [RAW]

[Print Set]

DPOF "Digital Print Order Format" is a system that allows the user to select which pictures to print, how many copies of each picture to print and whether or not to print the recording date on the pictures when using a DPOF compatible photo printer or photo printing store. For details, ask at your photo printing store.

When you want to use a photo printing store to print pictures recorded in the internal memory, copy them to a card (P166) and then set the print setting.

- When you set [Print Set] for a picture series group, the print setting for the number of prints will be applied to every picture in the group.

- 1 Select [Print Set] in the [Playback] menu. (P49)
- 2 Press ▲/▼ to select [Single] or [Multi] and then [MENU/SET].
- 3 Select the picture, and then press [MENU/SET].

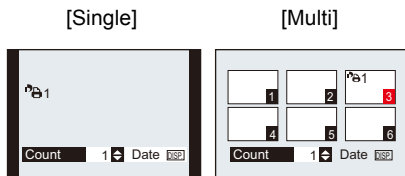

Press ◀/▶ to select the picture.

Press ▲/▼/◀/▶ to select the pictures.

- 4 Press ▲/▼ to set the number of prints, and then [MENU/SET] to set.

- When [Multi] has been selected, repeat steps 3 and 4 for each picture.
- [+999] is displayed on the screen, if the total number of prints you set for a picture series group is more than 1000 pictures.
- Exit the menu after it is set.

■ Canceling all the [Print Set] settings

- 1 Select [Print Set] in the [Playback] menu.
- 2 Press ▲/▼ to select [Cancel] and then [MENU/SET].
 - A confirmation screen is displayed. It is executed when [Yes] is selected.
Exit the menu after it is executed.

■ To print the date

After setting the number of prints, set/cancel printing with the recording date by pressing [DISP.].

- Depending on the photo printing store or the printer, the date may not be printed even if you set to print the date. For further information, ask at your photo printing store or refer to the instructions for the printer.
- The date cannot be printed on pictures with date or text stamped.

📘 Notes

- The number of prints can be set from 0 to 999.
- Depending on the printer, the date print settings of the printer may take precedence so check if this is the case.
- If the file is not based on the DCF standard, the DPOF print setting cannot be set.
- It may not be possible to use the print settings with other equipment. In this case, cancel all the settings, and reset the settings.
- The [Print Set] feature is disabled during the following conditions:
 - Motion pictures
 - Pictures taken with [RAW]

[Protect]

This mode allows you to set protection for pictures you do not want to be deleted by mistake.

- 1** Select **[Protect]** in the **[Playback]** menu. (P49)
- 2** Press **▲/▼** to select **[Single]** or **[Multi]** and then **[MENU/SET]**.
- 3** Select the picture, and then press **[MENU/SET]** to set.

- The settings are canceled when **[MENU/SET]** is pressed again.
- Exit the menu after it is set.

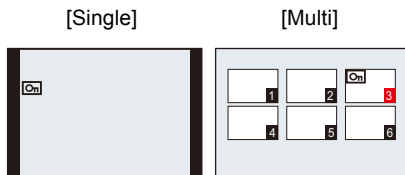

Press **◀/▶** to select the picture. Press **▲/▼/◀/▶** to select the pictures.

■ Canceling all the **[Protect]** settings

- 1** Select **[Protect]** in the **[Playback]** menu.
- 2** Press **▲/▼** to select **[Cancel]** and then **[MENU/SET]**.
 - A confirmation screen is displayed. It is executed when **[Yes]** is selected.
 - Exit the menu after it is executed.

📌 Notes

- The protect setting may not be effective on other equipment.
- Even if you protect pictures in the internal memory or a card, they will be deleted if the internal memory or the card is formatted.
- Even if you do not protect pictures on a card, they cannot be deleted when the card's write-protect switch is set to **[LOCK]**.

[Face Rec Edit]

This mode allows you to delete or change the information relating to Face Recognition for the selected picture.

- 1** Select **[Face Rec Edit]** in the **[Playback]** menu. **(P49)**
- 2** Press **▲/▼** to select **[REPLACE]** or **[DELETE]** and then **[MENU/SET]**.
- 3** Press **◀/▶** to select the picture and then **[MENU/SET]**.
- 4** Press **◀/▶** to select the person and then **[MENU/SET]**.
- 5** (When **[REPLACE]** is selected) Press **▲/▼/◀/▶** to select the person to replace and then **[MENU/SET]**.

- A confirmation screen is displayed. It is executed when **[Yes]** is selected.
Exit the menu after it is executed.

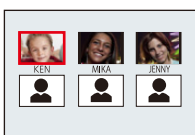

 **Notes**

- Deleted information regarding the **[Face Recog.]** function cannot be restored.
- When all Face Recognition information in a picture has been canceled, the picture will not be categorized using Face Recognition in **[Category Selection]** in **[Filtering Play]**.
- You cannot edit the Face Recognition information of protected pictures.

[Copy]

This mode allows you to copy the data of the pictures you have taken from the internal memory to a card or from a card to the internal memory.

1 Select [Copy] in the [Playback] menu. (P49)

2 Press ▲/▼ to select the copy destination and then [MENU/SET].



: All the picture data in the internal memory is copied onto the card at one time.

: One picture at a time is copied from the card to the internal memory.

3 (When [] is selected) Press ◀/▶ to select the picture and then [MENU/SET].

- A confirmation screen is displayed. It is executed when [Yes] is selected.
Exit the menu after it is executed.
- Do not turn the camera off at any point during the copying process.

 **Notes**

- If a picture exists with the same name (folder number/file number) as the picture to be copied in the copy destination when [] is selected, a new folder is created and the picture is copied. It will not be copied when [] is selected.
- It may take time to copy the picture data.
- [Print Set], [Protect] or [Favorite] settings will not be copied. Perform the settings again after copying is finished.
- Motion pictures recorded in [AVCHD] cannot be copied.

Playing Back Pictures on a TV

Pictures recorded with this camera can be played back on a TV.

Preparations: Turn the camera and the TV off.

Check the terminals on your TV and use a cable compatible with these terminals. Image quality may vary with the different terminal types.

- ❶ High quality
- ❷ HDMI socket
- ❸ Video socket



1 Connect the camera and a TV.

- Make sure the plugs are aligned correctly and that they are inserted straight. (Otherwise the connectors may be bent out of shape which may cause trouble.)

To connect with an HDMI mini cable

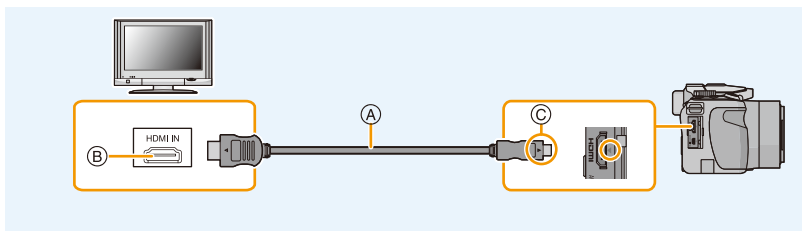

- Always use the genuine Leica HDMI mini cable (available as accessory, see [P7](#)).
- Audio will be played back as stereo (2ch).
- No picture is displayed on the screen.
- For more details about HDTV Link (HDMI) playback, refer to [P169](#).

- ❶ HDMI mini cable
- ❷ HDMI socket
- ❸ Align the marks, and insert.

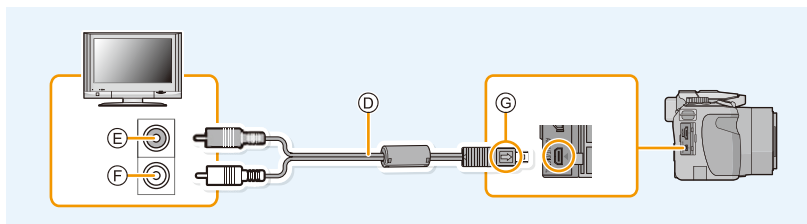
To connect with the supplied AV cable (P7)

- Always use the supplied Leica AV cable. (P7)
- Check the [TV Aspect]. (P63)
- Audio will be played back in monaural.

Ⓓ AV cable

Ⓔ White: to the audio input socket

Ⓕ Yellow: to the video input socket

Ⓖ Align the marks, and insert.

2 Turn on the TV and select the input to match the terminal in use.

3 Turn the camera on and then press [▶].

- The input of the TV will switch automatically and playback screen is displayed when connected to a HDTV Link compatible TV using the HDMI mini cable (P7) with the [HDTV Link] (P63) set to [ON]. (P169)

Notes

- Depending on the [Aspect Ratio], black bands may be displayed on the top and bottom or the left and right of the TV screen.
- Change the screen mode on your TV if the picture is displayed with the top or bottom cut off.
- Output from the HDMI mini cable has priority when both AV and HDMI mini cables are connected.
- The connection with the USB cable will take priority when you connect the USB cable simultaneously with the HDMI mini cable.
- When you play back a picture vertically, it may be blurry.
- When pictures are displayed, they may not be displayed properly depending on the type of TV.
- You can view pictures on TVs in other countries (regions) which use the NTSC or PAL system when you set [Video Out] in the [Setup] menu. (With camera model 18 190)
- No sound is output from the camera speakers.
- Read the operating instructions for the TV.

The recorded pictures can also be played back on a TV with an SD Memory Card slot.

- The appropriate playback (aspect ratio) will depend on the TV used for viewing.
- The file format of the motion pictures that can be played back differs depending on the TV model.
- In some cases, panorama pictures cannot be played back. Also, auto-scroll playback of panorama pictures may not work.
- For cards compatible with playback, refer to the instructions of the TV.

Using HDTV Link

What is HDTV Link (HDMI)?

- This function allows you to use the remote control unit of compatible TVs for easy operations when the camera has been connected to such a device using the HDMI mini cable (available as accessory, see P7) for automatic linked operations. (Not all operations are possible.)
- HDTV Link is function built on a HDMI control function using the standard HDMI CEC (Consumer Electronics Control) specification. Linked operations with some devices may not be available even if they are otherwise HDMI CEC compatible. When using devices made by other companies that are compatible with HDTV Link, refer to the operating instructions for the respective devices.

Preparations: Set the [HDTV Link] to [ON]. (P63)

- 1 Connect the camera to a HDTV Link compatible TV with the HDMI mini cable (P167).**
- 2 Turn the camera on and then press [▶].**
- 3 Operate with the remote control for the TV.**

- Operate with reference to the operation icons displayed on the screen.

Notes

- To play back the audio of the motion pictures, set the [Sound] in the Slide Show setting screen to [AUTO] or [Audio].
- It is recommended to connect the camera to an HDMI terminal other than the HDMI1 if there are 2 or more HDMI input terminals on the TV.
- Operation using the button on the camera will be limited.

■ Other linked operations

Turning the camera off:

If you use the remote control for the TV to turn the TV off, the camera is also turned off.

Automatic input switching:

- If you connect with the HDMI mini cable and then turn the camera on, and then press **[▶]**, the input channel on the TV automatically switches to the camera's screen. If the TV's power is in standby status, it will turn on automatically (if **[Set]** has been selected for the TV's **[Power on link]** setting).
- Depending on the HDMI terminal on the TV, the input channel may not switch automatically. In this case, use the remote control for the TV to switch the input channel. (For details on how to switch input, please read the instructions for the TV.)
- If HDTV Link does not work properly, refer to page [199](#).

Notes

- If you are unsure whether or not the TV you are using are compatible with HDTV Link, read the instructions for the TV.
- Available linked operations between the camera and a TV is different depending on the types TVs even if they are compatible with HDTV Link. Refer to the instructions of the TV for the operations that support on the TV.
- Always use the genuine Leica HDMI mini cable (available as accessory, see [P7](#)).

Playing back 3D pictures

Connecting the camera to a 3D compatible television and playing back pictures taken in 3D allows you to enjoy 3D pictures for extra impact.

It is also possible to play back the recorded 3D pictures by inserting an SD card into the 3D compatible television with an SD card slot.

Preparations: Set the [3D Playback] to [3D]. (P63)

Connect the camera to a 3D compatible television using the HDMI mini cable (available as accessory, see P7) and display the playback screen. (P167)

- When [HDTV Link] (P63) is set to [ON] and the camera is connected to a TV supporting HDTV Link, the input of the TV will be switched automatically and the playback screen will be displayed. Refer to P169 for details.
- For the pictures recorded in 3D, [3D] will appear on the thumbnail display at playback.

■ Play back as a 3D slide show by selecting only the still pictures recorded in 3D

Select [3D Play] in [Slide Show] in the Playback Mode. (P149)

■ Play back in 3D by selecting only the still pictures recorded in 3D

Select [3D Play] in [Filtering Play] in the Playback Mode. (P152)

■ Switch the playback method for the still pictures recorded in 3D

1 Select the picture recorded in 3D.

2 Select [2D/3D Settings] on the [Playback Mode] menu and then press [MENU/SET]. (P49)

- The playback method will switch to 3D if it is playing back in 2D (conventional image).
- If you feel tired, uncomfortable or otherwise strange when playing back pictures recorded in 3D, set to 2D.

 **Notes**

- When the picture is not appropriate to view in 3D (disparity is too large, etc.)
 - [Slide Show]:
The picture will be played back in 2D.
 - [Filtering Play]:
A confirmation screen is displayed. Select whether or not to play back the picture in 3D.
- 2 pictures may be displayed side by side when a 3D picture is played back on a TV that is not 3D compatible.
- When a picture recorded in 3D is displayed on the screen of the camera, it is played back in 2D (conventional image).
- A black screen is displayed for a few seconds when switching back and forth playback of 3D pictures and 2D pictures.
- When you select a 3D picture thumbnail, it may take a few seconds for playback to start. After playback, the thumbnail display may take a few seconds to reappear.
- When viewing 3D pictures, your eyes may become tired if you are too close to the television screen.
- If your television does not switch to a 3D picture, make the necessary settings on the TV. (For details, refer to the instructions of the TV.)
- The following functions cannot be used during the 3D playback.
 - [Setup] menu
 - [Playback] menu
 - Playback Zoom
 - Deleting pictures

Saving still and motion pictures on your computer

You can copy recorded pictures to a computer by connecting it to the camera.

- Some computers can read directly from the card removed from the camera. For details, refer to the instructions of your computer.
- **If the computer being used does not support SDXC Memory Cards, a message prompting you to format may appear. (Doing so will cause recorded images to be erased so do not choose to format.)**

■ Computers that can be used

The camera can be connected to any computer capable of recognizing a mass storage device.

- Windows support: Windows 7/Windows Vista/Windows XP
- Mac support: OS X v10.1 ~ v10.7

AVCHD motion pictures may not be imported correctly when copied as files or folder.

- With Windows, always import AVCHD motion pictures using the available software.
(Read the "Basic Instructions" for more information about the available software)
- With a Mac, AVCHD motion pictures can be imported using "iMovie'11".

Note that motion pictures (AVCHD Progressive) recorded in [PSH] cannot be imported.
(For details about iMovie'11, please contact Apple Inc.)

Preparations: Install the available software to the computer.

- Follow the instructions of the installer of the software.

The available software can be used to save all the still and motion pictures recorded by the camera in their various formats to your computer.



1 Connect the camera to a computer via the supplied USB cable (A).

- Please turn the camera on and your computer before connecting.
- Do not use any other USB cables except the supplied one. Use of cables other than the supplied one may cause malfunction.
- Make sure the plug is aligned correctly and that it is inserted straight.
(Otherwise the connectors may be bent out of shape which will cause trouble.)

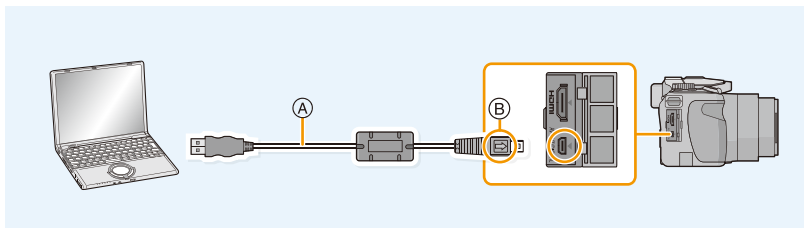

- (A) USB cable
- (B) Align the marks, and insert.

2 Press ▲/▼ to select [PC], and then [MENU/SET].

- If [USB Mode] (P62) is set to [PC] in the [Setup] menu in advance, the camera will be automatically connected to the computer without displaying the [USB Mode] selection screen.
- When the camera has been connected to the computer with [USB Mode] set to [PictBridge(PTP)], a message may appear on the computer's screen. Close the screen by selecting [Cancel], safely remove the USB cable (P176), and set the [USB Mode] to [PC].

3 Copy the images to a computer using the available software.

- You will not be able to play back the acquired [AVCHD] motion pictures when the files or folders related to the motion pictures are deleted, modified, or moved using Windows Explorer or similar, so make sure to acquire the [AVCHD] motion pictures using the downloaded software.

Notes

- Use a battery with sufficient capacity. If the remaining battery power becomes low while the camera and the computer are communicating, the status indicator flashes and the alarm beeps. Refer to “Disconnecting the USB cable safely” (P176) before disconnecting the USB cable. Otherwise, data may be destroyed.
- Before inserting or removing a card, turn the camera off and disconnect the USB cable. Otherwise, data may be destroyed.

Copying to a computer without using the available software

If you are not able to install the available software, you can copy files and folders to your computer by dragging and dropping files from the camera.

Directory structure of internal memory/card of the camera

For Windows: A drive ([Removable Disk]) is displayed in [Computer]

For Mac: A drive ([LEICA], [NO_NAME] or [Untitled]) is displayed on the desktop

Internal Memory

Card

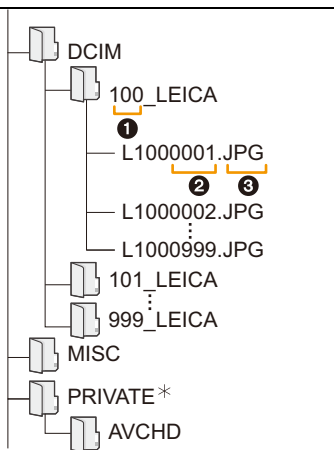

DCIM:

- ❶ Folder number
- ❷ File number
- ❸ JPG:

Images

- MP4: [MP4] Motion pictures
- RWL: Pictures in RAW files
- MPO: 3D pictures

MISC:

DPOF print
Favorite

AVCHD:

[AVCHD] Motion pictures

* Cannot be created in the internal memory.

- AVCHD motion pictures may not be imported correctly when copied as files or folder. We recommend using the available software for importing files. Refer to P173 for details.
- A new folder is created when pictures are taken in the following situations.
 - After [No.Reset] (P61) in the [Setup] menu has been executed
 - When a card containing a folder with the same folder number has been inserted (such as when pictures were taken using another maker of camera)
 - When there is a picture with file number 999 inside the folder

■ Disconnecting the USB cable safely

Select the  icon in the tray displayed on the computer, and then click [Eject V-LUX 4].

- Depending on your computer's settings, this icon may not be displayed.
- If the icon is not displayed, check that [Access] is not displayed on the monitor of the camera before removing the hardware.

■ Connection in the PTP Mode

Set [USB Mode] to [PictBridge(PTP)].

- Data can now be read only from the camera into the computer.
- When there are 1000 or more pictures on a card, the pictures may not be imported in the PTP Mode.
- Motion pictures cannot be played back in PTP Mode.

Saving still and motion pictures on a Recorder

■ Dubbing with non-compatible equipment

You can dub the content played back using the camera to non-compatible equipment such as recorders and video players by connecting the camera to the non-compatible equipment using the supplied AV cable. Non-compatible equipment will be able to play back the content. This is convenient if you wish to pass around dubbed content. In this case, the content will be played back in standard rather than high-definition picture quality.

1 Connect the camera with the recording equipment with the supplied AV cable.

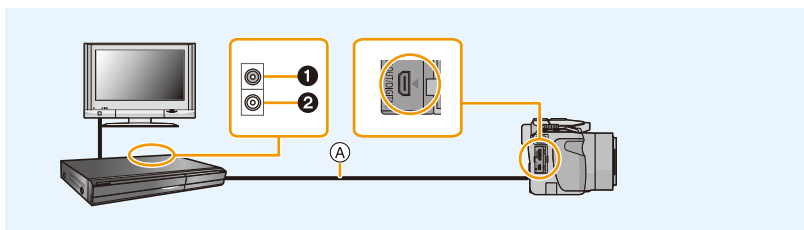

- ① Yellow: to the video input socket
- ② White: to the audio input socket
- Ⓐ AV cable

2 Start the playback of the camera.

3 Start the recording on the recording equipment.

- When ending the recording (copying), stop the playback on the camera after stopping the recording in recording equipment.

📌 Notes

- When you play back motion pictures on a 4:3 aspect ratio TV, you must set [TV Aspect] (P63) on the camera to [4:3] before starting a copy. The image will be cut off at the left and right edges if you play back motion pictures copied with [16:9] setting on a [4:3] aspect TV.
- See the instructions for the recording equipment about the details of copying and playing back.

Printing the Pictures

If you connect the camera to a printer supporting PictBridge, you can select the pictures to be printed out and instruct that printing be started on the camera's monitor.

- Picture series will be displayed as a list, and not as a group.
- Some printers can print directly from the card removed from the camera. For details, refer to the instructions of your printer.

Preparations:

Turn on the camera and the printer.

Remove the card before printing the pictures in the internal memory.

Perform the print quality and other settings at the printer before printing the pictures.

1 Connect the printer and camera with the supplied USB cable.

- Make sure the plugs are aligned correctly and that they are inserted straight. (Otherwise the connectors may be bent out of shape which may cause trouble.)
- Do not use any other USB cables except the supplied one. Use of cables other than the supplied one may cause malfunction.

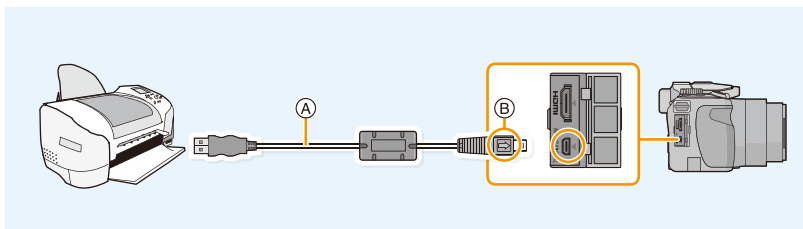

- (A) USB cable
- (B) Align the marks, and insert.

2 Press ▲/▼ to select [PictBridge(PTP)], and then [MENU/SET].

Notes

- Use a battery with sufficient capacity. If the remaining battery power becomes low while the camera and the printer are connected, the status indicator flashes and the alarm beeps. If this happens during printing, stop printing at once. If not printing, disconnect the USB cable.
- Do not disconnect the USB cable while [] (Cable disconnect prohibit icon) is displayed. (may not be displayed depending on the type of printer used)
- Before inserting or removing a card, turn the camera off, and disconnect the USB cable.
- Motion pictures recorded cannot be printed out.

Selecting a single picture and printing it

1 Press **◀/▶** to select the picture and then **[MENU/SET]**.



2 Press **▲** to select **[Print start]** and then **[MENU/SET]**.

- Refer to [P180](#) for the items which can be set before starting to print the pictures.
- Disconnect the USB cable after printing.

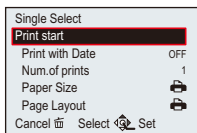

Selecting multiple pictures and printing them

1 Press **▲**.

2 Press **▲/▼** to select an item and then **[MENU/SET]**.

Item	Description of settings
[Multi Select]	Multiple pictures are printed at one time. • Press ▲/▼/◀/▶ to select the pictures, and then [DISP.] . (When [DISP.] is pressed again, the setting is canceled.) • After the pictures have been selected, press [MENU/SET] .
[Select All]	Prints all the stored pictures.
[Print Set (DPOF)]	Prints the pictures set in [Print Set] only. (P162)
[Favorite]	Prints the pictures set as favorites only. (P161)

3 Press **▲** to select **[Print start]** and then **[MENU/SET]**.

- If the print check screen has appeared, select **[Yes]**, and print the pictures.
- Refer to [P180](#) for the items which can be set before starting to print the pictures.
- Disconnect the USB cable after printing.

Print Settings

Select and set the items both on the screen in step 2 of the “Selecting a single picture and printing it” and in step 3 of the “Selecting multiple pictures and printing them” procedures.

- When you want to print pictures in a paper size or a layout which is not supported by the camera, set [Paper Size] or [Page Layout] to  and then set the paper size or the layout on the printer. (For details, refer to the instructions of the printer.)
- When [Print Set (DPOF)] has been selected, the [Print with Date] and [Num.of prints] items are not displayed.

[Print with Date]

Item	Description of settings
[ON]	The date is not printed.
[OFF]	The date is printed.

- If the printer does not support date printing, the date cannot be printed on the picture.
- Depending on the printer, the date print settings of the printer may take precedence so check if this is the case.
- When printing images with [Date Stamp] or [Text Stamp], please remember to set [Print with Date] to [OFF] or the date will print on top.



Notes

When asking the photo shop to print the pictures

- By stamping the date using [Date Stamp] (P140) or [Text Stamp] (P155) or setting date printing at the time of the [Print Set] (P162) setting before going to a photo shop, the dates can be printed at the photo shop.

[Num.of prints]





You can set the number of prints up to 999.

[Paper Size]

Item	Description of settings
	Settings on the printer are prioritized.
[L/3.5"×5"]	89mm×127mm
[2L/5"×7"]	127mm×178mm
[POSTCARD]	100mm×148mm
[16:9]	101.6mm×180.6mm
[A4]	210mm×297mm
[A3]	297mm×420mm
[10×15cm]	100mm×150mm
[4"×6"]	101.6mm×152.4mm
[8"×10"]	203.2mm×254mm
[LETTER]	216mm×279.4mm
[CARD SIZE]	54mm×85.6mm

• Paper sizes not supported by the printer will not be displayed.

[Page Layout] (Layouts for printing that can be set with the camera)

Item	Description of settings
	Settings on the printer are prioritized.
	1 picture with no frame on 1 page
	1 picture with a frame on 1 page
	2 pictures on 1 page
	4 pictures on 1 page

- An item cannot be selected if the printer does not support the page layout.

■ Layout printing**When printing a picture several times on 1 sheet of paper**

For example, if you want to print the same picture 4 times on 1 sheet of paper, set [Page Layout] to  and then set [Num.of prints] to 4 for the picture that you want to print.

When printing different pictures on 1 sheet of paper

For example, if you want to print 4 different pictures on 1 sheet of paper, set [Page Layout] to  and then set [Num.of prints] to 1 for each of the 4 pictures.

 Notes



- The camera is receiving an error message from the printer when the  indication lights up in orange during printing. After finishing printing, make sure there are no problems with the printer.
- If the number of prints is high, the pictures may be printed several times. In this case, the remaining number of prints indicated may differ from the number set.
- When the pictures in RAW files are to be printed, the JPEG pictures recorded simultaneously by the camera will be printed. If JPEG pictures do not exit, RAW file pictures cannot be printed.

Screen Displays

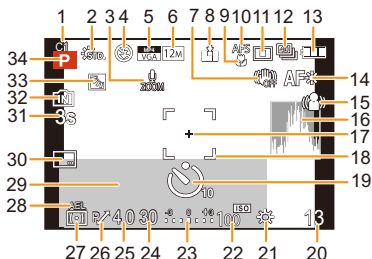

In recording

- 1 Custom Settings (P121)
- 2 Photo Style (P127)
Color Mode (P35)
☞ : Creative control adjustment display (P112)
- 3 Zoom Microphone (P144)
- 4 Flash Mode (P72)
Flash Exposure Compensation (P138)
- 5 Recording mode (for recording motion pictures) (P141)
Recording quality (P142)
- 6 Resolution (P129)
- 7 Stabilizer Off (P136)
☞ : Camera Shake Alert (P26)
- 8 Quality (P130)
- 9 AF Macro Mode (P92)
- 10 AF Style (P132)
MF : MF (P93)
AFL : AF lock (P96)
- 11 AF Mode (P88)
- 12 Continuous Mode (P77)
☞ : Auto Bracketing (P139)
- 13 Battery Indication (P16)
- 14 AF Assist Lamp (P137)
Focus (P30)
- 15 Motion Deblur (P35)
- 16 Histogram (P57)
- 17 Spot Metering target mark (P133)
- 18 AF frame (P30)
- 19 Self-timer Mode (P80)
- 20 Number of recordable pictures (P22)
Available recording time (P23): R8m30s*
- 21 White Balance (P84)
White Balance Fine Adjustment (P86)
BKT: White Balance Bracketing (P87)
- 22 ISO Sensitivity (P82)
ISO Limit Set (P131)
- 23 Exposure compensation value (P76)/Light balance (P101)
Zoom (P68): EZ i.ZOOM W [] T 1X
- 24 Shutter speed (P28)
☞ : Minimum Shutter Speed (P134)
- 25 Aperture value (P28)
- 26 Program Shift (P29)
- 27 Metering Mode (P133)



- 28 AE lock (P96)
 - 29 Current date and time/: World Time (P52)
Number of days that have passed since the departure date (P53)
Location (P53)
Name (P109)
Age (P109)
Shutter speed/aperture combination (P58)
 - 30 Date Stamp (P140)
 - 31 Elapsed Recording Time (P38): 8m30s*
 - 32 Internal memory (P20)
: Card (P20) (displayed only during recording)
 - 33 Backlight Compensation (P34)
 - 34 Recording mode (P27)
- * “m” is an abbreviation for minute and “s” for second.

■ In playback

- 1 Playback Mode (P149)
- 2 Protected Picture (P164)
- 3 Favorites (P161)
- 4 Date/Text stamped display (P140, 155)
- 5 Photo Style (P127)
- Color Mode (P35)
- 6 After Auto Retouch (P145)
- After Creative Retouch (P146)
- 7 Resolution (P129)
- 8 Quality (P130)
- 9 Battery Indication (P16)
- 10 Internal Memory (P20)
- Elapsed playback time (P44): 8m30s *
- 11 Picture Number/Total Pictures
- 12 Folder/File Number (P175)
- 13 Histogram (P57)
- 14 Picture Series Group Display (P147)
- 15 Location (P53)
- Recording information (P67)
- Name (P109)
- Age (P109)
- Title (P154)
- Number of days that have passed since the departure date (P53)
- Recorded date and time
- ✈: World Time (P52)
- 16 Motion picture recording time (P44): 8m30s *
- Number of pictures in a picture series group (P148)
- 17 Auto Retouch (P145)
- Creative Retouch (P146)
- Motion picture playback (P44)
- Play panorama (P105)
- Continuously Picture Series Group Playback (P147)
- 18 Currently retrieving information icon (P192)
- 19 Number of Prints (P162)
- 20 Recording Quality (P142)
- : High Speed Motion Picture Playback (P119)
- : Picture Series Group icon (P147)
- Cable disconnection warning icon (P178)

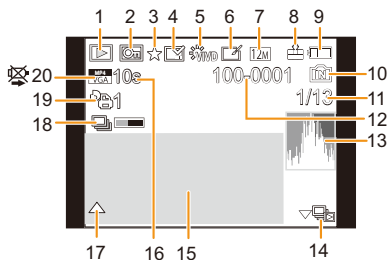

* "m" is an abbreviation for minute and "s" for second.

Cautions for Use

Optimal use of the camera

Keep the camera as far away as possible from electromagnetic equipment (such as microwave ovens, TVs, video games etc.).

- If you use the camera on top of or near a TV, the pictures and/or sound in the camera may be disrupted by electromagnetic fields.
- Do not use the camera near cell phones because doing so may result in noise adversely affecting the pictures and/or sound.
- Recorded data may be damaged, or pictures may be distorted, by strong magnetic fields created by speakers or large motors.
- Electromagnetic fields generated by microprocessors may adversely affect the camera, disturbing the pictures and/or sound.
- If the camera is adversely affected by electromagnetic equipment and stops functioning properly, turn it off and remove the battery. Then reinsert the battery and turn the camera on.

Do not use the camera near radio transmitters or high-voltage lines.

- If you record near radio transmitters or high-voltage lines, the recorded pictures and/or sound may be adversely affected.

Always use the supplied cords and cables. If you use optional accessories, use the cords and the cables supplied with them.

Do not extend the cords or the cables.

Do not spray the camera with insecticides or volatile chemicals.

- If the camera is sprayed with such chemicals, its body may be damaged and the surface finish may peel off.
- Do not keep rubber or plastic products in contact with the camera for a long period of time.

Cleaning

Before cleaning the camera, remove the battery. Then wipe the camera with a dry soft cloth.

- When the camera is soiled badly, it can be cleaned by wiping the dirt off with a wrung wet cloth, and then with a dry cloth.
- Do not use solvents such as benzine, thinner, alcohol, kitchen detergents, etc., to clean the camera, since it may deteriorate the external case or the coating may peel off.
- When using a chemical cloth, be sure to follow the accompanying instructions.

About the monitor/Viewfinder

- Do not press the monitor with excessive force. Uneven colors may appear on it and it may malfunction.
- If the camera is cold when you turn it on, the picture on the monitor/Viewfinder will be slightly darker than usual at first. However, the picture will return to normal brightness when the internal temperature of the camera increases.

Extremely high precision technology is employed to produce the monitor/viewfinder screen. However there may be some dark or bright spots (red, blue or green) on the screen. This is not a malfunction. The monitor/viewfinder screen has more than 99.99% effective pixels with a mere 0.01% of the pixels inactive or always lit. The spots will not be recorded on pictures on the internal memory or a card.

About the Lens

- Do not press the lens with excessive force.
- Do not leave the camera with the lens facing the sun as rays of light from the sun may cause it to malfunction. Also, be careful when placing the camera outside or near a window.
- When there is dirt (water, oil, and fingerprints, etc.) on the surface of the lens, the picture may be affected. Lightly wipe the surface of the lens with a soft, dry cloth before and after taking pictures.
- Retract the lens when carrying the camera.

Battery

The battery is a rechargeable lithium ion unit. Its ability to generate power comes from the chemical reaction that takes place inside it. This reaction is susceptible to the surrounding temperature and humidity. If the temperature is too high or too low, the operating time of the battery will become shorter.

Always remove the battery after use.

- Place the removed battery in a plastic bag, and store or carry away from metallic objects (clips, etc.).

If you drop the battery accidentally, check to see if its body and the terminals are damaged.

- Inserting a damaged battery in the camera will damage the camera.

Take along charged spare batteries when going on longer excursions.

- Be aware that the operating time of the battery becomes shorter in low temperature conditions such as at a ski resort.
- When you travel, do not forget to take along the battery charger (supplied) so that you can charge the battery in the country that you are traveling in.

Dispose of unusable battery.

- The battery has a limited life.
- Do not throw the battery into fire because it may cause an explosion.

Do not allow battery terminals to come into contact with metal objects (such as necklaces, hairpins etc.).

- This can cause short circuiting or heat generation and you may be badly burned if you touch such a battery.

Charger

- The [CHARGE] indicator may blink under the influence of static electricity or electromagnetic fields. This phenomenon has no effects on charging.
- If you use the battery charger near a radio, the radio reception may be disturbed.
- Keep the charger approx 1m / 3'3" or more away from radios.
- The charger may generate whirring sounds when it is being used. This is not a malfunction.
- After use, be sure to disconnect the power supply device from the electrical outlet. (A very small amount of current is consumed if it is left connected.)
- Keep the terminals of the charger and battery clean.

About 3D

■ About 3D viewing

Anyone who is hyper sensitive to light, suffers from heart disease or is otherwise unwell should avoid viewing 3D contents.

- Viewing 3D contents may have an adverse effect to the individual.

If you feel tired, uncomfortable or otherwise strange when viewing 3D contents, stop viewing at once.

- Continuing to view may cause illness.
- After stopping viewing, please rest appropriately.

When viewing 3D contents, we recommend taking a break every 30 to 60 minutes.

- Viewing for extended periods may cause eye-fatigue.

Short-sighted or long-sighted persons, those with differences in the sight of their right and left eyes, and those with astigmatism are advised to correct their vision by wearing glasses etc.

Stop viewing if you can clearly see a double image while viewing 3D contents.

- There are differences in the way that different people experience 3D contents. Please correct your sight appropriately before viewing 3D contents.
- You can change the 3D setting of your television or 3D output setting of the camera to 2D.

Card

Do not leave the card where the temperature is high, where electromagnetic fields or static electricity are easily generated or exposed to direct sunlight.

Do not bend or drop the card.

- The card may be damaged or the recorded content may be damaged or deleted.
- Put the card in the card case or the storage bag after use and when storing or carrying the card.
- Do not allow dirt, dust or water to get into the terminals on the back of the card and do not touch the terminals with your fingers.

Notice for when transferring to another party, or disposing of the memory card

- "Format" or "delete" using the camera or a computer will only modify the file management information, and it will not erase the data in the memory card completely.

It is recommended to physically destroy the memory card or use the commercially available computer data deletion software to completely erase the data in the memory card before transferring to another party or disposing.

Management of data in the memory card is the responsibility of the user.

About the personal information

If a name or birthday is set for [Baby1]/[Baby2]/Face Recognition function, this personal information is kept in the camera and recorded in the image.

Disclaimer

- Information including personal information may be altered or vanish due to erroneous operation, effect of static electricity, accident, malfunction, repair, or other handlings.
- Please note in advance that Leica Camera AG is not liable in any way for any direct or indirect damage from the alteration or vanishing of information or personal information.

When requesting a repair, transferring to another party or disposing

- Reset the settings to protect the personal information. (P62)
- If there are pictures stored in the internal memory, copy them onto the memory card (P166) before formatting the internal memory (P65) as needed.
- Remove the memory card from the camera when requesting a repair.
- The internal memory and settings may return to factory default when the camera is repaired.
- Please contact the dealer where you purchased the camera or your nearest Leica Customer Care center (P203) if above operations are not possible due to malfunction.

When transferring to another party, or disposing of the memory card, please refer to “Notice for when transferring to another party, or disposing of the memory card” on P188.

When not using the camera for a long period of time

- Store the battery in a cool and dry place with a relatively stable temperature: [Recommended temperature: 15°C to 25°C (59°F to 77°F), Recommended humidity: 40%RH to 60%RH]
- Always remove the battery and the card from the camera.
- If the battery is left inserted in the camera, it will discharge even if the camera is turned off. If the battery continues to be left in the camera, it will discharge excessively and may become unusable even if charged.
- When storing the battery for a long period of time, we recommend charging it once a year. Remove the battery from the camera and store it again after it has completely discharged.
- We recommend storing the camera with a desiccant (silica gel) when you keep it in a closet or a cabinet.

About the picture data

- Recorded data may be damaged or lost if the camera breaks down due to inappropriate handling. Leica Camera AG will not be liable for any damage suffered due to loss of recorded data.

About tripods or unipods

- When you use a tripod, make sure the tripod is stable when the camera is attached to it.
- You may not be able to remove the card or the battery when using a tripod or unipod.
- Make sure that the screw on the tripod or unipod is not at an angle when attaching or detaching the camera. You may damage the thread in the camera if you use excessive force when turning it. Also, the camera body and the rating label may be damaged or scratched if the camera is attached too tightly to the tripod or unipod.
- Read the instructions for the tripod or unipod carefully.

Message Displays

Confirmation or error messages will be displayed on the screen in some cases. The major messages are described below as examples.

[This picture is protected]

→ Delete the picture after canceling the protect setting. (P164)

[This picture cannot be deleted]/[Some pictures cannot be deleted]

- Pictures not based on the DCF standard cannot be deleted.
 - If you want to delete some pictures, format the card after saving necessary data on a computer etc. (P65)

[Cannot be set on this picture]

- [Title Edit], [Text Stamp] or [Print Set] cannot be set for pictures not based on the DCF standard.

[Built-in memory full]/[Memory card full]/[Not enough space on built-in memory]/[Not enough memory on the card]

- There is no space left in the internal memory or the card.
- When you copy pictures from the internal memory to the card (batch copy), the pictures are copied until the capacity of the card is depleted.

[Some pictures cannot be copied]/[Copy could not be completed]

- The following pictures cannot be copied.
 - When a picture with the same name as the picture to be copied exists in the copy destination. (Only when copying from a card to the internal memory.)
 - Files not based on the DCF standard.
- Moreover, pictures recorded or edited by other equipment may not be copied.

[Built-In Memory Error Format built-in memory?]

- This message will be displayed when you formatted the internal memory on a computer.
 - Format the internal memory on the camera again. (P65) The data in the internal memory will be deleted.

[Memory card error.**This card cannot be used in this camera.****Format this card?]**

- It is a format that cannot be used with this camera.
 - Insert a different card.
 - Format the card again with the camera after saving necessary data on a computer etc. (P65)
The data on the card will be deleted.

[Please turn camera off and then on again]/[System Error]

- This is displayed when the lens has stopped operating normally due to being pressed on by a hand etc.
 - Turn the camera off and on. If the message persists, contact the dealer or your nearest Leica Customer Care center (P203).

[Memory Card Error]/[Memory card parameter error]/[This memory card cannot be used]

- Use a card compatible with the camera. (P21)
- SD Memory Card (8MB to 2GB)
- SDHC Memory Card (4GB to 32GB)
- SDXC Memory Card (48GB, 64GB)

[Insert SD card again]/[Try another card]

- An error has occurred accessing the card.
 - Insert the card again.
 - Insert a different card.

**[Read Error/Write Error
Please check the card]**

- It has not been possible to read or write data.
 - Remove the card after turning the camera off. Insert the card again, turn the camera on, and try to read or write the data again.
- The card may be broken.
 - Insert a different card.

[Motion recording was cancelled due to the limitation of the writing speed of the card]

- Use a card with SD Speed Class with “Class 4” or higher when recording motion pictures.
- In the event that it stops even after using a “Class 4” card or higher, the data writing speed has deteriorated so it is recommended to make a backup and then format (P65).
- Depending on the type of the card, motion picture recording may stop in the middle.

[Cannot record due to incompatible format(NTSC/PAL) data on this card.]

- If you want to delete some pictures, format the card after saving necessary data on a computer etc. (P65)
- Insert a different card.

[A folder cannot be created]

- A folder cannot be created because there are no remaining folder numbers that can be used.
 - Format the card after saving necessary data on a computer etc. (P65) If you execute [No.Reset] in the [Setup] menu after formatting, the folder number is reset to 100. (P61)

[Picture is displayed for 16:9 TV]/[Picture is displayed for 4:3 TV]

- Select [TV Aspect] in the [Setup] menu if you want to change the TV aspect ratio. (P63)
- This message also appears when the USB cable is connected to the camera only.
 - In this case, connect the other end of the USB cable to a computer or a printer. (P174, 178)

[Editing operation cannot proceed as information processing is ongoing.]

When a card with pictures deleted or file names changed using a computer or other device is inserted into the camera, it will automatically retrieve new information and reconstruct the picture series groups. The currently retrieving information icon  may be displayed in the playback screen for long period of time when there are many image files, and deletion or [Playback] menu cannot be used during this time.

- If you turn the camera off while information is being retrieved, the pictures for which information was retrieved up to that point will be saved as a picture series group. When you switch on again, the information retrieval will restart from the same point.

[Recording failed.]

- You may not be able to record when the recording location is too dark/too bright, or if the subject does not have enough contrast when recording in 3D.

[This battery cannot be used]

- Use a genuine Leica battery. If this message is displayed even when a genuine Leica battery is used, contact the dealer or your nearest Leica Customer Care center (P203).
- If the battery terminal is dirty, clean it and remove any objects.

[Please make sure to turn on the power of external microphone.]

- When attaching an external stereo microphone (optionally available from other suppliers), check the battery status and make sure the power is on before use.

Troubleshooting

First, try out the following procedures (P193 to 202).

If the problem is not resolved, it may be improved by selecting [Reset] (P62) on the [Setup] menu.

Battery and power source

The camera cannot be operated even when it is turned on.

The camera turns off immediately after it is turned on.

- The battery is exhausted. Charge the battery.
- If you leave the camera on, the battery will be exhausted.
 - Turn the camera off frequently by using the [Economy] mode etc. (P60)

The camera is turned off automatically.

- If you connect to a TV compatible with HDTV Link with the HDMI mini cable (available as accessory, see P7) and turn the TV off with the remote control for the TV, the camera is also turned off.
 - If you are not using HDTV Link, set [HDTV Link] to [OFF]. (P63)

Card/battery door does not close.

- Insert the battery correctly all the way in.

Recording

The picture cannot be recorded.

- Is the mode dial correctly set?
- Is there any memory remaining in the internal memory or the card?
 - Delete unnecessary pictures to increase the available memory. (P46)
- You may not be able to record for a short while after turning the camera on when using a large capacity card.

The recorded picture is whitish.

- The picture can become whitish if there is dirt e.g. fingerprints on the lens.
 - If the lens is dirty, turn the camera off, retract the lens barrel and gently wipe the lens surface with a soft dry cloth.

The recorded picture is too bright or dark.

- Check that the exposure is set correctly for the important parts of the subject. Using AE-lock or exposure compensation may help in case of off-center and/or overly dark or bright subjects. (P76)

Multiple pictures are taken at one time.

- Cancel the settings of White Balance Bracketing (P87).
- Set Auto Bracketing (P139) or the Continuous Mode (P77) to [OFF].
- Is the Self-Timer (P80) set to [10s / 3pictures]?

The subject is not focused properly.

- The focus range varies depending on the recording mode.
 - Set to the proper mode for the distance to the subject.
- The subject is beyond the focus range of the camera. (P31)
- There is camera shake or the subject is moving slightly. (P26)

The recorded picture is blurred.**The Optical Image Stabilizer is not effective.**

- The shutter speed becomes slower when pictures are taken in dark places so hold the camera steady with both hands to take the pictures. (P26)
- When taking pictures at a slow shutter speed, use the Self-timer. (P80)

Taking pictures using Auto Bracketing is not possible.

- Is there any memory remaining in the internal memory or the card?

The recorded picture looks rough.**Noise appears on the picture.**

- Is the ISO sensitivity high or the shutter speed slow? (ISO sensitivity is set to [AUTO] when the camera is shipped. Therefore, when taking pictures indoors etc. noise will appear.)
 - Decrease the ISO sensitivity. (P82)
 - Increase the setting for [Noise Reduction] in [Photo Style] or lower the setting for each of the items other than [Noise Reduction]. (P128)
 - Take pictures in bright places.
- Has [High Sens.] in the Scene Mode been set? If so, the resolution of the recorded picture decreases slightly because of high sensitivity processing, but this is not a malfunction.

Striping or flicker may appear under lighting such as fluorescent lighting and LED lighting.

- This is characteristic of MOS sensors like the one in this camera. This is not a malfunction.



The brightness or the hue of the recorded picture is different from the actual scene.

- When recording under fluorescent or LED lighting etc., increasing the shutter speed may introduce slight changes to brightness and color. These are a result of the characteristics of the light source and do not indicate a malfunction.
- When recording subjects in extremely bright locations or recording under fluorescent or LED lighting, mercury lamps, sodium lighting etc., the colors and the monitor brightness may change or horizontal striping may appear on the monitor.

Reddish horizontal streaks appear on the monitor during recording.

- This is characteristic of MOS sensors like the one in this camera. It appears when the subject has a bright part. Some unevenness may occur in the surrounding areas, but this is not a malfunction. It is recorded in still and motion pictures.
- It is recommended that you take pictures while taking care not to expose the screen to sunlight or any other source of strong light.



Motion picture recording stops by itself.

- Use a card with SD Speed Class with “Class 4” or higher when recording motion pictures.
- Depending on the type of the card, recording may stop by itself.
 - If motion picture recording stops during use of a card of at least “Class 4” or if you use a card that has been formatted on a computer or other equipment, the data-writing speed is lower. In such cases, we recommend that you make a backup of the data and then format (P65) the card in this camera.

Subject is rendered slightly distorted.

- The subject is rendered slightly distorted when it moves across the image very fast, but this is because the camera uses a MOS image sensor. This is not a malfunction.

The zoom cannot be controlled with the zoom/focus rocker.

- Has [Side Lever] (P54) been set to [FOCUS]?
 - Set [Side Lever] to [ZOOM].

Subject cannot be locked. (AF tracking not possible)

- Point the AF frame at a distinctive color within the subject if there has a part that is different color than the surrounding area. (P90)

Recording by [Panorama Shot] is ended before finishing.

- If the camera is moved too slowly, it assumes that the camera motion was stopped and will end the still picture recording.
- If there is a great deal of shaking towards the recording direction while moving the camera, recording will end.
 - When recording with [Panorama Shot], move the camera by trying to trace a small circle parallel to the recording direction at a speed of about 8 seconds per revolution (estimated).

Monitor/Viewfinder

The monitor/viewfinder becomes darker or brighter for a moment.

- This phenomenon appears when you press the shutter release button halfway to set the aperture value and does not affect the recorded pictures.
- This phenomenon also appears when the brightness changes when the camera is zoomed or when the camera is moved. This is because of operation of the automatic aperture of the camera, and it is not a malfunction.

The monitor flickers indoors.

- The monitor may flicker for a few seconds after the camera is turned on. This is an operation to correct flicker caused by lighting such as fluorescent lights, LED lights etc. and is not a malfunction.

The monitor/viewfinder is too bright or dark.

- Check [LCD Mode] setting. (P55)
- Perform [LCD Display]/[Viewfinder]. (P55)

The picture is not displayed on the monitor.

- Does the picture appear in the viewfinder?
→ Press [EVF/LCD] button to switch to monitor display.

Black, red, blue and green dots appear on the monitor.

- This is not a malfunction.
These pixels do not affect the recorded pictures.

Noise appears on the monitor.

- In dark places, noise may appear to maintain the brightness of the monitor. This does not affect the pictures you are recording.

Flash

The flash is not fired.

- Is the flash closed?
 - Open the flash. (P72)
- The flash cannot be used in the following cases:
 - When using Auto Bracketing (P139)
 - When recording in [Burst] (except for [3]) (P77)
 - [Scenery]/[Panorama Shot]/[Night Scenery]/[Handheld Night Shot]/[HDR]/[Sunset]/[Glass Through]/[3D Photo Mode] (Scene Mode) (P102)

The flash is activated several times.

- The flash is activated twice when Red-Eye Reduction (P73) has been set.
- Is Continuous Mode set to []?

Playback

The picture being played back is rotated and displayed in an unexpected direction.

- [Rotate Disp.] (P64) is set to [] or [].

The picture is not played back. There are no recorded pictures.

- Is there a picture in the internal memory or the card?
 - The pictures in the internal memory appear when a card is not inserted. The picture data on the card appears when a card is inserted.
- Is this a folder or picture which was processed in a computer? If it is, it cannot be played back by the camera.
- Has [Filtering Play] been set for playback?
 - Change to [Normal Play]. (P149)

The folder number and the file number are displayed as [—] and the monitor turns black.

- Is this a non-standard picture, a picture which has been edited using a computer or a picture which was taken by another make of digital camera?
- Did you remove the battery immediately after picture-taking or did you take the picture using a battery with a low remaining charge?
→ Format the data to delete the pictures mentioned above. (P65)
(Other pictures will be deleted as well and it will not be possible to restore them. Therefore, check well before formatting.)

With a Calendar Search, pictures are displayed on dates differing from the actual dates on which the pictures were taken.

- Is the clock in the camera set properly? (P24)
- When pictures edited using a computer or pictures taken by other equipment are searched, they may be displayed on dates differing from the actual dates on which the pictures were taken.

White round spots like soap bubbles appear on the recorded picture.

- If you take a picture with the flash in a dark place or indoors, white round spots may appear on the picture caused by the reflecting particles of dust in the air. This is not a malfunction.

A characteristic of this is that the number of round spots and their position differ in every picture.



Red parts of the recorded image are rendered black.

- When Red-Eye Removal ([], []) is in operation, if you take a picture of a subject with red color surrounded by a skin tone color, that red part may be corrected to black by the Red-Eye Removal function.
→ It is recommend to take picture with Flash Mode set to [A], [], or [], or [Red-Eye Removal] on the [Rec] menu set to [OFF]. (P138)

[Thumbnail is displayed] appears on the monitor.

- Is it a picture that has been recorded with other equipment? In such cases, these pictures may be displayed with a deteriorated picture quality.

A clicking sound is recorded in the motion pictures.

- The camera automatically adjusts the aperture during motion picture recording. At such times, a clicking sound is heard, and this sound may be recorded on the motion pictures. This is not a malfunction.
- The operational sound of the zoom or button operation may be recorded when it is operated during the recording of a motion picture.

Motion pictures recorded with this camera cannot be played back on other equipment.

- Motion pictures recorded in [AVCHD] or [MP4] may be played back with poor picture or sound quality or playback may not be possible even when played back with equipment compatible with these formats. Also, the recording information may not be displayed properly.

TV, computer and printer

The picture does not appear on the television.

- Is the camera connected to the TV correctly?
→ Set the TV input to external input mode.

The display areas on the TV screen and the camera's monitor are different.

- Depending on the TV model, the pictures may be extended horizontally or vertically or they may be displayed with their edges cut off.

Motion pictures cannot be played back on a TV.

- Are you trying to play back motion pictures by directly inserting the card in the card slot of the TV?
→ Connect the camera to the TV with the supplied AV cable, or with the HDMI mini cable (available as accessory, see P7), and then play back the motion pictures on the camera. (P167)

The picture is not displayed fully on the TV.

- Check [TV Aspect] setting. (P63)

HDTV Link does not work.

- Is it connected properly with the HDMI mini cable (available as accessory, see P7)? (P167)
→ Confirm that the HDMI mini cable is firmly fitted.
→ Press [▶] on the camera.
- Is the [HDTV Link] on the camera set to [ON]? (P63)
→ Depending on HDMI terminal of the TV, the input channel may not switch automatically. In this case, use the remote control for the TV to switch input. (For details on how to switch input, please read the instructions for the TV.)
→ Check the HDTV Link setting on the connected device.
→ Turn the camera off and on.
→ Set [HDAVI Control] to [Off] on the TV and then turn it back to [On]. (Refer to the instructions of the TV for details.)
→ Check [Video Out] setting. (P63) (With camera model 18 190)

Cannot communicate with the computer.

- Is the camera connected to the computer correctly?
- Is the camera recognized by the computer correctly?
 - Set to [PC] in [USB Mode]. (P62, 174)
 - Turn the camera off and on.

The card is not recognized by the computer. (The internal memory is recognized.)

- Disconnect the USB cable. Connect it again while the card is inserted in the camera.
- If there are two or more USB terminal on a single computer, try connecting the USB cable to another USB terminal.

The card is not recognized by the computer. (SDXC memory card is being used)

- Check if your computer is compatible with SDXC memory cards.
- A message prompting to format the card may be displayed when connecting, but do not format.
- If the [Access] displayed on the monitor does not disappear, disconnect the USB cable after turning the camera off.

The picture cannot be printed when the camera is connected to a printer.

- Pictures cannot be printed using a printer which does not support PictBridge.
 - Set to [PictBridge(PTP)] in [USB Mode]. (P62, 178)

The ends of the pictures are cut at printing.

- When using a printer with a cropping or borderless printing function, cancel this function before printing. (For details, refer to the operating instructions for the printer.)
- When you order photo studios to print pictures, ask the photo studio if the pictures can be printed with both ends.

The panorama picture is not printing correctly.

- Since aspect ratio of a panorama picture differs from normal pictures, it may not always be possible to print it correctly.
 - Please use a printer that supports panorama pictures. (For details, please see the operating instructions of your printer)
 - We recommend using the available software to adjust the size of the still picture to the print paper size.

Others



When shaking the camera, there is a rattling sound.

In the following cases, there is no problem with the camera, so do not worry.

- There is a rattling sound when the camera is shaken while the camera is turned off or during Playback Mode. (Sound of lens moving)
- The camera makes a rattling sound etc., when the camera is turned on or off, or when switching from Recording Mode to Playback Mode. (Sound of the aperture)
- Vibration is felt when zooming. (Movement of the lens barrel motor)
- When you hear a clicking or snapping sound from the lens while taking pictures. (The sound of the aperture adjusting to changes in light levels)

When this occurs, the image on the monitor may appear to change dramatically. However, the picture is not affected.

An unreadable language was selected by mistake.

→ Press [MENU/SET], select the [Setup] menu icon [] and then select the [] icon to set the desired language. (P65)

A red lamp sometimes turns on when the shutter release button is pressed halfway.

- In dark places, the AF Assist Lamp lights red to make it easier to focus on a subject.

Part of the picture is flashing in black and white.

- This is a highlight function showing the white saturated area. (P58)
- Is the [Highlight] set to [ON]?

The AF Assist Lamp does not turn on.

- Is [AF Assist Lamp] on the [Rec] menu set to [ON]? (P137)
- The AF Assist Lamp does not turn on in bright places.

The camera becomes warm.

- The surface of the camera may become warm during use. This does not affect the performance or quality of the camera.

The lens clicks.

- When the brightness changes due to zoom or camera movement etc., the lens may click and the picture on the screen may visibly change. However, the picture is not affected. The sound is caused by the automatic adjustment of the aperture. This is not a malfunction.

The clock is reset.

- If you do not use the camera for a long time, the clock may be reset.
→ [Please set the clock] message will be displayed; please re-set the clock. (P24)

Zooming stops instantaneously.

- When using the Extended Optical Zoom, the zooming action will stop temporarily. This is not a malfunction.

The file numbers are not recorded consecutively.

- When you perform an operation after taking a certain action, the pictures may be recorded in folders with different numbers from the ones used prior to the operation.

The file numbers are recorded with previously used numbers.

- If you insert or remove the battery before turning off the camera, the folder and file numbers for the pictures taken will not be stored in the memory. When the camera is turned on again and pictures are taken, they may be stored under file numbers which should have been assigned to previous pictures.

Leica Service Addresses

Leica information service

Should you have any technical questions regarding the use of Leica products or the software included in some cases, Leica information service will be happy to answer in writing or by phone, fax, or e-mail.

They are also your contact if you need advice concerning an acquisition or if you would like us to send you instructions.

Alternatively, you can also send us your questions through the contact form on the Leica Camera AG homepage.

Leica Camera AG

Information-Service / Software-Support

Postfach 1180

D-35599 Solms

Phone: +49 (0) 6442-208-111 / -108

Fax: +49 (0) 6442-208-490

info@leica-camera.com / software-support@leica-camera.com

Leica Customer Care

Leica AG's Customer Care center, or the repair service of the Leica national offices (see the Warranty Card for an address list), is available to assist you in maintaining your Leica equipment or in case of damage.

Please contact your nearest authorized Leica dealer.

Leica Camera AG

Customer Service

Solmsener Gewerbepark 8

D-35606 Solms

Phone: +49 (0) 6442-208-189

Fax: +49 (0) 6442-208-339

customer.care@leica-camera.com

- SDXC Logo is a trademark of SD-3C, LLC.
- “AVCHD”, “AVCHD Progressive” and the “AVCHD Progressive” logo are trademarks of Panasonic Corporation and Sony Corporation.
- Manufactured under license from Dolby Laboratories. Dolby and the double-D symbol are trademarks of Dolby Laboratories.
- HDMI, the HDMI Logo, and High-Definition Multimedia Interface are trademarks or registered trademarks of HDMI Licensing LLC in the United States and other countries.
- QuickTime and the QuickTime logo are trademarks or registered trademarks of Apple Inc., used under license therefrom.
- iMovie, Mac and Mac OS are trademarks of Apple Inc., registered in the U.S. and other countries.
- Leica is a registered trademark of Leica Microsystems IR GmbH.
- Elmarit is a registered trademark of Leica Camera AG.
- Windows and Windows Vista are either registered trademarks or trademarks of Microsoft Corporation in the United States and/or other countries.
- This camera uses “DynaFont” from DynaComware Corporation. DynaFont is a registered trademark of DynaComware Taiwan Inc.
- Adobe® Photoshop® Lightroom® is a registered trademark of Adobe Systems Incorporated.
- Other names of systems and products mentioned in these instructions are usually the registered trademarks or trademarks of the manufacturers who developed the system or product concerned.

AVCHD™
Progressive

DOLBY
DIGITAL

HDMI



This product is licensed under the AVC patent portfolio license for the personal and non-commercial use of a consumer to (i) encode video in compliance with the AVC Standard (“AVC Video”) and/or (ii) decode AVC Video that was encoded by a consumer engaged in a personal and non-commercial activity and/or was obtained from a video provider licensed to provide AVC Video. No license is granted or shall be implied for any other use. Additional information may be obtained from MPEG LA, LLC. See <http://www.mpegla.com>.

Copying the recorded image data to a computer with the available software

Using the Adobe® Photoshop® Lightroom® software (available for download, see below), you can import the image data recorded with this camera in all file formats to a computer - for still and motion pictures.

Three preparatory steps are necessary when initially installing the software to utilize it.

1 Install the software to your computer

2 Register your camera on the Leica Camera AG homepage

- a. Open an account at <http://owners.leica-camera.com>. As a result, you will receive access to the "Owners area".
- b. Register your camera at "My products" by entering its serial number. Do so by following the respective instructions.
- c. Then select "...software download...". You will be requested to enter the TAN code which you will find on a sticker on the Warranty Card.

- The key with which you can activate the software will be sent to you by email.

3 Activate the software with the key (numbers) you have received

- Do so by following the respective instructions appearing after opening the software.

■ Using the software

1 Connect the camera to your computer

2 Use Adobe® Photoshop® Lightroom® to copy still and motion pictures to your computer

- For details on how to operate the software, refer to the online assistance.

- Files and folders containing copied AVCHD motion pictures cannot be played back or edited if they have been deleted, modified, or moved using Windows Explorer or similar methods.



my point of view